



NOS ATOUTS:

QUALITÉ - DISPONIBILITÉ - RÉACTIVITÉ

Spécialisés dans la fabrication et la commercialisation d'instruments chirurgicaux, nous proposons 4 gammes de dispositifs médicaux:

IN'SURG STANDARD

Instruments chirurgicaux d'usages courants toutes spécialités chirurgicales confondues.

Garantie totale
5 ANS
sans conditions

IN'SURG ULTRA LINE

Ciseaux lame sabre et lame crantée (ciseaux dissecteurs, vasculaires etc...) :

AFFUTAGE GRATUIT LES 5 PREMIERES ANNEES

Porte-aiguilles (boitier monobloc),

Pincés hémostatiques et nos passe fils (dissecteurs),

Pincés à disséquer (assemblage par soudure laser).

Garantie totale
10 ANS
sans conditions

IN'SURG OPEN LINE

Nos rongeurs et pincés à disque destinés aux interventions sur le rachis.

DÉMONTABLES NON DÉTACHABLES.

Garantie totale
5 ANS
sans conditions

IN'SURG TITAN ULTRA

Instruments de microchirurgie tels que :

Porte-aiguilles TITAN corps ronds, corps plats, avec ou sans verrou....

Ciseaux TITAN corps en titane avec ou sans contre poids, double articulation....

Pincés à disséquer TITAN (DEBAKEY, avec ou sans griffe, avec ou sans plateau...)

Garantie totale
2 ANS
sans conditions

Grâce à nos **6000 références** disponibles en stock, nous vous proposons un vaste choix de dispositifs médicaux couvrant l'ensemble des spécialités chirurgicales.

NOTRE SAVOIR-FAIRE :

- ▲ Une équipe composée d'experts disposant de 25 ans d'expériences dans l'instrumentation chirurgicale.
- ▲ Contrôle qualité unitaire sur 100% de nos produits.
- ▲ La disponibilité afin de répondre à vos demandes dans les meilleurs délais : Devis et livraison, en 24 / 48h.
- ▲ L'écoute active pour répondre à vos besoins et vous accompagner au quotidien (conseil, audit, formation...)
- ▲ La transparence : Stock en temps réel sur nos devis, nos confirmations de commandes et sur notre site www.in-surg.fr
- ▲ Des dispositifs médicaux marqués CE, au prix du marché, présents en France et à l'international.
- ▲ L'intégration de la qualité dans la stratégie globale de la société.

Certifiée NF EN ISO 13485 depuis 2021, ce référentiel nous permet :

- De garantir la maîtrise du système de management de la qualité.
- De démontrer le respect des exigences des clients, des exigences normatives et réglementaires.
- D'assurer la sécurité de tous nos processus de fabrication.
- D'engager la mise en œuvre du nouveau règlement (UE) 2017 / 745 (MDR Médical Device Regulation).

Consciente des enjeux de la Responsabilité Sociétale des Entreprises (RSE), IN'SURG s'est engagée dans une démarche Eco-responsable et déploie en son sein des actions visant à minimiser son impact environnemental.

NOS PARTENAIRES





L'INSTRUMENT CHIRURGICAL
QUI VOUS CORRESPOND

BESOIN D'INFORMATIONS ?

NEED MORE INFORMATION ?

DIRECTION : direction@in-surg.fr

SERVICE PRODUITS : produits@in-surg.fr

SERVICE QUALITE ET AFFAIRES REGLEMENTAIRES : qualite@in-surg.fr

SERVICE COMMERCIAL : commercial@in-surg.fr

SERVICE ADV : contact@in-surg.fr

SERVICE APRES VENTE ET LOGISTIQUE : sav@in-surg.fr

GUIDE DES PICTOGRAMMES ET DE LEURS SIGNIFICATIONS

GUIDE TO PICTOGRAMS AND THEIR MEANING



EN COURS DE FABRICATION ANNEE 2024

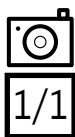

ILLUSTRATION EN TAILLE REELLE

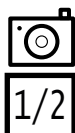
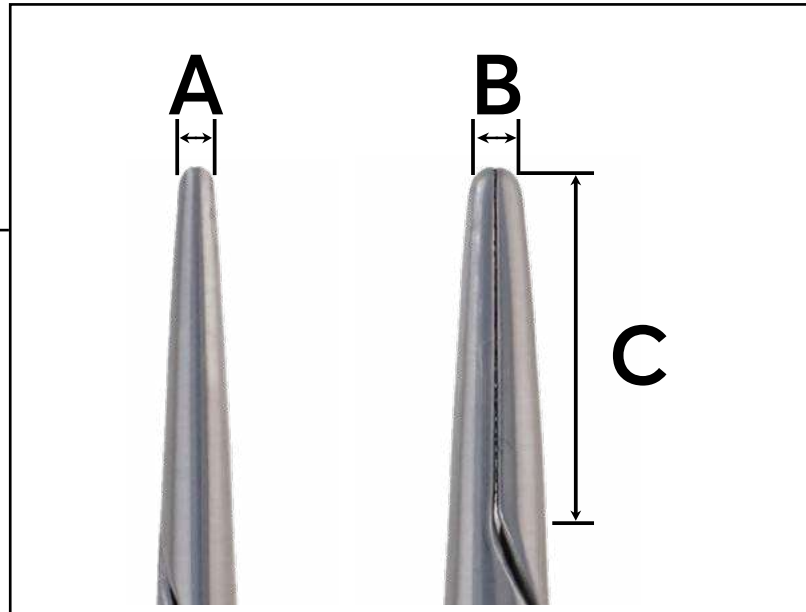

ILLUSTRATION A L'ECHELLE 1/2

LECTURE DES DIMENSIONS

READING DIMENSIONS

P355161 : PORTE AIGUILLE MICRO CASTROJIEVO 1,3 X 2 X 12 X 180 MM DROIT CORPS ROND
A VERROU MORS DIAMANTES



A = EPAISSEUR
THICKNESS

B = LARGEUR
WIDTH

C = LONGUEUR
LENGTH



EXEMPLE : 1,3 X 2 X 12 MM

A B C

Le fonctionnement est identique pour l'ensemble de notre gamme micro (porte aiguille standard ou titane, ciseaux standard ou titane)

THE UNDERSTANDING IS EXACTLY THE SAME FOR ALL «MICRO» RANGE (MICRO NEEDLE HOLDER STANDARD OR TITAN, MICRO SCISSORS STANDARD OR TITAN).

SOMMAIRE

A

ABAISSÉ LANGUE	15
<i>TONGUE DEPRESSOR</i>	
AGRAFE (IMPACTEUR/PORTE AGRAFE)	18
<i>CLIP (IMPACTOR/CLIP HOLDER)</i>	
AGRAFE (PINCE A)	21
<i>CLIP (FORCEPS WITH)</i>	
AIGUILLE	22
<i>NEEDLE</i>	
ALENE DE REDON	35
<i>REDON ALENE</i>	
ALESOIR	36
<i>REAMER</i>	
AMYGDALOTOME	38
<i>AMYGDALOTOME</i>	
ANNEAUX ENDARTERIECTOMIE	39
<i>ENDARTERIECTOMY RING</i>	
ANSE	40
<i>LOOP</i>	
ANUSCOPE	41
<i>ANUSCOPE</i>	

B

BISTOURI	45
<i>SCALPEL</i>	
BOUGIE	52
<i>BOUGIE</i>	

C

CADRE EPINGLE PORTE PINCES	61
<i>INSTRUMENTS HOLDER FRAME</i>	
CANULE	63
<i>CANNULA</i>	
CHASSE GREFFONS	72
<i>TAMPERS GRAFT</i>	
CHAUSSE - VEINE	76
<i>VEIN INSERTER</i>	
CISAILLE	77
<i>SHEAR</i>	
CINTREUSE	82
<i>BENDER</i>	
CISEAU A OS :	
BURIN	83
<i>BONE CHISEL</i>	
GOUGE	99
<i>BONE GOUGE</i>	
OSTEOTOME	121
<i>BONE OSTEOTOME</i>	
CISEAUX :	
CAPSULAIRE	134
<i>CAPSULAR SCISSORS</i>	
COURANTS	136
<i>SCISSORS</i>	
DISSECTEURS	160
<i>DISSECTING SCISSORS</i>	
ENTEROTOMES	184
<i>ENTEROTOMY SCISSORS</i>	

FILS	185
<i>WIRE SCISSORS</i>	
GYNECO	187
<i>GYNECO SCISSORS</i>	
MICRO	197
<i>MICRO SCISSORS</i>	
NEURO	202
<i>NEURO SCISSORS</i>	
O.R.L	204
<i>E.N.T SCISSORS</i>	
ONGLES	227
<i>NAILS SCISSORS</i>	
PANSEMENT	228
<i>BANDAGE SCISSORS</i>	
RECTUM	232
<i>RECTUM SCISSORS</i>	
VASCULAIRE	233
<i>VASCULAR SCISSORS</i>	
CLAMP BARR	242
<i>BARR CLAMP</i>	
CLAMP BULLDOG	243
<i>BULLDOG CLAMP</i>	
CLAMP DIGESTIF	248
<i>DIGESTIVE CLAMP</i>	
CLAMP VASCULAIRE :	
ANASTOMOSE	268
<i>ANASTOMOSIS VASCULAR CLAMP</i>	
AORTIQUE	272
<i>AORTIC VASCULAR CLAMP</i>	
AURICULAIRE	287
<i>ATRIAL VASCULAR CLAMP</i>	
BRONCHES	288
<i>BRONCHIAL VASCULAR CLAMP</i>	
BULLDOG (A CREMAILLERE)	291
<i>BULLDOG VASCULAR CLAMP (WITH RATCHET)</i>	
CAROTIDES	293
<i>CAROTID VASCULAR CLAMP</i>	
COARCTATION	295
<i>COARCTATION VASCULAR CLAMP</i>	
ILIAQUE	303
<i>ILIAC VASCULAR CLAMP</i>	
LIGATURE DISSECTION	304
<i>LIGATURE DISSECTION VASCULAR CLAMP</i>	
MULTIPOSE	305
<i>MULTIPOSE VASCULAR CLAMP</i>	
OCCLUSION TANGENTIELLE	309
<i>TANGENTIAL OCCLUSION VASCULAR CLAMP</i>	
PEDIATRIQUE	311
<i>PEDIATRIC VASCULAR CLAMP</i>	
PERIPHERIQUE	315
<i>VASCULAR CLAMP PERIPHERAL</i>	
RENAL	323
<i>RENAL VASCULAR CLAMP</i>	
CLE CAMBRAGE / PLATE	324
<i>CAMBER / FLAT KEY</i>	
CLIPS (PINCE A POSER)	325
<i>CLIPS (FORCEPS FOR PLACING)</i>	

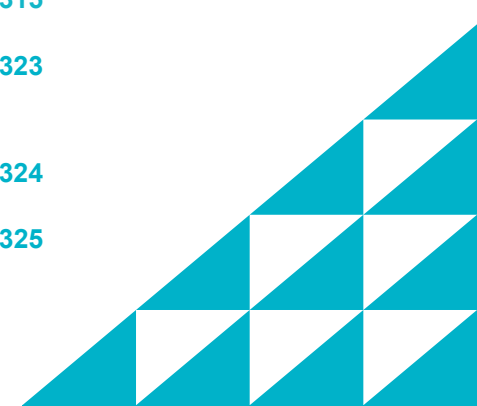

C

COMPRESSEUR	326
<i>COMPRESSOR</i>	
COSTOTOME	327
<i>RIB SHEAR</i>	
COUTEAU :	
AMPUTATION	333
<i>AMPUTATION KNIFE</i>	
MENISQUE	334
<i>MENISCUS KNIFE</i>	
NEURO	335
<i>NEURO KNIFE</i>	
O.R.L	339
<i>E.N.T KNIFE</i>	
PLATRE	345
<i>PLASTER KNIFE</i>	
CROCHET	346
<i>HOOK</i>	
CUPULE	374
<i>CUP</i>	
CURETTE :	
CALCULS BILIAIRES	375
<i>GALLSTONE CURETTE</i>	
CALCULS RENAUX	378
<i>KIDNEY STONE CURETTE</i>	
DERMATO	379
<i>DERMATO CURETTE</i>	
GYNECO	381
<i>GYNECO CURETTE</i>	
NEURO	395
<i>NEURO CURETTE</i>	
O.R.L	400
<i>E.N.T CURETTE</i>	
OSSEUSE	411
<i>BONE CURETTE</i>	
D	
DAVIER	435
<i>BONE HOLDING FORCEPS</i>	
DECOLLEUR	456
<i>BREAKER</i>	
DERMATOME	458
<i>DERMATOME</i>	
DILATATEUR :	
NEURO	459
<i>NEURO DILATATOR</i>	
RECTAL	460
<i>RECTAL DILATATOR</i>	
TRACHEAL	466
<i>TRACHEAL DILATATOR</i>	
VASCULAIRE	468
<i>VASCULAR DILATATOR</i>	
VOIES BILIAIRES	470
<i>GALL DUCT DILATATOR</i>	

DISSECTEUR	471
<i>DISSECTOR</i>	

E

ECARTEUR :	
(SUR MANCHE)	489
<i>HANDLE RETRACTOR</i>	
ABDOMINAL	555
<i>ABDOMINAL RETRACTOR</i>	
AUTOSTATIQUE	578
<i>AUTOSTATIC RETRACTOR</i>	
AUTOSTATIQUE CASPAR	627
<i>CASPAR AUTOSTATIC RETRACTOR</i>	
AUTOSTATIQUE CLOWARD	639
<i>CLOWARD AUTOSTATIC RETRACTOR</i>	
AUTOSTATIQUE SCOVILLE HAVERFIELD	645
<i>SCOVILLE HAVERFIELD AUTOSTATIC RETRACTOR</i>	
DOUBLE	647
<i>DOUBLE RETRACTOR</i>	
THORACIQUE	659
<i>THORACIC RETRACTOR</i>	
ECRASEUR/ETAU	666
<i>INTESTINAL AND PYLORUS CLAMPS</i>	
ELEVATEUR	668
<i>ELEVATOR</i>	
ETRIER	674
<i>TRACTIONS BOWS</i>	
EXTRACTEUR	677
<i>EXTRACTOR</i>	

F

FORCEPS	681
<i>OBSTETRICAL FORCEPS</i>	
FOURCHE	690
<i>FORK</i>	

G

GUIDE MECHE	693
<i>DRILL GUIDE</i>	

H

HYSTEROMETRE	697
<i>UTERINES PROBES</i>	

L

LAME MALLEABLE	701
<i>MALLEABLE BLADE</i>	
LEVIER	704
<i>LEVER</i>	

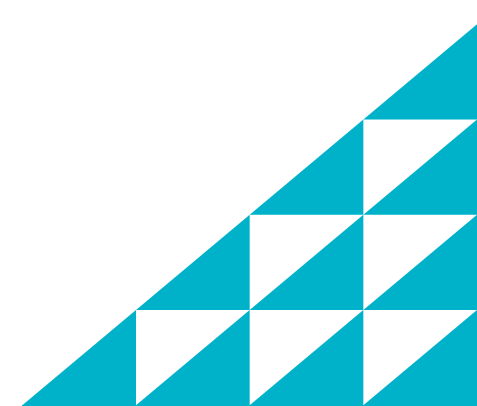

M

MAILLET	707
<i>MALLET</i>	
MAIN DE TUPPERS	713
<i>TUPPERS HAND</i>	
MAMOSTAT	714
<i>MAMOSTAT</i>	
MANDRIN	716
<i>MANDREL</i>	
MARTEAU	718
<i>HAMMER</i>	
MASSE	721
<i>MASSE</i>	
MIROIR	722
<i>MIRROR</i>	

O

OUVRE BOUCHE	725
<i>MOUTH GAGS</i>	

P

PASSE FILS	731
<i>WIRE GUIDE</i>	
PEIGNE	744
<i>COMB</i>	
PERFORATEUR	745
<i>HAND HELD JACKHAMMER</i>	
PINCE A COURBER / TORSADER	749
<i>BEND / TWIST FORCEPS</i>	
PINCE A BIOPSIE GYNECO	750
<i>GYNECO BIOPSY FORCEPS</i>	
PINCE A CALCULS	760
<i>GALL STONE FORCEPS</i>	
PINCE CHAMPS	764
<i>TOWEL CLAMPS</i>	
PINCE A COAGULATION	770
<i>COAGULATION FORCEPS</i>	
PINCE COUPANTE :	
DOUBLE ARTICULATION	783
<i>CUTTING PLIERS DOUBLE ARTICULATION</i>	
SIMPLE ARTICULATION	788
<i>CUTTING PLIERS SINGLE ARTICULATION</i>	
PINCE A DISSEQUER	795
<i>DISSECTING FORCEPS</i>	
PINCE DIVERSE :	
(A DRAINS)	839
<i>VARIOUS FORCEPS (EMPTY THE DRAIN)</i>	
(INTUBATION)	840
<i>VARIOUS FORCEPS (INTUBATION)</i>	
(PROTEGE CUECUM)	841
<i>VARIOUS FORCEPS (PROTECT CUECUM)</i>	
PINCE A ECHARDES	842
<i>SPLINTER FORCEPS</i>	

PINCE A EPILER	844
<i>TWEEZER</i>	
PINCE COUPE FILS	845
<i>WIRE CUTTING PLIERS</i>	
PINCE FILS EXTRACTION	852
<i>WIRE EXTRACTION PLIERS</i>	
PINCE FILS PREHENSION	857
<i>WIRE PREHENSION PLIERS</i>	
PINCE GOUGE :	
DOUBLE ARTICULATION	860
<i>BONE RONGEUR DOUBLE ARTICULATION</i>	
SIMPLE ARTICULATION	875
<i>BONE RONGEUR SINGLE ARTICULATION</i>	
PINCE GYNECO	893
<i>GYNECO FORCEPS</i>	
PINCE HEMOSTATIQUE	915
<i>HEMOSTATIC FORCEPS</i>	
PINCE MENISQUE	957
<i>MENISCUS FORCEPS</i>	
PINCE NEURO MICRO	960
<i>MICRO NEURO FORCEPS</i>	
PINCE ONGLES	961
<i>NAILS FORCEPS</i>	
PINCE ORL :	
AMYGDALES	962
<i>ENT FORCEPS - TONSIL</i>	
OTOLOGIE	964
<i>ENT FORCEPS - OTOLOGY</i>	
RHINOLOGIE	968
<i>ENT FORCEPS - RHINOLOGY</i>	
TIRE LANGUE	976
<i>ENT FORCEPS - TONGUE HOLDING FORCEPS</i>	
PINCE PANSEMENT	977
<i>DRESSING FORCEPS</i>	
PINCE PERFORANTE	987
<i>PERFORATING FORCEPS</i>	
PINCE PLATRE	988
<i>PLASTER CAST BREAKER FORCEPS</i>	
PINCE PREHENSION	991
<i>GRASPING FORCEPS</i>	
PINCE PRESSE TUBE	1004
<i>TUBING CLAMPS</i>	
PINCE PROSTATIQUE	1006
<i>PROSTATIC FORCEPS</i>	
PINCE TENDONS	1007
<i>TENDONS FORCEPS</i>	
POIGNEE	1009
<i>HANDLE</i>	
POINTE BANKART	1010
<i>BANKART TIP</i>	
POINTE CARREE	1011
<i>DRILL SQUARE</i>	
PORTE AIGUILLE	1016
<i>NEEDLE HOLDER</i>	

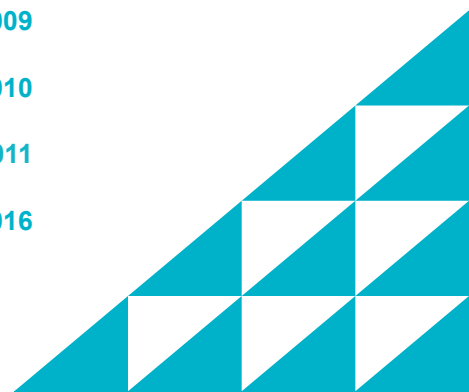

PORTE AIGUILLE MICRO	1045
<i>NEEDLE HOLDER</i>	
PORTE COTON	1061
<i>COTON APPLICATOR</i>	
PORTE VIS	1063
<i>SCREW HOLDER</i>	
PROTECTEUR SILICONE	1064
<i>SILICONE PROTECTION</i>	

R

RAPE	1067
<i>RASP</i>	
RAPPROCHEUR COSTAL	1073
<i>RIBS APPROXIMATOR</i>	
REFOULOIR	1074
<i>RAMMER</i>	
ROND DE SEIN	1075
<i>ROUND BREAST</i>	
RONGEUR :	
(PINCE A) DISQUE	1076
<i>DISC RONGEUR</i>	
HYPOPHYSE	1085
<i>HYPOPHYSIS RONGEUR</i>	
LAME VERTEBRALES	1086
<i>LAMINECTOMY RONGEUR</i>	
ORL	1088
<i>ENT RONGEUR</i>	
RUBAN IDENTIFICATEUR	1089
<i>AUTOCLAVABLE IDENTIFICATION TAPE THE ROLL</i>	
RUGINE	1090
<i>RASPATORY</i>	

S

SCIE	1117
<i>SAW</i>	
SEMELLE	1123
<i>SOLE</i>	
SERRE FIL	1124
<i>WIRE TIGHTENER</i>	
SERRE NOEUDS	1126
<i>SNARES</i>	
SONDE	1129
<i>PROBE</i>	
SPATULE	1131
<i>SPATULA</i>	
SPECULUM :	
GYNECO	1135
<i>VAGINAL SPECULA</i>	
ORL	1142
<i>ENT SPECULA</i>	
TRANSPHENOIDALE	1148
<i>TRANSPHENOIDAL SPECULA</i>	

STERILISATION PANIER ET CALAGE	1154
<i>BASKET AND WEDGE</i>	
STRIPPER	1149
<i>STRIPPER</i>	
STYLET	1150
<i>STYLUS</i>	

T

TIRE COMEDON - TIRE FIBROME	1199
<i>COMEDON EXTRACTOR - MYOMA SCREW</i>	

TITAN ULTRA :

CANULE	1200
<i>TITAN - SUCTION CANNULA</i>	
CISEAUX CORPS PLAT	1202
<i>TITAN - SCISSORS FLAT BODY</i>	
CISEAUX CORPS ROND	1210
<i>TITAN- SCISSORS ROUND BODY</i>	
CLAMP BULLDOG	1220
<i>TITAN- BULLDOG CLAMP</i>	
CROCHET / COUTEAU	1221
<i>TITAN - HOOK</i>	
CURETTE	1223
<i>TITAN - CURETTE</i>	
DILATATEUR	1224
<i>TITAN - DILATATOR</i>	
PINCE A DISSEQUER CORPS PLAT	1225
<i>TITAN- DISSECTING FORCEPS FLAT BODY</i>	
PINCE A DISSEQUER CORPS ROND	1230
<i>TITAN - DISSECTING FORCEPS ROUND BODY</i>	
PORTE AIGUILLE CORPS PLAT	1240
<i>TITAN - NEEDLE HOLDER FLAT BODY</i>	
PORTE AIGUILLE CORPS ROND	1243
<i>TITAN - NEEDLE HOLDER ROUND BODY</i>	
RUGINE	1248
<i>TITAN - RASPATORY</i>	
SET VASCULAIRE	1249
<i>TITAN VASCULAR SET</i>	
TORD BROCHE	1251
<i>TWIST PIN</i>	
TOURNEVIS	1252
<i>SCREWDRIVER</i>	
TOURNIQUET	1253
<i>TOURNIQUET</i>	
TREPAN	1254
<i>HAND DRILLS</i>	

V

VALVE	1261
<i>VALVE</i>	
VENTOUSE OBSTETRICALE	1276
<i>OBSTETRICAL VACUUM</i>	



SOMMAIRE

ABAISSÉ LANGUE	15
<i>TONGUE DEPRESSOR</i>	
AGRAFE (IMPACTEUR/PORTE AGRAFE)	18
<i>CLIP (IMPACTOR/CLIP HOLDER)</i>	
AGRAFE (PINCE A)	21
<i>CLIP (FORCEPS WITH)</i>	
AIGUILLE	22
<i>NEEDLE</i>	
ALENE DE REDON	35
<i>REDON ALENE</i>	
ALESOIR	36
<i>REAMER</i>	
AMYGDALOTOME	38
<i>AMYGDALOTOME</i>	
ANNEAUX ENDARTERIECTOMIE	39
<i>ENDARTERIECTOMY RING</i>	
ANSE	40
<i>LOOP</i>	
ANUSCOPE	41
<i>ANUSCOPE</i>	



A

RETRO 'SPECTIVE

Alois ALZHEIMER
(14 juin 1864 - 19 décembre 1915)

était un **Neuropsychiatre** Allemand,
connu pour sa description en 1906 de
**la maladie qui porte à présent son
nom.**

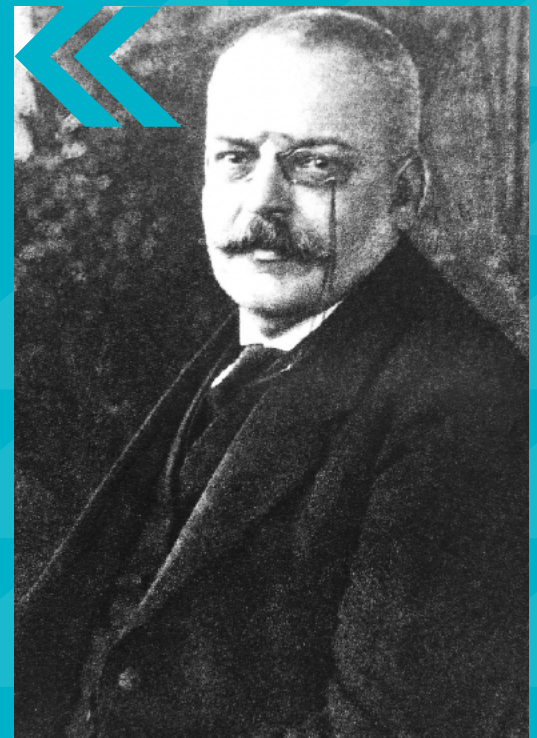

ABAISSSE LANGUE

TONGUE DEPRESSOR

ABAISSSE LANGUE CHATELLIER 20 X 220 MM

A010001 CHATELLIER TONGUE DEPRESSOR 20 X 220 MM

ABAISSSE LANGUE LE COUTEUR 160 MM

A010006 LE COUTEUR TONGUE DEPRESSOR 160 MM



A010002
25 X 220 MM

A010003
30 X 220 MM

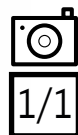
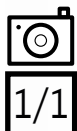

ABASSE LANGUE DOYEN ADULTE DOUBLE

A010004 *DOYEN TONGUE DEPRESSOR ADULT DOUBLE*

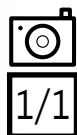

ABASSE LANGUE DOYEN ENFANT DOUBLE

A010005 *DOYEN TONGUE DEPRESSOR CHILDREN DOUBLE*



ABAISSE LANGUE

TONGUE DEPRESSOR

ABAISSE LANGUE LE MEE AVEC ASPIRATION

A010007 LE MEE TONGUE DEPRESSOR
WITH SUCTION

ABAISSE LANGUE REICHERT 240 MM

A010008 REICHERT TONGUE DEPRESSOR 240 MM



AGRAFE (IMPACTEUR/PORTE AGRAFE)

CLIP (IMPACTOR/CLIP HOLDER)

A

IMPACTEUR AGRAFE BLOUNT

A020010 BLOUNT CLIP IMPACTOR

PORTE AGRAFE BLOUNT

A020011 BLOUNT CLIP HOLDER

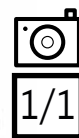
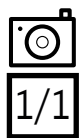

AGRAFE (PINCE À)

CLIP (FORCEPS WITH)

PINCE A POSER AGRAFE MICHEL 160 MM

A020019 MICHEL STAPLES APPLYING FORCEPS 160 MM

PINCE AGRAFE MICHEL MAGASIN 20 MM A AFFRONTER

A020016 MICHEL STAPLES HOLDER FORCEPS WITH STORE FOR STAPLES 20 MM



A020018
130 MM



A020012
12 MM

A020013
14 MM

A020014
16 MM

A020015
18 MM

PINCE AGRAFE MICHEL 120 MM DOUBLE USAGE

A020022 MICHEL STAPLE FORCEPS DOUBLE USE 120MM

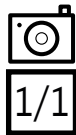

PINCE A OTER AGRAFE MICHEL 130 MM

A020021 MICHEL STAPLES EXTRACTION FORCEPS 130 MM



AGRAFE (PINCE À)

CLIP (FORCEPS WITH)

PINCE A OTER AGRAFE HEATH 130 MM

A020020 HEATH STAPLES EXTRACTION FORCEPS
130 MM

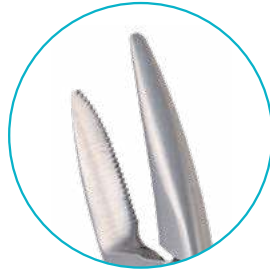

PINCE AGRAFE 120 MM BRUNON-HEGENBART

A020017 BRUNON-HEGENBART STAPLES
APPLYING FORCEPS 120 MM

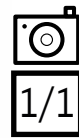
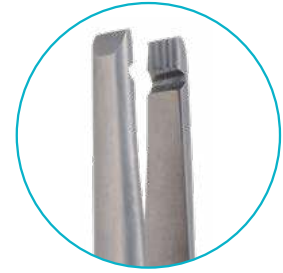

AIGUILLE

NEEDLE

www.in-surg.fr

A

MANCHE POUR AIGUILLE PARACENTESE POLITZER

A030028 *POLITZER HANDLE FOR MYRINGOTOME*



AIGUILLE PARACENTESE POLITZER ENFANT

A030027 *POLITZER MYRINGOTOME CHILDREN*

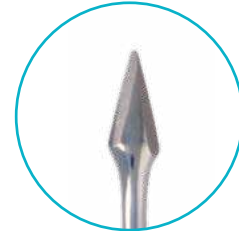

AIGUILLE PARACENTESE POLITZER ADOLESCENT

A030025 *POLITZER MYRINGOTOME TEENAGER*

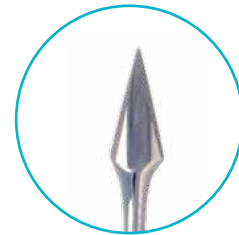

AIGUILLE PARACENTESE POLITZER ADULTE

A030026 *POLITZER MYRINGOTOME ADULT*



AIGUILLE CORPS ETRANGERS DUPUYTREN DROITE

A030024 *DUPUYTREN NEEDLE FOR FOREIGN BODY STRAIGHT*



A020023
COURBE
CURVED

AIGUILLE

NEEDLE

AIGUILLE SUTURE REVERDIN
150 MM INTESTINALE DROITE

A030033 REVERDIN INTESTINAL
SUTURE NEEDLE
150 MM STRAIGHT

AIGUILLE SUTURE REVERDIN
150 MM INTESTINALE DEMIE
COURBE

A030032 REVERDIN INTESTINAL
SUTURE NEEDLE 150 MM
DEMI CURVED

AIGUILLE SUTURE REVERDIN
150 MM INTESTINALE COURBE

A030031 REVERDIN INTESTINAL
SUTURE NEEDLE
150 MM CURVED

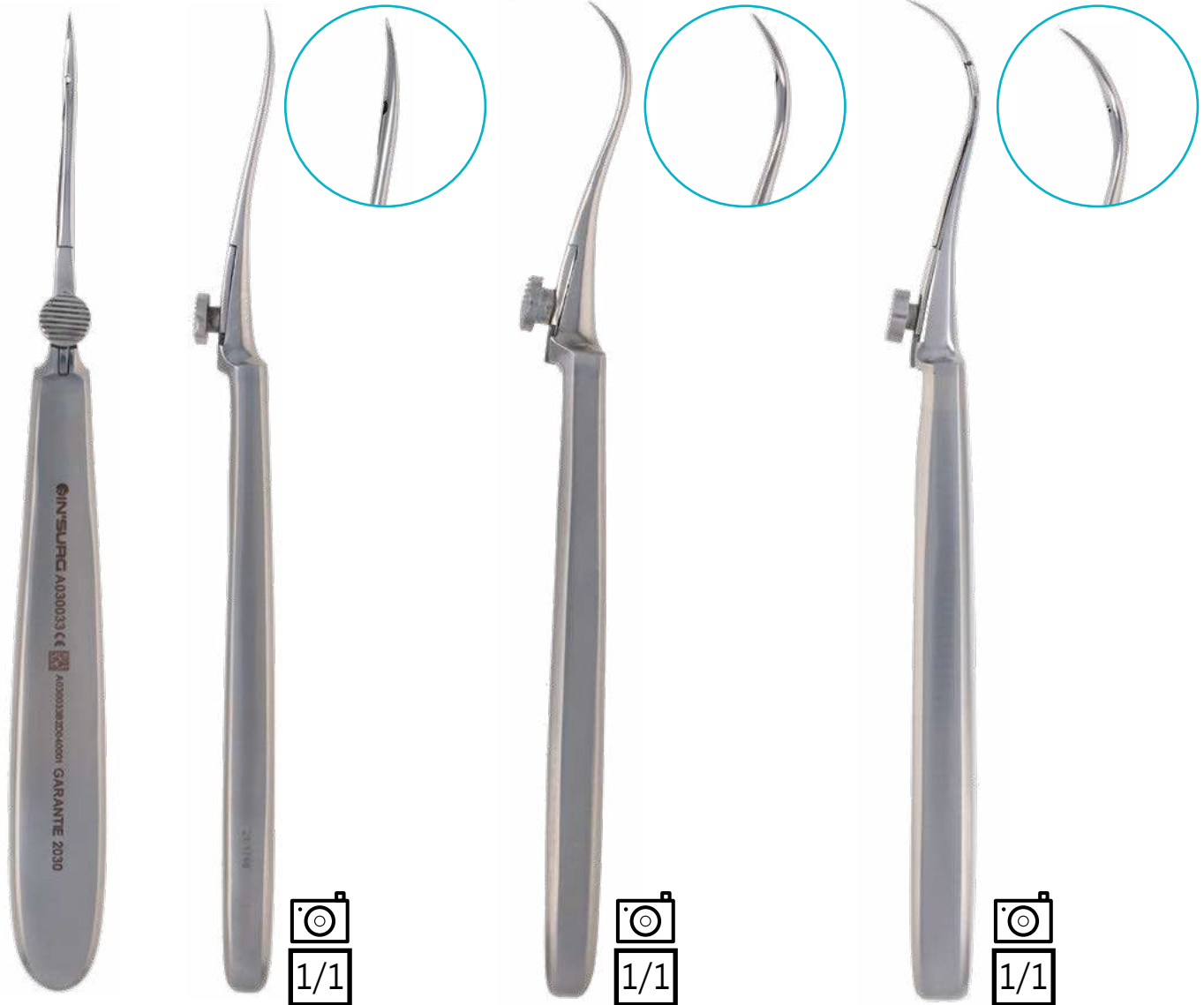

AIGUILLE SUTURE MOYENNE REVERDIN 190 MM DROITE
A030036 REVERDIN MIDDLE SIZE SUTURE NEEDLE 190 MM STRAIGHT

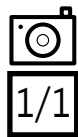

AIGUILLE SUTURE MOYENNE REVERDIN 190 MM DEMIE COURBE
A030035 REVERDIN MIDDLE SIZE SUTURE NEEDLE 190 MM DEMI CURVED



AIGUILLE SUTURE MOYENNE REVERDIN 190 MM COURBE
A030034 REVERDIN MIDDLE SIZE SUTURE NEEDLE 190 MM CURVED



AIGUILLE SUTURE MOYENNE REVERDIN 190 MM TRES COURBE
A030037 REVERDIN MIDDLE SIZE SUTURE NEEDLE 190 MM VERY CURVED



AIGUILLE SUTURE REVERDIN 220 MM DEMIE COURBE A PAROI

A030039 REVERDIN MEMBRANE SUTURE NEEDLE 220 MM DEMI CURVED

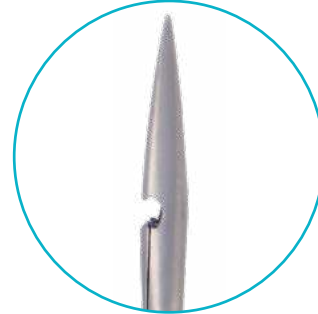

AIGUILLE SUTURE REVERDIN 220 MM COURBE A PAROI

A030038 REVERDIN MEMBRANE SUTURE NEEDLE
220 MM CURVED

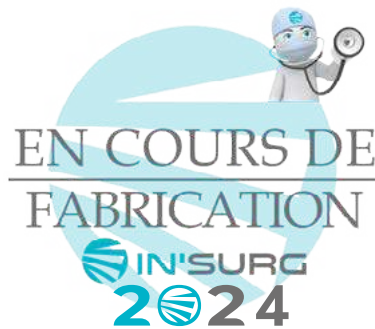

AIGUILLE SUTURE REVERDIN 220 MM TRES COURBE A PAROI

A030040 REVERDIN MEMBRANE SUTURE NEEDLE 220 MM VERY CURVED

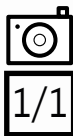

**AIGUILLE SUTURE PASSE FILS BRUNNER
300 MM GRANDE COURBURE**

A030043 BRUNNER SUTURE NEEDLE FORCEPS
300 MM LARGE CURVED

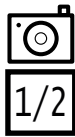

**AIGUILLE SUTURE PASSE FILS COOPER 190 MM
A030045 COOPER SUTURE NEEDLE FORCEPS 190 MM**



**AIGUILLE SUTURE PASSE FILS BRUNNER
300 MM PETITE COURBURE
A030044 BRUNNER SUTURE NEEDLE FORCEPS
300 MM SMALL CURVED**

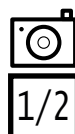

AIGUILLE NEEDLE

AIGUILLE SUTURE PASSE FILS DESCHAMPS 230 MM COUDEE A DROITE MOUSSE
A030053 *DESCHAMPS SUTURE NEEDLE FORCEPS 230 MM RIGHT-ANGLED BLUNT*



EXTREMITE MOUSSE BLUNT END



COUDEE A DROITE
RIGHT ANGLED

COUDEE A GAUCHE
LEFT ANGLED

LONGUEUR
LENGTH

200 MM

A030049

A030050

230 MM

A030053

A030054

EXTREMITE POINTUE SHARP END



COUDEE A DROITE
RIGHT ANGLED

COUDEE A GAUCHE
LEFT ANGLED

LONGUEUR
LENGTH

210 MM

A030051

A030052

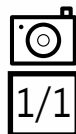

AIGUILLE SUTURE PASSE FILS DESCHAMPS SHAUTA 280 MM COUDEE A DROITE
A030055 *DESCHAMPS SHAUTA SUTURE NEEDLE FORCEPS 280 MM RIGHT-ANGLED*

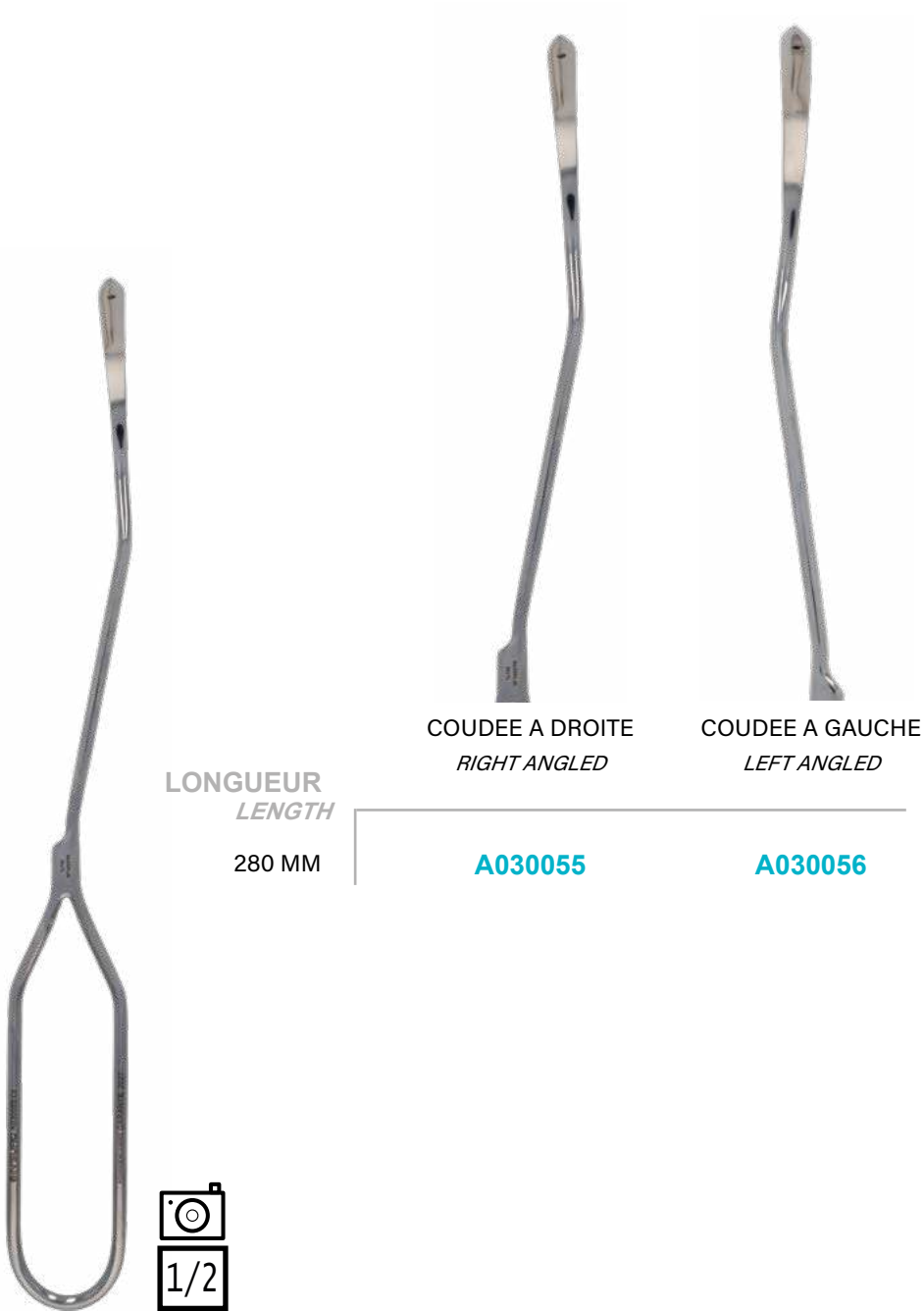

AIGUILLE NEEDLE

AIGUILLE SUTURE PASSE FILS DOYEN 185 MM COURBURE DELICATE
A030057 DOYEN SUTURE NEEDLE FORCEPS 185 MM DELICATE CURVED



AIGUILLE SUTURE PASSE FILS DOYEN 185 MM COURBURE ORDINAIRE
A030058 DOYEN SUTURE NEEDLE FORCEPS 185 MM NORMAL CURVED



AIGUILLE SUTURE PASSE FILS DOYEN
 185 MM TRES COURBE
A030059 DOYEN SUTURE NEEDLE
 FORCEPS 185 MM VERY CURVED



AIGUILLE SUTURE PASSE
FILS EMMET 200 MM PETIT
MODELE

A030062 *EMMET SUTURE
NEEDLE FORCEPS
200 MM
SMALL SAMPLE*

AIGUILLE SUTURE PASSE
FILS EMMET 200 MM MOYEN
MODELE

A030061 *EMMET SUTURE NEEDLE
FORCEPS 200 MM MEDIUM
SAMPLE*

AIGUILLE SUTURE PASSE FILS
EMMET 200 MM GRAND MODELE

A030060 *EMMET SUTURE NEEDLE
FORCEPS 200 MM LARGE
SAMPLE*



AIGUILLE NEEDLE



AIGUILLE SUTURE PASSE FILS HUET 50 X 250 MM
MOYEN MODELE A DROITE

A030063 HUET SUTURE NEEDLE FORCEPS 50 X 250 MM MEDIUM
SAMPLE RIGHT CURVATURE

COURBURE A DROITE RIGHT CURVATURE



PETIT MODELE
SMALL SAMPLE



MOYEN MODELE
MEDIUM SAMPLE



GRAND MODELE
LARGE SAMPLE

LONGUEUR
LENGTH

250 MM

40 MM

A030065

50 MM

A030063

60 MM

A030064

COURBURE A GAUCHE LEFT CURVATURE



PETIT MODELE
SMALL SAMPLE



MOYEN MODELE
MEDIUM SAMPLE



GRAND MODELE
LARGE SAMPLE

LONGUEUR
LENGTH

250 MM

40 MM

A030068

50 MM

A030067

60 MM

A030066

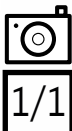

AIGUILLE SUTURE PASSE FILS KELSEY FRY
150 MM MAXILLO FACIAL

A030069 KELSEY FRY SUTURE NEEDLE FORCEPS
150 MM MAXILLARY



AIGUILLE SUTURE PASSE FILS KELSEY FRY
180 MM MAXILLO FACIAL

A030070 KELSEY FRY SUTURE NEEDLE FORCEPS
180 MM MAXILLARY



AIGUILLE NEEDLE

AIGUILLE SUTURE PASSE FILS OBWEGESER 140 MM MAXILLO FACIAL
A030071 *OBWEGESER SUTURE NEEDLE FORCEPS 140 MM MAXILLARY*



AIGUILLE SUTURE PASSE FILS OBWEGESER 180 MM
MAXILLO FACIAL

A030072 *OBWEGESER SUTURE NEEDLE FORCEPS
180 MM MAXILLARY*



AIGUILLE SUTURE PASSE FILS SANDERS BROWN
290 MM MAXILLO FACIAL

A030074 SANDERS BROWN SUTURE NEEDLE
FORCEPS 290 MM MAXILLARY



AIGUILLE SUTURE PASSE FILS OBWEGESER
230 MM MAXILLO FACIAL

A030073 OBWEGESER SUTURE NEEDLE FORCEPS
230 MM MAXILLARY



AIGUILLE SUTURE PASSE FILS
SANDERS BROWN
300 MM MAXILLO FACIAL

A030075 SANDERS BROWN SUTURE
NEEDLE FORCEPS 300 MM
MAXILLARY



ALENE REDON CH 7 COURBE

A040076 ALENE REDON CH 7 CURVED

ALENE REDON CH 7 DROITE

A040085 ALENE REDON CH 7 STRAIGHT



COURBE
CURVED

CHARRIERE
CHARRIERE

DIAMETRE
DIAMETER

DROITE
STRAIGHT

A040094

6

2,00 MM

A040095

A040076

7

2,33 MM

A040085

A040077

8

2,66 MM

A040086

A040078

9

3,00 MM

A040087

A040079

10

3,33 MM

A040088

A040080

12

4,00 MM

A040089

A040081

14

4,66 MM

A040090

A040082

15

5,00 MM

A040091

A040083

16

5,33 MM

A040092

A040084

18

6,00 MM

A040093

REAMER

ALESOIR 6 MM EN T

A050095 REAMER 6 MM T FORME



A050096
7 MM

A050097
8 MM

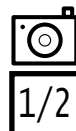

ALESOIR 11 MM FLEXIBLE A BAGUE
A050101 REAMER 11 MM FLEXIBLE WITH RING

DIAMETRE
 DIAMETER

A050098

9 MM

A050099

9,5 MM

A050116

10 MM

A050100

10,5 MM

A050101

11 MM

A050102

11,5 MM

A050103

12 MM

A050104

12,5 MM

A050105

13 MM

A050106

13,5 MM

A050107

14 MM

A050108

14,5 MM

A050109

15 MM

A050110

15,5 MM

A050111

16 MM

A050112

16,5 MM

A050113

17 MM

A050114

17,5 MM

A050115

18 MM

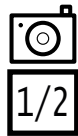

AMYGDALOTOME

AMYGDALOTOME

www.in-surg.fr

A

MANCHE POUR AMYGDALOTOME SLUDER BALLENGER
A080127 HANDLE FOR SLUDER BALLENGER TONSILLECTOMES

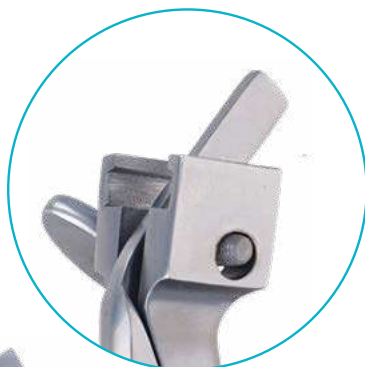

AMYGDALOTOME SLUDER
BALLENGER LAME N°1
SEULE

A080124 *SLUDER BALLENGER
TONSILLECTOMES BLADE
N°1 THE PIECE*



AMYGDALOTOME SLUDER
BALLENGER LAME N° 2
SEULE

A080125 *SLUDER BALLENGER
TONSILLECTOMES BLADE
N°2 THE PIECE*



AMYGDALOTOME SLUDER
BALLENGER LAME N° 3
SEULE

A080126 *SLUDER BALLENGER
TONSILLECTOMES BLADE
N°3 THE PIECE*





ANNEAUX ENDARTERIECTOMIE VOLLMAR Ø 2 - 550MM

A090128 VOLLMAR ENDARTERIECTOMY RING 2 X 550 MM

A090129
Ø 3 - 550 MM



A090130
Ø 4 - 550 MM

A090131
Ø 6 - 550 MM

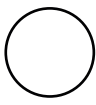

A090132
Ø 7 - 550 MM

A090133
Ø 8 - 550 MM

A090134
Ø 10 - 550 MM

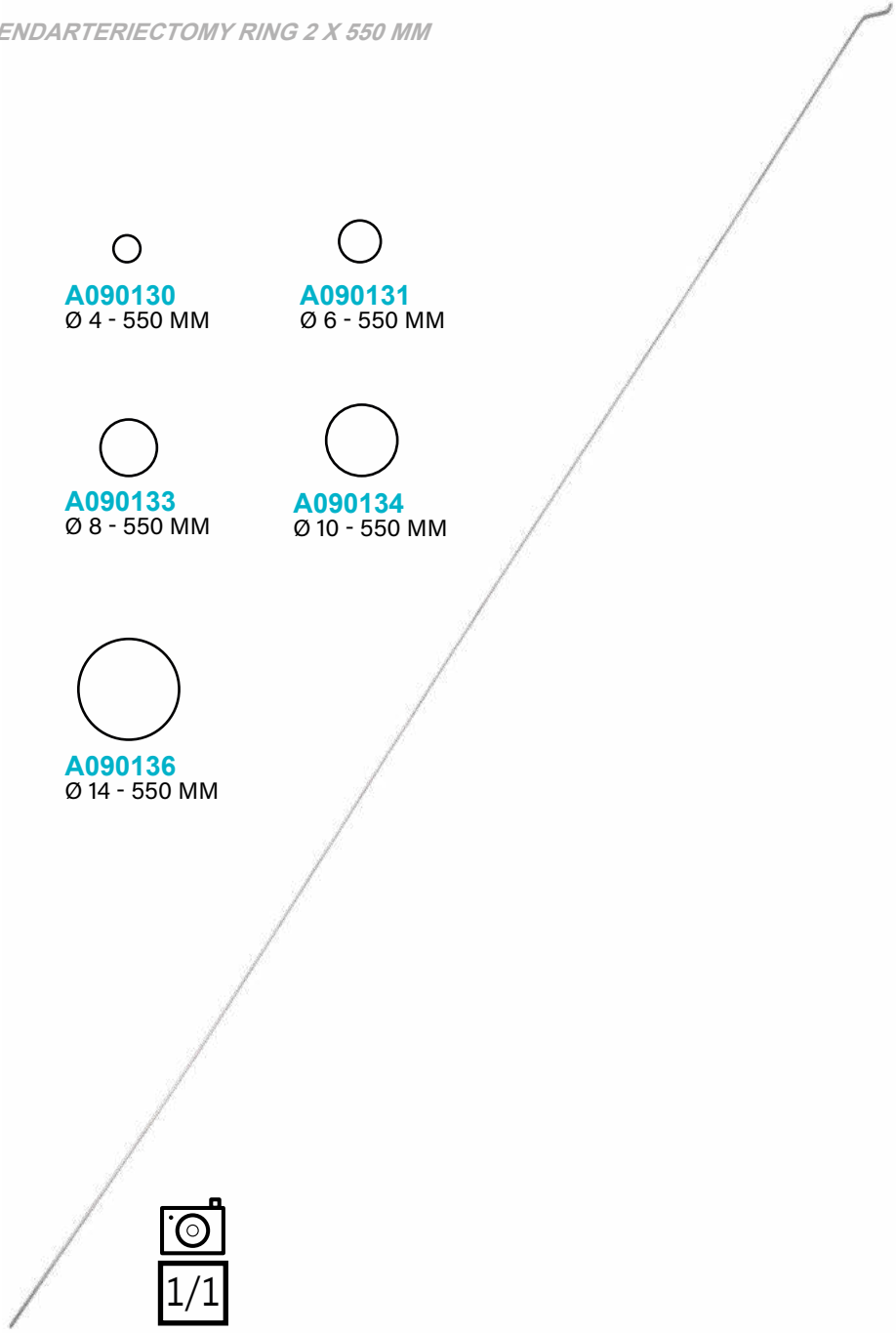

A090135
Ø 12 - 550 MM

A090136
Ø 14 - 550 MM

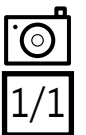

MANCHE POUR ANNEAUX ENDARTERIECTOMIE VOLLMAR

A090137 HANDLE FOR VOLLMAR ENDARTERIECTOMY RINGS



LOOP

ANSE AURICULAIRE BILLAU 3 X 160 MM

A100138 *BILLAU LOOP ATRIAL 3 X 160 MM*



A100139
4 X 160 MM

A100140
4,5 X 160 MM

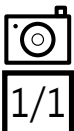

ANSE AURICULAIRE SNELLEN 130 MM

A100141 *SNELLEN LOOP ATRIAL 130 MM*

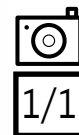

ANUSCOPE BENSAUDE ADULTE
A110142 *BENSAUDE ANUSCOPE ADULT*



**Garantie
totale
5 ANS
sans conditions**



ANUSCOPE FANSLER 22 X 95 MM

A110144 FANSLER ANUSCOPE 22 X 95 MM

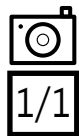

ANUSCOPE SIMS 150 MM AJOURE

A110145 SIMS OPENWORK ANUSCOPE 150 MM

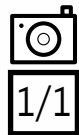

SOMMAIRE

BISTOURI	45
<i>SCALPEL</i>	
BOUGIE	52
<i>BOUGIE</i>	



B

RETRO 'SPECTIVE

Claude BERNARD
(12 juillet 1813 - 10 février 1878)

était un **médecin, physiologiste et épistémologue** français. Dès 1850, il met en lumière **l'homéostasie**, un an plus tard, il **découvre le rôle de la sécrétion pancréatique** ainsi que l'augmentation de la température cutanée après section du nerf sympathique cervical.

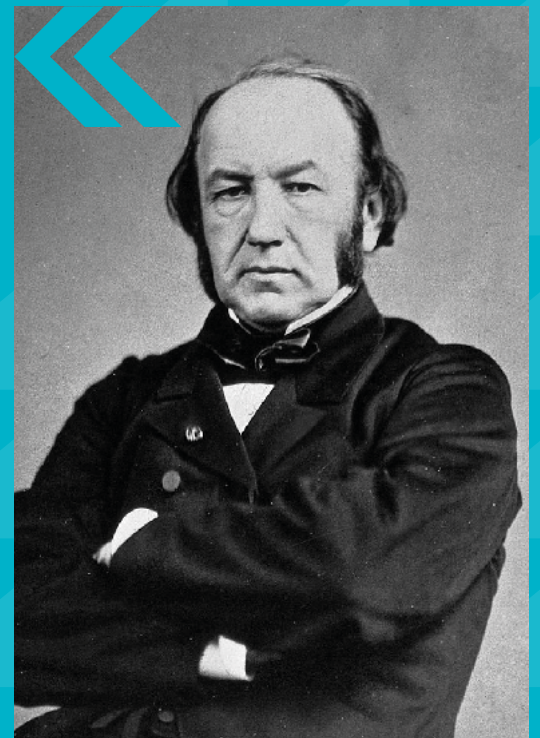

BISTOURI
*SCALPEL***BISTOURI CASPAR 180 MM DROIT MANCHE ROND****B010150** *CASPAR SCALPEL 180 MM STRAIGHT
ROUND HANDLE***BISTOURI ADSON 200 MM CROCHET
COUDE 90°****B010152** *ADSON SCALPEL 200 MM HOOK
FORME ANGLED 90°*

BISTOURI HALLE 200 MM DROIT PR DURE MERE
B010155 HALLE DURA SCALPEL STRAIGHT 200 MM

BISTOURI HARDY 241 MM BAÏONNETTE
B010156 HARDY SCALPEL 241 MM BAYONET FORM

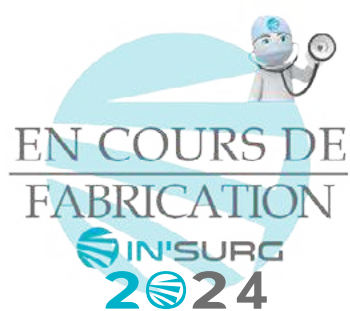

BISTOURI

SCALPEL

BISTOURI 45 MM CONVEXE

B010153 SCALPEL CONVEX 45 MM

BISTOURI 50 MM DROIT

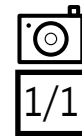
B010154 SCALPEL STRAIGHT 50 MM

BISTOURI MANCHE N°3 LONG ANGLE POUR LAMES FIGURE 10-11-12-12d-13-15

B010160 HANDLE SCALPEL N°3L FLAT ANGLED FOR BLADES FIG 10-11-12-12d-13-15



BISTOURI MANCHE N°3 LONG POUR LAMES FIGURE 10-11-12-12d-13-15

B010161 HANDLE SCALPEL N°3L FOR BLADES FIG 10-11-12-12d-13-15

BISTOURI MANCHE N°3 POUR LAMES FIGURE 10-11-12-12d-13-15

B010162 HANDLE SCALPEL N°3 FOR BLADES FIG 10-11-12-12d-13-15

BISTOURI MANCHE N°3 ROND POUR LAMES FIGURE 10-11-12-12d-13-15

B010163 HANDLE SCALPEL N°3 ROUND HANDLE FOR BLADES FIG 10-11-12-12d-13-16

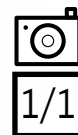
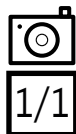
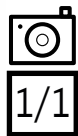

BISTOURI

SCALPEL

BISTOURI MANCHE N°4 LONG ANGLE POUR LAMES
FIGURE 18-19-20-21-22-23-24-25-36

B010167 HANDLE SCALPEL N°4L FLAT ANGLED FOR BLADES
FIG 18-19-20-21-22-23-24-25-36

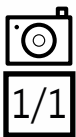

BISTOURI MANCHE N°4 LONG POUR LAMES
FIGURE 18-19-20-21-22-23-24-25-36

B010169 HANDLE SCALPEL N°4L FOR BLADES
FIG 18-19-20-21-22-23-24-25-36

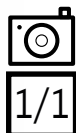

BISTOURI MANCHE N°4 POUR LAMES
FIGURE 18-19-20-21-22-23-24-25-36

B010170 HANDLE SCALPEL N°4 FOR BLADES
FIG 18-19-20-21-22-23-24-25-36

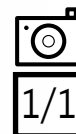

BISTOURI MANCHE N°5 OU N°7 POUR LAMES
FIGURE 10-11-12-12d-13-15

B010171 HANDLE SCALPEL N°5 FOR BLADES
FIG 10-11-12-12d-13-15



BISTOURI TYPE BEAVER 130 MM POUR LAMES
FIGURE 61-62-64-65-67-69

B010172 BEAVER TYPE SCALPEL 130 MM FOR
BLADES FIG 61-62-64-65-67-69



B010173
150 MM

B010174
200 MM

BISTOURI

SCALPEL

BISTOURI SIMS 220 MM DROIT
B010177 SIMS SCALPEL 220 MM STRAIGHT



DROIT
 STRAIGHT
B010177



COUDEE A DROITE
 RIGHT ANGLED
B010175



COUDEE A GAUCHE
 LEFT ANGLED
B010176

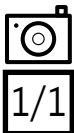

BISTOURI TOENNIS 140 MM
B010178 TOENNIS SCALPEL 140 MM



B010179
 200 MM



BRISE LAME 120 MM
B030326 BLADE BREAKER 120 MM

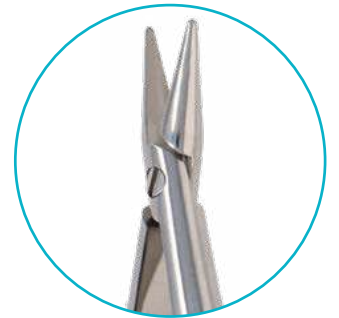

BOUGIE

BOUGIE

BOUGIE DITTEL CH 10 COURBE

B020180 DITTEL URETHRAL BOUGIE CH 10 CURVED

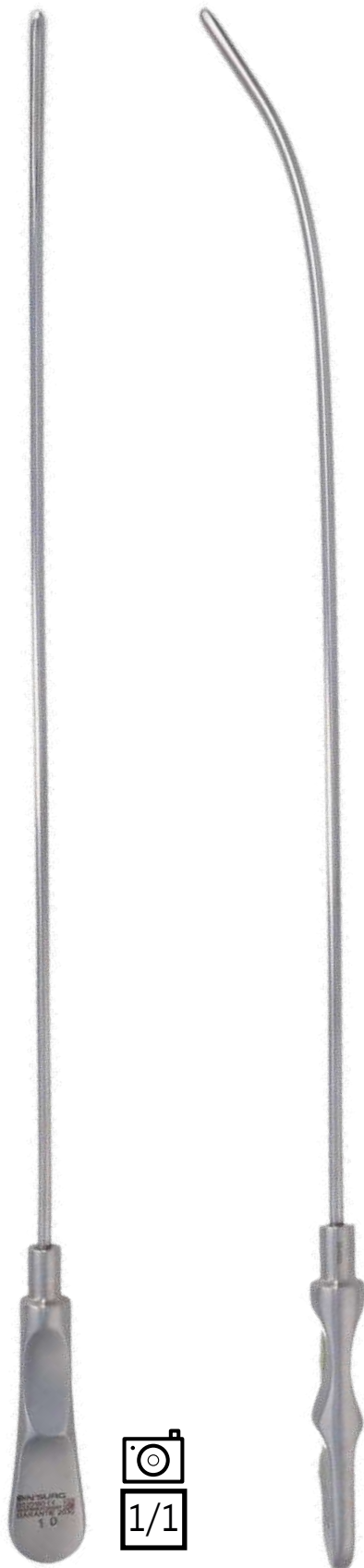

CHARRIERE
CHARRIERE

DIAMETRE
DIAMETER

B020201	8	2,66 MM
B020202	9	3,00 MM
B020180	10	3,33 MM
B020181	11	3,66 MM
B020182	12	4,00 MM
B020183	13	4,33 MM
B020184	14	4,66 MM
B020185	15	5,00 MM
B020186	16	5,33 MM
B020187	17	5,66 MM
B020188	18	6,00 MM
B020189	19	6,33 MM
B020190	20	6,66 MM
B020191	21	7,00 MM
B020192	22	7,33 MM
B020193	23	7,66 MM
B020194	24	8,00 MM
B020195	25	8,33 MM
B020196	26	8,66 MM
B020197	27	9,00 MM
B020198	28	9,33 MM
B020199	29	9,66 MM
B020200	30	10,00 MM

BOUGIE DITTEL CH 10 DROITE

B020203 DITTEL URETHRAL BOUGIE CH 10 STRAIGHT



B020225

B020226

B020203

B020204

B020205

B020206

B020207

B020208

B020209

B020210

B020211

B020212

B020213

B020214

B020215

B020216

B020217

B020218

B020219

B020220

B020221

B020222

B020223

B020224

CHARRIERE
CHARRIERE

DIAMETRE
DIAMETER

8

2,66 MM

9

3,00 MM

10

3,33 MM

11

3,66 MM

12

4,00 MM

13

4,33 MM

14

4,66 MM

15

5,00 MM

16

5,33 MM

17

5,66 MM

18

6,00 MM

19

6,33 MM

20

6,66 MM

21

7,00 MM

22

7,33 MM

23

7,66 MM

24

8,00 MM

25

8,33 MM

26

8,66 MM

27

9,00 MM

28

9,33 MM

29

9,66 MM

30

10,00 MM

32

10,66 MM

BOUGIES GUYON BENIQUE SERIE CH 10 À CH 30 SANS FILET

B020227 GUYON BENIQUE BOUGIE SERIES TO CH 10 AT CH 30 WITHOUT THREADED



Une solution parfaite
pour le classement par
taille de vos bougies

BOUGIE

BOUGIE

BOUGIE HANK JEU DE 6

B020228 HANK BOUGIE SET OF 6 PIECES

BOUGIE HAWKIN AMBLER 7 - 10 MM

B020232 HAWKIN AMBLER URETHRAL BOUGIE 7-10MM

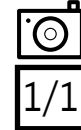

DIAMETRE
DIAMETER

B020229	4 - 7 MM
B020230	5 - 8 MM
B020231	6 - 9 MM
B020233	8 - 11 MM
B020234	9 - 12 MM
B020235	10 - 13 MM
B020236	11 - 14 MM

BOUGIE HEGAR 3 MM SIMPLE

B020241 HEGAR URETHRAL BOUGIE 3 MM SINGLE

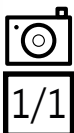

	DIAMETRE DIAMETER		DIAMETRE DIAMETER		DIAMETRE DIAMETER
B020237	1,00 MM	B020262	13,50 MM	B020273	21,00 MM
B020238	1,50 MM	B020263	14,00 MM	B020274	22,00 MM
B020239	2,00 MM	B020264	14,50 MM	B020275	23,00 MM
B020240	2,50 MM	B020265	15,00 MM	B020276	24,00 MM
B020242	3,50 MM	B020266	15,50 MM	B020277	25,00 MM
B020243	4,00 MM	B020267	16,00 MM	B020278	26,00 MM
B020244	4,50 MM	B020268	16,50 MM	B020279	27,00 MM
B020245	5,00 MM	B020269	17,00 MM	B020280	28,00 MM
B020246	5,50 MM	B020270	18,00 MM	B020281	29,00 MM
B020247	6,00 MM	B020271	19,00 MM	B020282	30,00 MM
B020248	6,50 MM	B020272	20,00 MM		
B020249	7,00 MM				
B020250	7,50 MM				
B020251	8,00 MM				
B020252	8,50 MM				
B020253	9,00 MM				
B020254	9,50 MM				
B020255	10,00 MM				
B020256	10,50 MM				
B020257	11,00 MM				
B020258	11,50 MM				
B020259	12,00 MM				
B020260	12,50 MM				
B020261	13,00 MM				

B020324

**BOUGIE HEGAR SIMPLE
SERIE EN BOITE N°1 A 26**

*HEGAR URETHRAL SINGLE BOUGIE
SET IN THE BOX TO N°1 AT N°26*

B020325
N°4 A N°17

BOUGIE HEGAR N°11 SUR MANCHE

B020293 HEGAR URETHRAL BOUGIE N°11 ON THE MANCHE



B020283

B020284

B020285

B020286

B020287

B020288

B020289

B020290

B020291

B020292

B020293

B020294

B020295

DIAMETRE
DIAMETER

N°1

N°2

N°3

N°4

N°5

N°6

N°7

N°8

N°9

N°10

N°11

N°12

N°13

B020296

B020297

B020298

B020299

B020300

B020301

B020302

B020303

B020304

B020305

B020306

B020307

B020308

DIAMETRE
DIAMETER

N°14

N°15

N°16

N°17

N°18

N°19

N°20

N°21

N°22

N°23

N°24

N°25

N°26

BOUGIE HEGAR 3 X 4 MM DOUBLE

B020310 HEGAR URETHRAL BOUGIE 3 X 4 MM DOUBLE

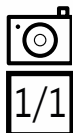

DIAMETRE
DIAMETER

B020309	1 X 2 MM
B020311	5 X 6 MM
B020312	7 X 8 MM
B020313	9 X 10 MM
B020314	11 X 12 MM
B020315	13 X 14 MM
B020316	15 X 16 MM
B020317	17 X 18 MM
B020318	19 X 20 MM
B020319	21 X 22 MM
B020320	23 X 24 MM
B020321	25 X 26 MM



B020322

**BOUGIE HEGAR DOUBLE
SERIE EN BOITE N°1-2 A
25-26**

*HEGAR URETHRAL DOUBLE BOUGIE
SET IN THE BOX TO N°1-2 AT N°25-26*

B020323

N°3-4 A N°17-18

CADRE EPINGLE PORTE PINCES	61	BRONCHES	288
<i>INSTRUMENTS HOLDER FRAME</i>		<i>BRONCHIAL VASCULAR CLAMP</i>	
CANULE	63	BULLDOG (A CREMAILLE)	291
<i>CANNULA</i>		<i>BULLDOG VASCULAR CLAMP (WITH RATCHET)</i>	
CHASSE GREFFONS	72	CAROTIDES	293
<i>TAMPERS GRAFT</i>		<i>CAROTID VASCULAR CLAMP</i>	
CHAUSSE - VEINE	76	COARCTATION	295
<i>VEIN INSERTER</i>		<i>COARCTATION VASCULAR CLAMP</i>	
CISAILLE	77	ILIAQUE	303
<i>SHEAR</i>		<i>ILIAC VASCULAR CLAMP</i>	
CINTREUSE	82	LIGATURE DISSECTION	304
<i>BENDER</i>		<i>LIGATURE DISSECTION VASCULAR CLAMP</i>	
CISEAU A OS :		MULTIPOSE	305
BURIN	83	<i>MULTIPOSE VASCULAR CLAMP</i>	
<i>BONE CHISEL</i>		OCCLUSION TANGENTIELLE	309
GOUGE	99	<i>TANGENTIAL OCCLUSION VASCULAR CLAMP</i>	
<i>BONE GOUGE</i>		PEDIATRIQUE	311
OSTEOTOME	121	<i>PEDIATRIC VASCULAR CLAMP</i>	
<i>BONE OSTEOTOME</i>		PERIPHERIQUE	315
CISEAUX :		<i>VASCULAR CLAMP PERIPHERAL</i>	
CAPSULAIRE	134	RENAL	323
<i>CAPSULAR SCISSORS</i>		<i>RENAL VASCULAR CLAMP</i>	
COURANTS	136	CLE CAMBRAGE / PLATE	324
<i>SCISSORS</i>		<i>CAMBER / FLAT KEY</i>	
DISSECTEURS	160	CLIPS (PINCE À POSER)	325
<i>DISSECTING SCISSORS</i>		<i>CLIPS (FORCEPS FOR PLACING)</i>	
ENTEROTOMES	184	COMPRESSEUR	326
<i>ENTEROTOMY SCISSORS</i>		<i>COMPRESSOR</i>	
FILS	185	COSTOTOME	327
<i>WIRE SCISSORS</i>		<i>RIB SHEAR</i>	
GYNECO	187	COUTEAU :	
<i>GYNECO SCISSORS</i>		AMPUTATION	333
MICRO	197	<i>AMPUTATION KNIFE</i>	
<i>MICRO SCISSORS</i>		MENISQUE	334
NEURO	202	<i>MENISCUS KNIFE</i>	
<i>NEURO SCISSORS</i>		NEURO	335
O.R.L	204	<i>NEURO KNIFE</i>	
<i>E.N.T SCISSORS</i>		O.R.L	339
ONGLES	227	<i>E.N.T KNIFE</i>	
<i>NAILS SCISSORS</i>		PLATRE	345
PANSEMENT	228	<i>PLASTER KNIFE</i>	
<i>BANDAGE SCISSORS</i>		CROCHET	346
RECTUM	232	<i>HOOK</i>	
<i>RECTUM SCISSORS</i>		CUPULE	374
VASCULAIRE	233	<i>CUP</i>	
<i>VASCULAR SCISSORS</i>		CURETTE :	
CLAMP BAR	242	CALCULS BILIAIRES	375
<i>CLAMP STEEL</i>		<i>GALLSTONE CURETTE</i>	
CLAMP BULLDOG	243	CALCULS RENAUX	378
<i>BULLDOG CLAMP</i>		<i>KIDNEY STONE CURETTE</i>	
CLAMP DIGESTIF	248	DERMATO	379
<i>DIGESTIVE CLAMP</i>		<i>DERMATO CURETTE</i>	
CLAMP VASCULAIRE :		GYNECO	381
ANASTOMOSE	268	<i>GYNECO CURETTE</i>	
<i>ANASTOMOSIS VASCULAR CLAMP</i>		NEURO	395
AORTIQUE	272	<i>NEURO CURETTE</i>	
<i>AORTIC VASCULAR CLAMP</i>		O.R.L	400
AURICULAIRE	287	<i>E.N.T CURETTE</i>	
<i>ATRIAL VASCULAR CLAMP</i>		OSSEUSE	411
		<i>BONE CURETTE</i>	



C

RETRO 'SPECTIVE

Williams Harvey CUSHING
(8 avril 1869 - 7 octobre 1939)

est unanimement considéré comme le **plus grand neurochirurgien du XXe siècle** et le «**père de la neurochirurgie moderne**». Il est le **premier chirurgien américain à opérer une tumeur du cerveau** et a considérablement amélioré la survie des patients.

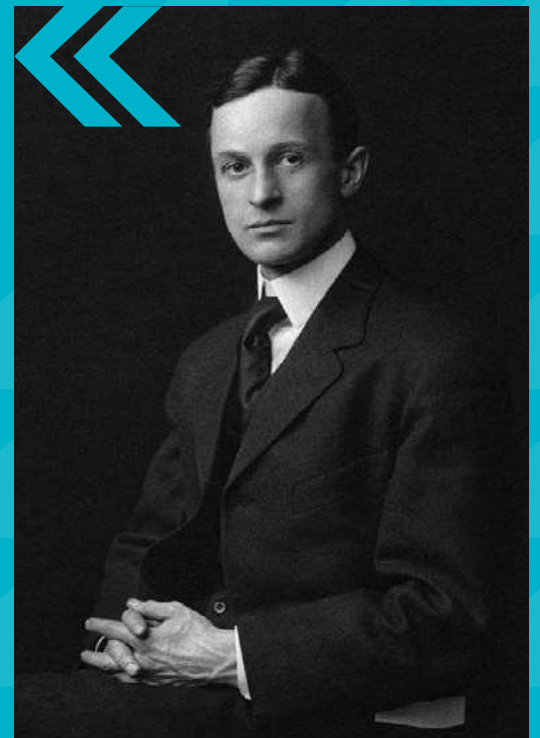



CADRE EPINGLE PORTE PINCES

INSTRUMENTS HOLDER FRAME

EPINGLE PORTE PINCES 150 MM
C010331 SAFETY-PIN FOR FORCEPS 150 MM

EPINGLE PORTE PINCES 150 MM A BOULE
C010332 SAFETY-PIN FOR FORCEPS 150 MM WITH BALL



C010333
200 MM

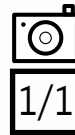
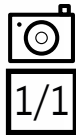

CADRE PORTE INSTRUMENT LORTAT JACOB PLIANT
C010334 LORTAT JACOB FOLDING INSTRUMENTS HOLDER FRAME

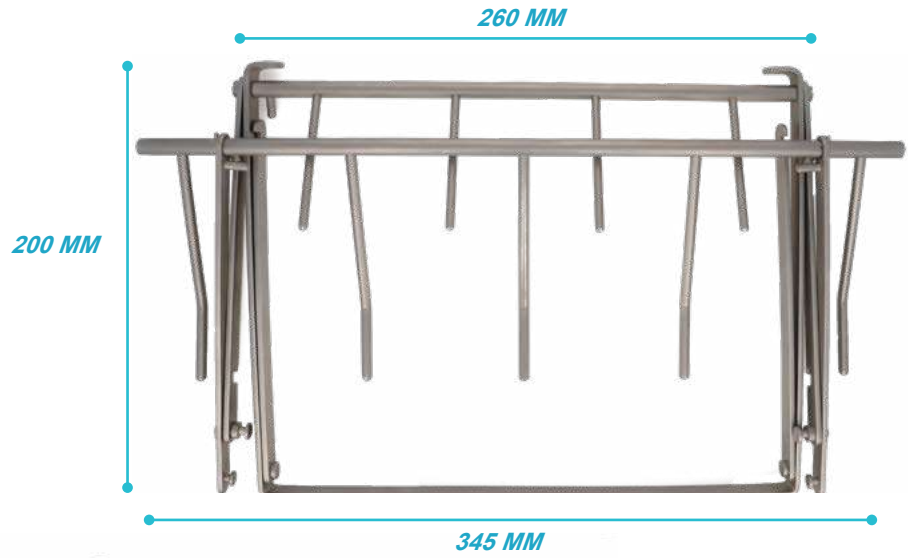

CANULE

CANNULA

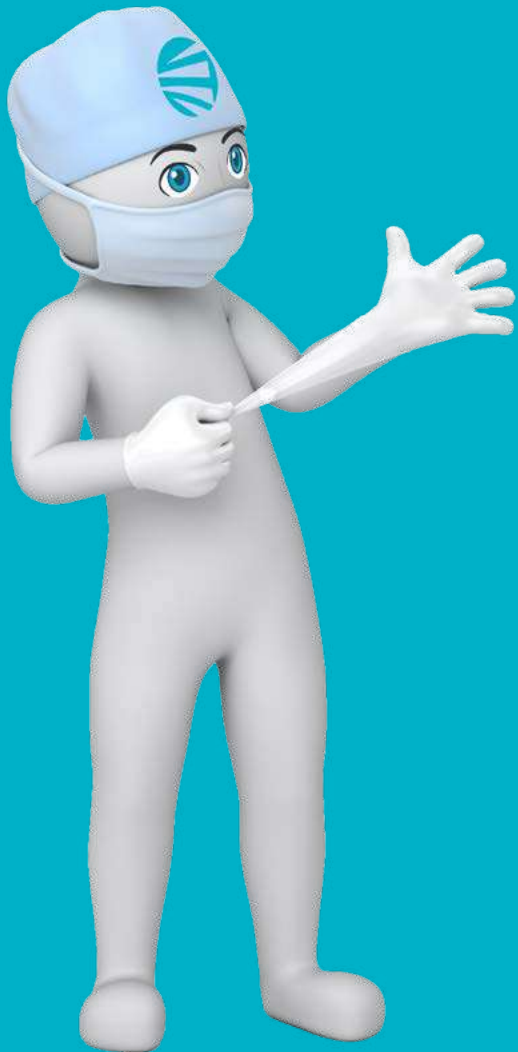

CANULE ASPIRATION ADSON 4 X 210 MM DROITE

C020337 ADSON SUCTION CANNULA 4 X 210 MM STRAIGHT

C020336
COURBE
CURVED

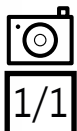

CANULE ASPIRATION AUBERT 10 X 355 MM INOX

C020338 AUBERT SUCTION CANNULA 10 X 355 MM STAINLESS STEEL



CANULE ASPIRATION DEBAKEY 8 X 290 MM

C020340 DEBAKEY SUCTION CANNULA 8 X 290 MM



CANULE

CANNULA

CANULE ASPIRATION FRAZIER 2,6 X 125 MM
COUDEE

C020341 FRAZIER SUCTION CANNULA 2,6 X 125 MM
ANGLED

CANULE ASPIRATION FRAZIER 2,6 X 125 MM
DROITE

C020349 FRAZIER SUCTION CANNULA 2,6 X 125 MM
STRAIGHT

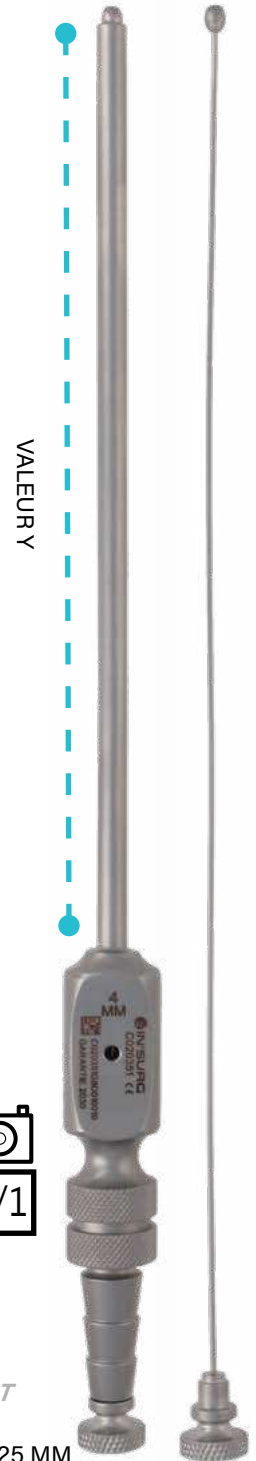
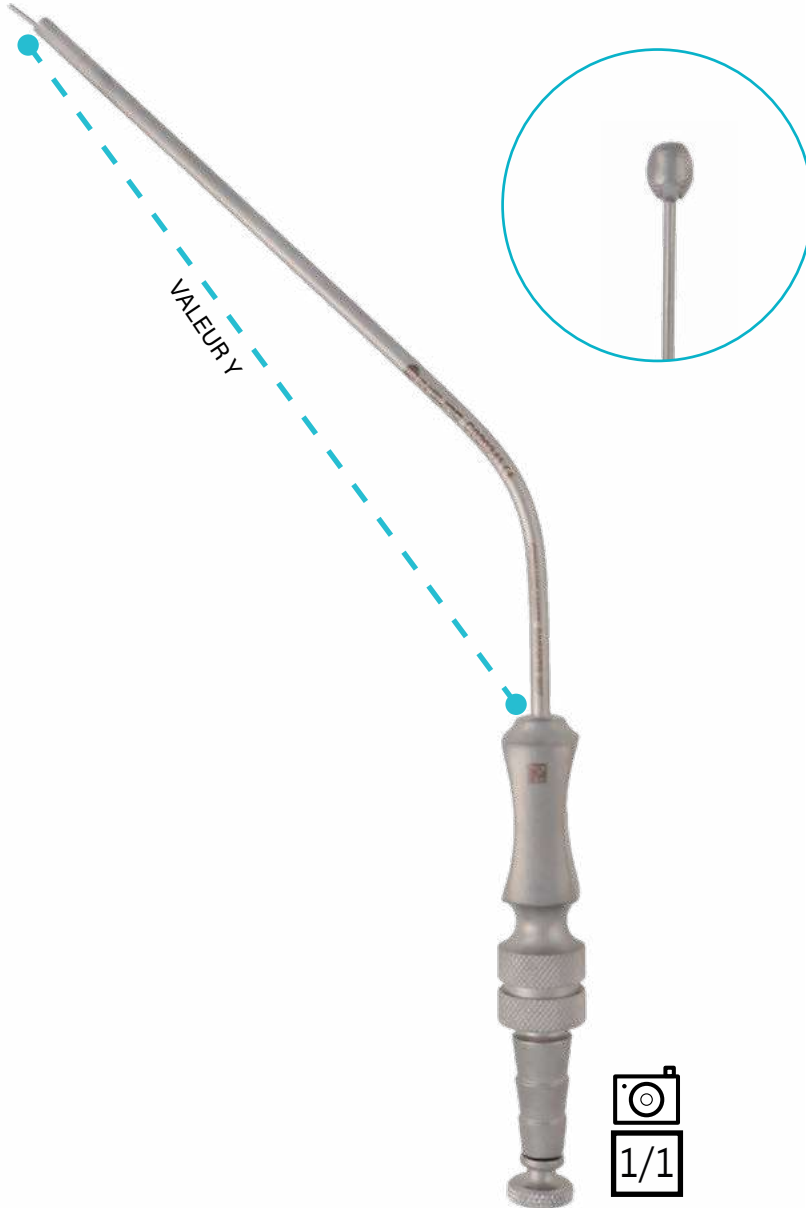

COUDEE
ANGLED

DROITE
STRAIGHT

DIAMETRE DIAMETER	Y = 125 MM Y = 180 MM Y = 200 MM		
	2,6 MM	C020341	C020345
3,3 MM	C020342	C020346	
4 MM	C020343	C020347	
5 MM	C020344		C020348

DIAMETRE DIAMETER	Y = 125 MM
	2,6 MM
3,3 MM	C020350
4 MM	C020351

CANULE ASPIRATION POOLE 8 X 220 MM
COURBE

C020353 POOLE SUCTION CANNULA 8 X 220 MM
CURVED

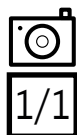

CANULE ASPIRATION POOLE 10 x 220 MM

C020354 POOLE SUCTION CANNULA
10 X 220 MM

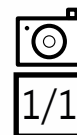

C020352
5 X 205 MM



CANULE

CANNULA

CANULE ASPIRATION POOLE
10 x 260 MM REGLABLE

C020355 POOLE SUCTION CANNULA
10 X 260 MM ADJUSTABLE

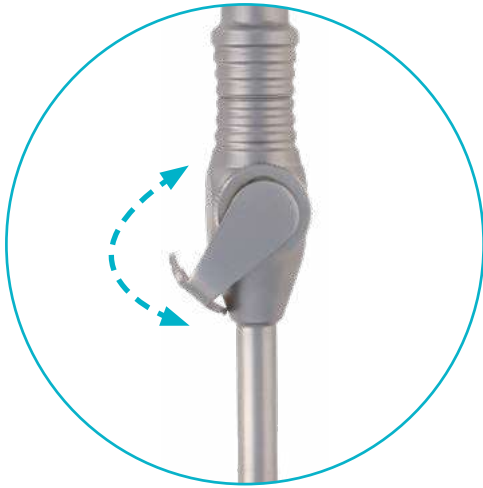

**CANULE ASPIRATION SANTY 2.5 X 280 MM
EMBOUT 3 MM**

C020356 *SANTY SUCTION CANNULA 2,5 X 280 MM
TIP 3 MM*



CANULE ASPIRATION YANKAUER 10 x 320 MM

C020376 *YANKAUER SUCTION CANNULA 10 X 320 MM*



C020357
2.5 X 280 MM - EMBOUT 4 MM
TIP 4 MM

C020358
4 X 280 MM - EMBOUT 4,5 MM
TIP 4,5 MM

C020359
4 X 280 MM - EMBOUT 7 MM
TIP 7 MM

C020360
5 X 280 MM - EMBOUT 9 MM
TIP 9 MM

C020361
8 X 280 MM - EMBOUT 13 MM
TIP 13 MM

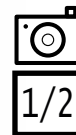
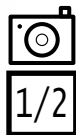
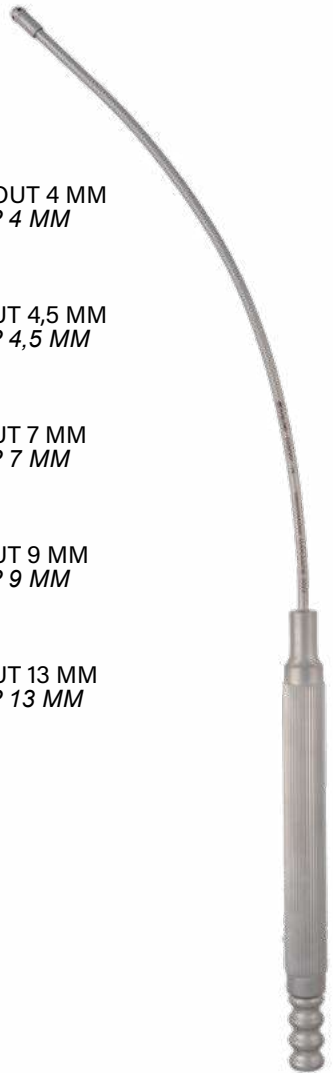

CANULE

CANNULA

CANULE ASPIRATION WERTHEIMER 5 X 170 MM
RIGIDE COUDEE

C020373 WERTHEIMER SUCTION CANNULA 5 X 170 MM
ANGLED RIGIDE

CANULE ASPIRATION WERTHEIMER
2 X 250 MM MALLEABLE

C020363 WERTHEIMER SUCTION
CANNULA 2 X 250 MM
MALLEABLE



C020369
1 X 170 MM

C020370
2 X 170 MM

C020371
3 X 170 MM

C020372
4 X 170 MM

C020374
6 X 170 MM

C020375
7 X 170 MM



C020362
1 X 250 MM

C020364
3 X 250 MM

C020365
4 X 250 MM

C020366
5 X 250 MM

C020367
6 X 250 MM

C020368
7 X 250 MM



**CANULE BIOPSIE NOVAK 2 X 230 MM
ENDO-UTERINE**

C020377 *NOVAK BIOPSY CANNULA 2 X 230 MM
ENDO-UTERINE*

**CANULE BIOPSIE RANDALL 4 X 240 MM
ENDO-UTERINE**

C020380 *RANDALL BIOPSY CANNULA 4 X 240 MM
ENDO-UTERINE*



C020378
3 X 230 MM

C020379
4 X 230 MM

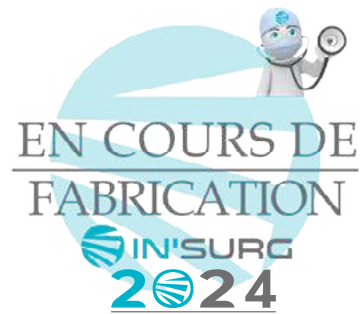

CANULE HEPARINE DIAM 2.5 MM EMBOUT DIAM 4 MM FIGURE 1
C020385 *HEPARINE CANNULA DIAM 2.5 MM NOZZLE DIAM 4 MM FIGURE 1*



C020386
FIGURE 2
FIGURE 2

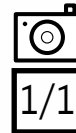

C020387
FIGURE 3
FIGURE 3

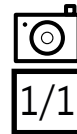

CANULE HEPARINE DIAM 1.5 MM EMBOUT DIAM 2 MM DELICATE
C020383 *HEPARINE CANNULA DIAM 1.5 MM NOZZLE DIAM 2 MM DELICATE*

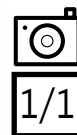

CANULE HEPARINE DIAM 1.5 MM EMBOUT DIAM 2 MM DELICATE FIG GLOVER
C020384 *HEPARINE CANNULA DIAM 1.5 MM NOZZLE DIAM 2 MM DELICATE GLOVER FIGURE*

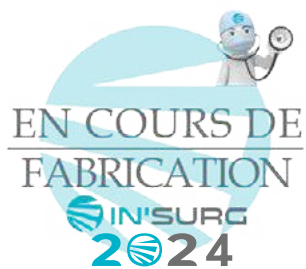

CHASSE GREFFONS

www.in-surg.fr



TAMPERS GRAFT

CHASSE GREFFONS
CASPAR 8 X 200 MM
MANCHE SYNTHETIQUE

C030404 CASPAR TAMPERS
GRAFT 8 X 200 MM
SYNTHETIQUE HANDLE

CHASSE GREFFONS
CYLINDRIQUE
5 X 160 MM

C030407 CYLINDRIQUE
TAMPERS GRAFT
5 X 160 MM

CHASSE GREFFONS
CYLINDRIQUE 8 X 160 MM
AV EMBOUT PLASTIQUE

C030410 CYLINDRIQUE
TAMPERS GRAFT
8 X 160 MM WITH
PLASTIC NOZZLE



C030401
12 X 200 MM

C030402
3 X 200 MM

C030403
5 X 200 MM



C030405
3 X 160 MM

C030406
4 X 160 MM

C030408
6 X 160 MM

C030409
8 X 160 MM

C030411
10 X 160 MM

C030412
8 X 180 MM



CHASSE GREFFONS

TAMPERS GRAFT

CHASSE GREFFONS CYLINDRIQUE
6 - 8 X 210 MM DOUBLE

C030414 *DOUBLE CYLINDRIQUE TAMPERS
GRAFT 6 - 8 X 210 MM*



C030413
8 - 15 X 160 MM

C030415
10 - 12 X 210 MM

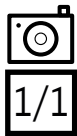

CHASSE GREFFONS CYLINDRIQUE
12 X 220 MM MANCHE CELERON

C030417 *CYLINDRIQUE TAMPERS GRAFT
12 X 220 MM CELERON HANDLE*

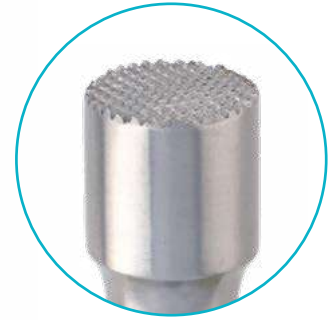

C030418
14 X 220 MM

C030419
16 X 220 MM

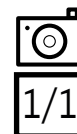

CHASSE GREFFONS RECTANGULAIRE
DEMOISELLE 5 X 8 X 180 MM

C030416 *DEMOISELLE RECTANGULAR
TAMPERS GRAFT 5 X 8 X 180 MM*



CHASSE GREFFONS RECTANGULAIRE
6 X 13 X 180 MM

C030420 *RECTANGULAR TAMPERS GRAFT
6 X 13 X 180 MM*



C030421
10 X 15 X 180 MM

C030422
11 X 20 X 180 MM

CHASSE GREFFONS

TAMPERS GRAFT

CHASSE GREFFONS CARRE TRILLAT
9 X 9 X 200 MM

C030423 TRILLAT TAMPERS GRAFT
9 X 9 X 200 MM

CHASSE GREFFONS RECTANGULAIRE TRILLAT
9 X 19 X 200 MM

C030425 TRILLAT RECTANGULAR TAMPERS GRAFT
9 X 19 X 200 MM



C030424
9 X 16 X 200 MM

VEIN INSERTER

CHAUSSE VEINE KIENNY 175 MM

C040426 *KIENNY VEIN INSERTER 175 MM*

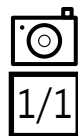

CISAILLE

SHEAR

CISAILLE BANDAGE 200 MM

C050427 *SHEAR FOR BANDAGES 200 MM*



CISAILLE MOURE 200 MM COURBE CRANTEE

C050429 *MOURE SHEAR 200 MM CURVED NOTCHED BLADES*



CISAILLE A PLATRE ESMARCH 200 MM
C050430 ESMARCH SHEAR PLASTER 200 MM

CISAILLE A PLATRE SEUTIN 250 MM EN S COURBE
C050431 SEUTIN SHEAR PLASTER 250 MM
CURVED S FORME

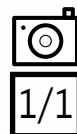



CISAILLE A PLATRE SEUTIN 230 MM DROITE

C050432 SEUTIN SHEAR PLASTER 230 MM STRAIGHT



CISAILLE A PLATRE STILLE 230 MM

C050433 *STILLE SHEAR PLASTER 230 MM*



C050434
260 MM

C050435
370 MM

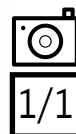

CISAILLE
SHEAR

CISAILLE A PLATRE STILLE 230 MM MODELE FORT
C050436 *STILLE SHEAR PLASTER 230 MM STRONG MODEL*

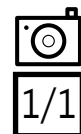

BENDER

CINTREUSE 290 MM 3 POINTS

C060437 BENDER 290 MM 3 POINTS

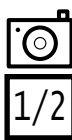

CINTREUSE 200 MM POUR PLAQUES 1,6 MM

C060438 PLATE BENDER 200 MM FOR PLATES 1,6 MM



**CISEAU
A OS
BURIN**

BONE CHISEL

Le Ciseau à Os type Burin est utilisé en chirurgie orthopédique et traumatologique. Il permet de creuser l'os.

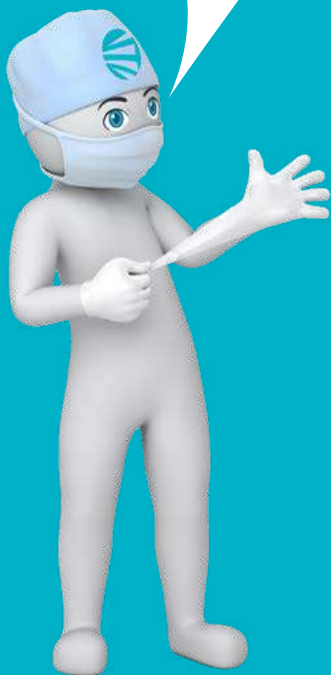

CISEAU A OS BURIN ALEXANDER 4 X 180 MM
C070440 *ALEXANDER BONE CHISEL 4 X 180 MM*

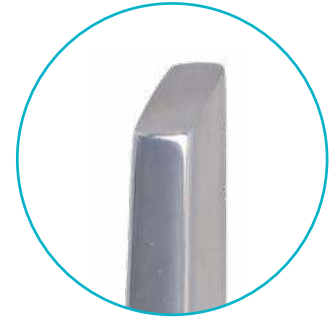

C070441
6 X 180 MM

C070442
8 X 180 MM

C070443
10 X 180 MM

C070444
12 X 180 MM

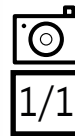

CISEAU A OS BURIN CARROLL 6 X 140 MM

C070445 CAROLL BONE CHISEL 6 X 140 MM



CISEAU A OS BURIN CINELLI 10 X 250 MM

C070446 CINELLI BONE CHISEL 10 X 250 MM



CISEAU A OS BURIN FARABEUF 10 X 210 MM

C070447 FARABEUF BONE CHISEL 10 X 210 MM

LONGUEUR
LENGTHLARGEUR
WIDTH

210 MM

10 MM	C070447
12 MM	C070448
15 MM	C070449
20 MM	C070450
25 MM	C070451
30 MM	C070452

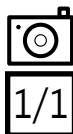

CISEAU A OS BURIN FARABEUF 6 X 250 MM LAME FINE

C070453 FARABEUF BONE CHISEL 6 X 250 MM BENT BLADE

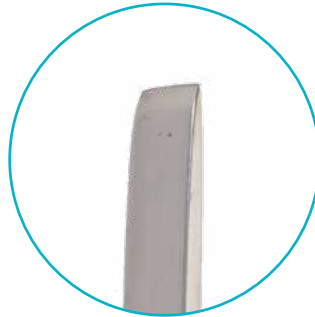

LARGEUR <i>WIDTH</i>	LONGUEUR <i>LENGTH</i>	
	250 MM	300 MM
6 MM	C070453	C070557
8 MM	C070454	C070558
10 MM	C070455	C070456
12 MM	C070457	C070559
15 MM	C070458	C070560
20 MM	C070459	C070561
25 MM	C070460	C070562
30 MM	C070461	C070563

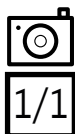

CISEAU A OS BURIN

BONE CHISEL

CISEAU A OS BURIN FREER 4 X 160 MM
COURBE

C070462 *FREER BONE CHISEL 4 X 160 MM
CURVED*

CISEAU A OS BURIN FREER 4 X 160 MM
DROIT

C070463 *BONE CHISEL 4 X 160 MM STRAIGHT*

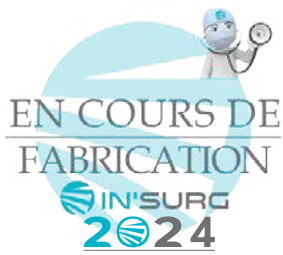

CISEAU A OS BURIN HAUTANT 2 X 130 MM

C070464 HAUTANT BONE CHISEL 2 X 130 MM

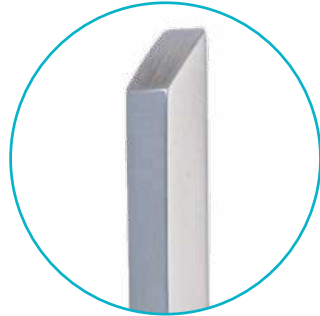

CISEAU A OS BURIN JOST 5 X 205 MM ORL

C070471 JOST ENT BONE CHISEL 5 X 205 MM

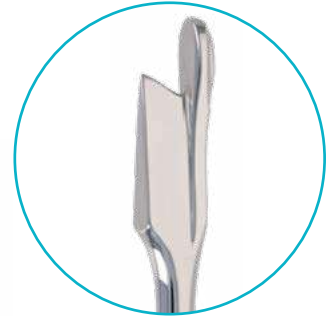

C070465
4 X 130 MM

C070466
5 X 130 MM

C070467
6 X 130 MM

C070468
8 X 130 MM

C070469
10 X 130 MM

C070470
12 X 130 MM

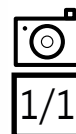
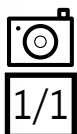

CISEAU A OS BURIN

BONE CHISEL

CISEAU A OS BURIN JUDET
12 X 220 MM COURBE A DECORTIQUER

C070473 JUDET BONE CHISEL
12 X 220 MM CURVED TO DISSECT



C070472
8 X 220 MM

C070474
16 X 220 MM

C070475
18 X 220 MM

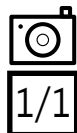

CISEAU A OS BURIN JUDET
10 X 220 MM A DECORTIQUER

C070476 JUDET BONE CHISEL
10 X 220 MM TO DISSECT



C070477
15 X 220 MM

C070478
20 X 220 MM

C070479
25 X 220 MM

C070480
30 X 220 MM

C070481
35 X 220 MM

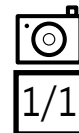

LAME PR CISEAUX A OS BURIN A LAME
INTERCHANGEABLE 5 MM

C070483 *BLADE FOR BONE CHISEL WITH
INTERCHANGEABLE BLADE 5 MM*



C070484
10 MM

C070485
12 MM

C070486
16 MM

C070487
25 MM



1/1

CLE DE SERRAGE PR MANCHE DE CISEAU
A OS BURIN REF C070488

C070482 *WRENCH FOR HANDLE BONE CHISEL
WITH REF C070488*



1/1

MANCHE PR CISEAU A OS BURIN
A LAME INTERCHANGEABLE

C070488 *HANDLE FOR BONE CHISEL WITH
INTERCHANGEABLE BLADE*



1/1



CISEAU A OS BURIN

BONE CHISEL

CISEAU A OS BURIN LEBSCHÉ
245 MM STERNUM

C070489 *LEBSCHÉ BONE CHISEL
245 MM STERNUM*

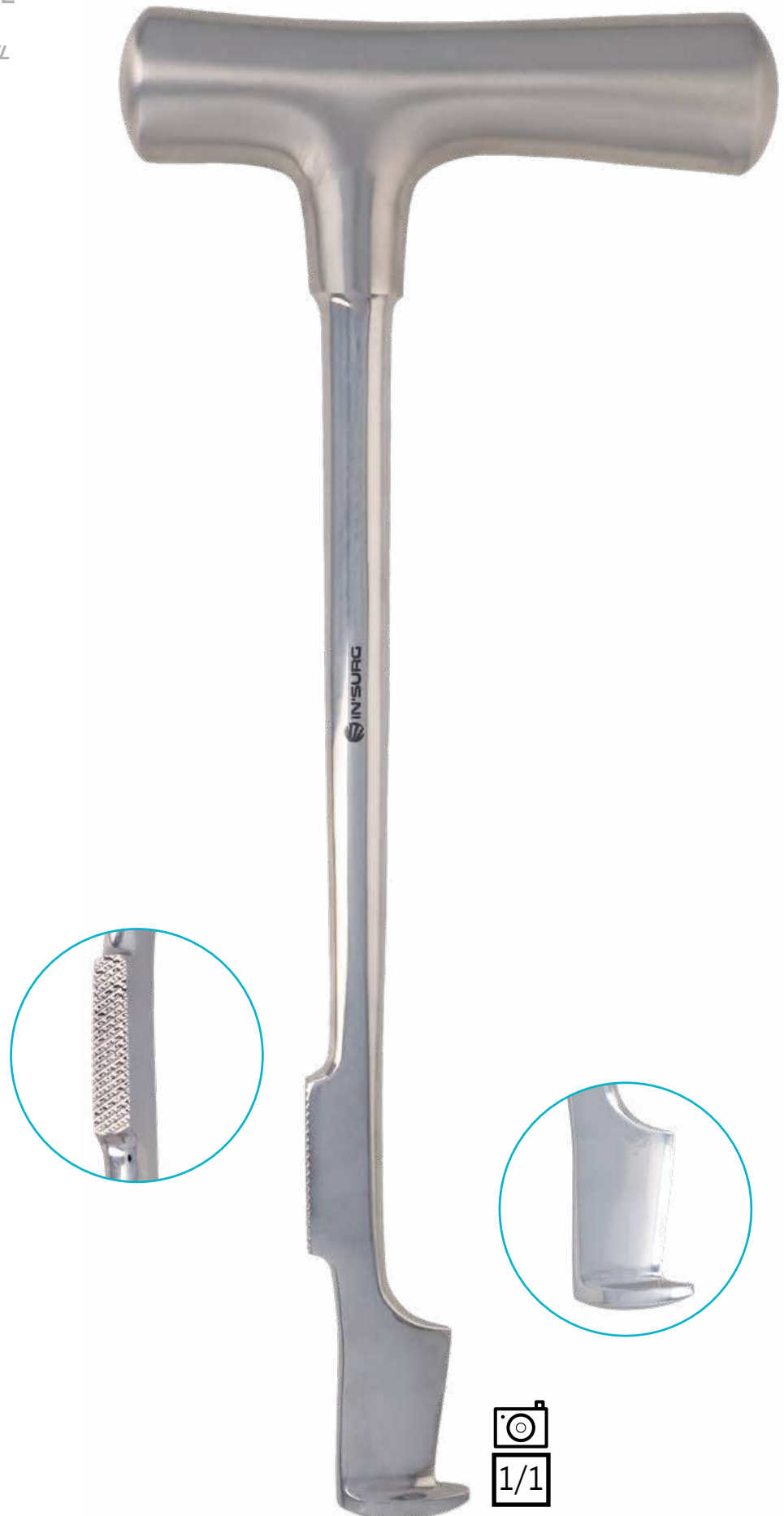

CISEAU A OS BURIN LETOURNEL
6 X 350 MM CIMENT

C070490 *LETOURNEL BONE CHISEL
6 X 350 MM CEMENT*

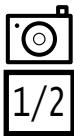

CISEAU A OS BURIN LUCAS CHAMPIONNIERE
35 X 210 MM

C070492 *LUCAS CHAMPIONNIERE BONE CHISEL
35 X 210 MM*

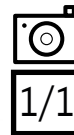

C070491
25 X 210 MM

CISEAU A OS BURIN

BONE CHISEL

CISEAU A OS BURIN MAC EVEN 10 X 200 MM
DROIT GRADUE

C070493 *MAC EVEN BONE CHISEL 10 X 200 MM
STRAIGHT GRADUATED*



C070494
15 X 200 MM

C070495
20 X 200 MM

CISEAU A OS BURIN MANET 3,5 X 130 MM
PEDICURE

C070498 *MANET BONE CHISEL 3,5 X 130 MM
FOR PEDICURE*



CISEAU A OS BURIN OMBREDANNE 15 X 140 MM LAME FINE
C070500 OMBREDANNE BONE CHISEL 15 X 140 MM THIN BLADE

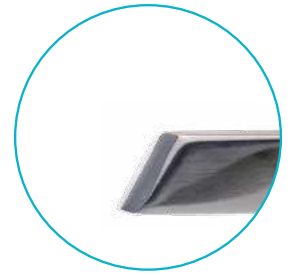

C070499
10 X 140 MM

C070501
20 X 140 MM



CISEAU A OS BURIN PARTSCH 4 X 170 MM
C070507 PARTSCH BONE CHISEL 4 X 170 MM



LONGUEUR
LENGTH

LARGEUR WIDTH	LONGUEUR LENGTH	
	140 MM	170 MM
2 MM	C070502	C070503
3 MM	C070504	C070505
4 MM	C070506	C070507
6 MM	C070508	C070509
8 MM	C070510	C070511

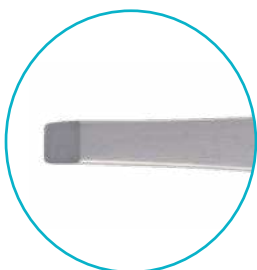



CISEAU A OS BURIN

BONE CHISEL

CISEAU A OS BURIN PAUWELS 5 X 160 MM
C070514 PAUWELS BONE CHISEL 5 X 160 MM

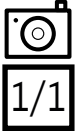
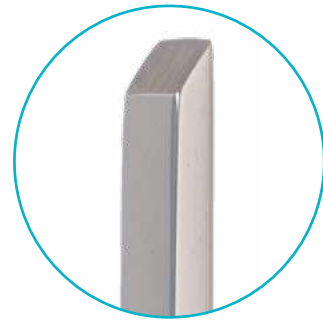

LARGEUR WIDTH	LONGUEUR LENGTH	
	160 MM	240 MM
3 MM	C070512	
4 MM	C070513	
5 MM	C070514	C070515
8 MM	C070516	
9 MM		C070517
10 MM	C070518	C070519
15 MM	C070520	C070521
20 MM	C070522	C070523
25 MM	C070524	C070525
30 MM	C070526	C070527
35 MM	C070528	C070529
40 MM	C070530	C070531
50 MM	C070532	C070533

CISEAU A OS BURIN POIRIER 6 X 160 MM

C070535 POIRIER BONE CHISEL 6 X 160 MM



C070534
4 X 160 MM

C070536
8 X 160 MM

C070537
10 X 160 MM

C070538
12 X 160 MM

C070539
14 X 160 MM



CISEAU A OS BURIN PORTMANN 6 X 160 MM

C070540 PORTMANN BONE CHISEL 6 X 160 MM



C070541
8 X 160 MM

C070542
10 X 160 MM

C070543
12 X 160 MM

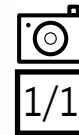

CISEAU A OS BURIN

BONE CHISEL

CISEAU A OS BURIN PUTTI 20 MM
PR ARTHROPLASTIE

C070544 *PUTTI BONE CHISEL 20 MM
FOR ARTHROPLASTY*



C070545
25 MM

C070546
27 MM

C070547
30 MM

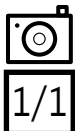

CISEAU A OS BURIN SENECHAL BOUTONNE

C070548 *SENECHAL BONE CHISEL BUTTONED*

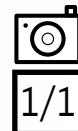

CISEAU A OS BURIN STILLE 8 X 210 MM PETIT MANCHE

C070550 *STILLE BONE CHISEL 8 X 210 MM SMALL HANDLE*



C070549
6 X 210 MM

C070551
10 X 210 MM

C070552
12 X 210 MM

C070553
15 X 210 MM

C070554
20 X 210 MM

C070555
25 X 210 MM

C070556
30 X 210 MM

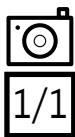

CISEAU A OS GOUGE

BONE GOUGE

CISEAU A OS GOUGE ALEXANDER 4 X 180 MM

C080557 ALEXANDER BONE GOUGE 4 X 180 MM



C080558
6 X 180 MM

C080559
8 X 180 MM

C080560
10 X 180 MM

C080561
12 X 180 MM

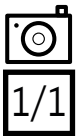

CISEAU A OS GOUGE BANKART AVEC ENCLUME

C080564 BANKART BONE GOUGE WITH ANVIL



CISEAU A OS GOUGE BALLENGER
4 X 150 MM

C080562 BALLENGER BONE
GOUGE 4 X 150 MM



C080563
6 X 150 MM

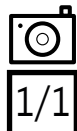

CISEAU A OS GOUGE CAUCHOIX
16 X 250 MM CONCAVE

C080565 CAUCHOIX BONE GOUGE
16 X 250 MM CONCAVE

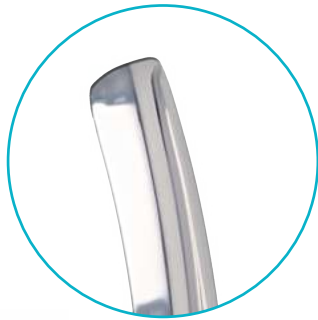

C080566
16 X 300 MM

C080567
18 X 250 MM

C080568
18 X 300 MM

C080569
20 X 250 MM

C080570
20 X 300 MM

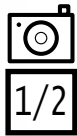

CISEAU A OS GOUGE CAUCHOIX
16 X 250 MM CONVEXE

C080571 CAUCHOIX BONE GOUGE
16 X 250 MM CONVEX

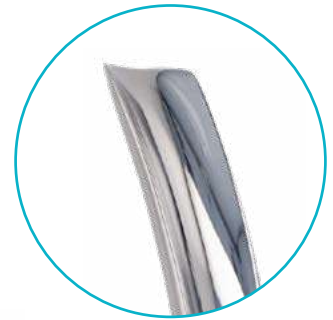

C080572
16 X 300 MM

C080573
18 X 250 MM

C080574
18 X 300 MM

C080575
20 X 250 MM

C080576
20 X 300 MM

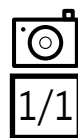
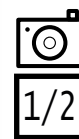

MANCHE ROND

ROUND HANDLE

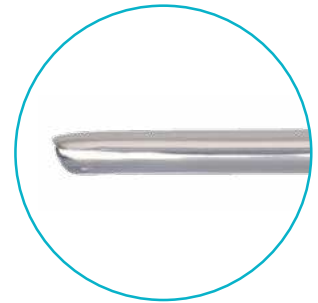

CISEAU A OS GOUGE COBB 6 X 300 MM DROIT MANCHE ROND

C080578 COBB BONE GOUGE 6 X 300 MM STRAIGHT ROUND HANDLE

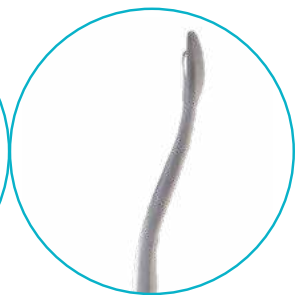
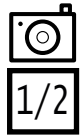

DROIT

STRAIGHT

DEMI COURBE

HALF CURVED

COURBE

CURVED

COUDE ARRIERE

ANGLE REAR

DIMENSIONS

DIMENSIONS

6 X 300 MM

C080578

C080580

C080577

8 X 240 MM

C080582

8 X 250 MM

C080579

8 X 280 MM

C080581

MANCHE HEXAGONALE

HEXAGONAL HANDLE

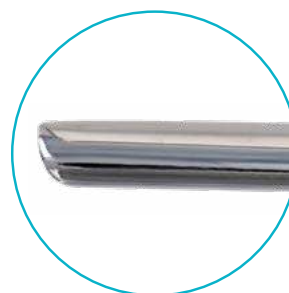

CISEAU A OS GOUGE COBB 8 X 280 MM MANCHE HEXAGONAL

C080584 *COBB BONE GOUGE 8 X 280 MM HEXAGONALE HANDLE*



LONGUEUR

LENGTH

280 MM

LARGEUR

WIDTH

6 MM

C080583

8 MM

C080584

10 MM

C080585

12 MM

C080586

CISEAU A OS GOUGE DEBURGE 8 X 240 MM DEMI COURBE

C080587 *DEBURGE BONE GOUGE 8 X 240 MM HALF CURVED*

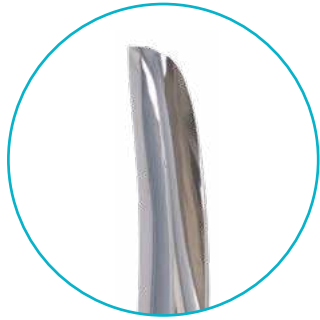

DEMI COURBE
HALF CURVED

COURBE
CURVED

TRES COURBE
VERY CURVED

DIMENSIONS
DIMENSIONS

8 X 240 MM

C080587

C080589

C080591

10 X 240 MM

C080588

C080590

C080592

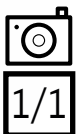

CISEAU A OS GOUGE FREER 6 X 150 MM
C080595 *FREER BONE GOUGE 6 X 150 MM*

CISEAU A OS GOUGE DUCROQUET 12 X 150 MM
C080593 *DUCROQUET BONE GOUGE 12 X 150 MM*

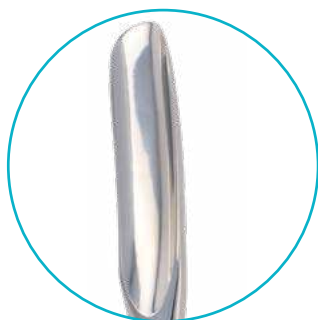

C080594
15 X 150 MM

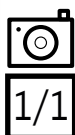

CISEAU A OS GOUGE

BONE GOUGE

CISEAU A OS GOUGE GUILLAUME 2 X 240 MM

C080596 *GUILLAUME BONE GOUGE 2 X 240 MM*

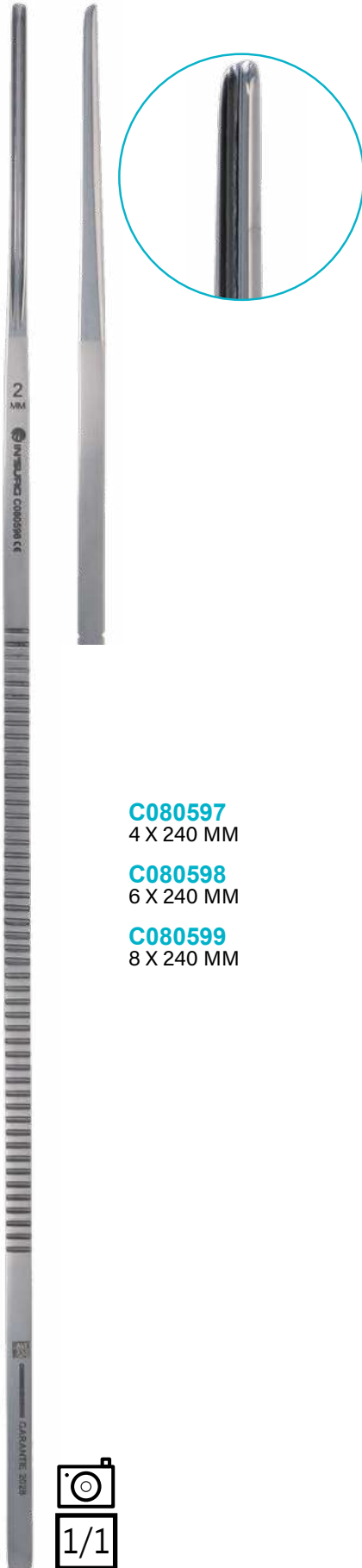

C080597
4 X 240 MM

C080598
6 X 240 MM

C080599
8 X 240 MM

CISEAU A OS GOUGE HAUTANT 1 X 130 MM

C080600 *HAUTANT BONE GOUGE 1 X 130 MM*



C080601
2 X 130 MM

C080602
3 X 130 MM

C080603
4 X 130 MM

C080604
5 X 130 MM

C080605
6 X 130 MM

C080606
8 X 130 MM

C080607
10 X 130 MM

C080608
12 X 130 MM

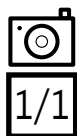

CISEAU A OS GOUGE HONTON 16 X 295 MM CONCAVE

C080609 HONTON BONE GOUGE 16 X 295 MM CONCAVE

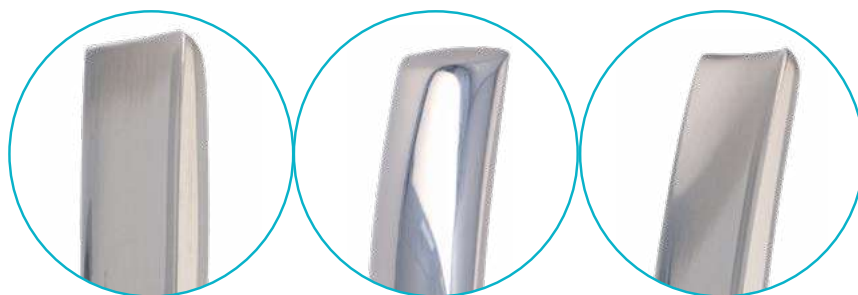

DROIT
STRAIGHT

CONCAVE
CONCAVE

CONVEXE
CONVEX

DIMENSIONS
DIMENSIONS

16 X 295 MM

C080611

C080609

C080610

CISEAU A OS GOUGE

BONE GOUGE

CISEAU A OS GOUGE KILLIAN 5 X 160 MM
BAÏONNETTE ROND

C080612 KILLIAN BONE GOUGE 5 X 160 MM
BAYONET ROUND FORM

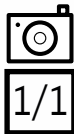

CISEAU A OS GOUGE KILLIAN 5 X 160 MM
BAÏONNETTE EN V

C080613 KILLIAN BONE GOUGE 5 X 160 MM
BAYONET V FORM

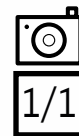

**CISEAU A OS GOUGE LETOURNEL
6 X 370 MM CIMENT**

C080614 *LETOURNEL BONE
GOUGE 6 X 370 MM
CEMENT*

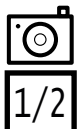
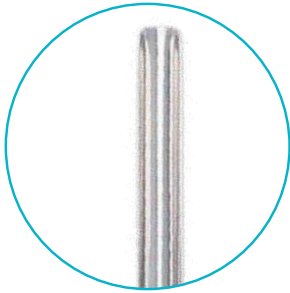

**CISEAU A OS GOUGE LEXER 15 X 220 MM MANCHE
SYNTHETIQUE**

C080624 *LEXER BONE GOUGE 15 X 220 MM SYNTHETIC HANDLE*



LARGEUR WIDTH	LONGUEUR LENGTH		
	180 MM	220 MM	320 MM
4 MM	C080615		
6 MM	C080616		
7 MM		C080617	C080618
8 MM	C080619		
10 MM	C080620	C080621	C080622
12 MM	C080623		
15 MM		C080624	
20 MM		C080625	
25 MM		C080626	
30 MM		C080627	

**CISEAU A OS GOUGE LEXER 10 X 275 MM
COUDE MANCHE SYNTHETIQUE**

C080628 *LEXER BONE GOUGE
10 X 275 MM SYNTHETIC
HANDLE ANGLED*

CISEAUX A OS GOUGE

BONE GOUGE

CISEAU A OS GOUGE 5 X 250 MM COURBE
MANCHE SYNTHETIQUE

C080631 *BONE GOUGE 5 X 250 MM CURVED
SYNTHETIC HANDLE*

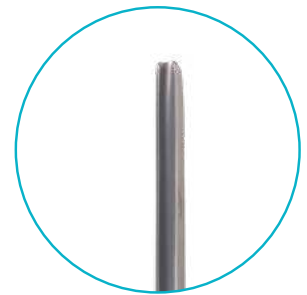
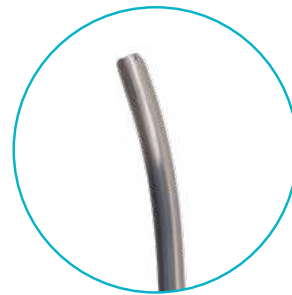

LARGEUR
WIDTH

COURBE
CURVED

DROIT
STRAIGHT

5 MM

C080631

C080630

10 MM

C080633

C080632

15 MM

C080635

C080634



CISEAU A OS GOUGE 10 X 250 MM DROIT MANCHE CELERON

C080641 BONE GOUGE 10 X 250 MM CELERON HANDLE STRAIGHT



LARGEUR WIDTH	COURBE CURVED	DROIT STRAIGHT
5 MM	C080637	C080640
10 MM	C080638	C080641
15 MM	C080639	C080642

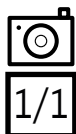

CISEAU A OS GOUGE MURPHY LEXER 280 MM COUDE ARRIERE CONVEXE

C080643 MURPHY LEXER BONE GOUGE 280 MM ANGLED BACKWARD CONVEXE



DROIT
STRAIGHT

CONCAVE
CONCAVE

CONVEXE
CONVEX

LONGUEUR
LENGTH

280 MM

C080645

C080644

C080643

CISEAU A OS GOUGE PARTSCH 4 X 140 MM
C080650 PARTSCH BONE GOUGE 4 X 140 MM



LARGEUR WIDTH	LONGUEUR LENGTH	
	140 MM	170 MM
2 MM	C080646	C080647
3 MM	C080648	C080649
4 MM	C080650	C080651
6 MM	C080652	C080653
8 MM	C080654	C080655

CISEAU A OS GOUGE

BONE GOUGE

CISEAU A OS GOUGE 1 X 145 MM PEDICURE

C080656 BONE GOUGE 1 X 145 MM PEDICURE



LARGEUR
WIDTH

LONGUEUR
LENGTH
145 MM

1.5 MM	C080657
2 MM	C080658
3 MM	C080659
4 MM	C080660
5 MM	C080661
6 MM	C080662
7 MM	C080663
8 MM	C080664
9 MM	C080665
10 MM	C080666
12 MM	C080667
13 MM	C080668
14 MM	C080669
15 MM	C080670

CISEAU A OS GOUGE POIRIER 8 X 160 MM

C080674 POIRIER BONE GOUGE 8 X 160 MM

CISEAU A OS GOUGE POIRIER TRILLAT
4 X 200 MM

C080678 POIRIER TRILLAT BONE GOUGE
4 X 200 MM



LARGEUR WIDTH	LONGUEUR LENGTH
	160 MM
2 MM	C080671
4 MM	C080672
6 MM	C080673
8 MM	C080674
10 MM	C080675
12 MM	C080676
14 MM	C080677

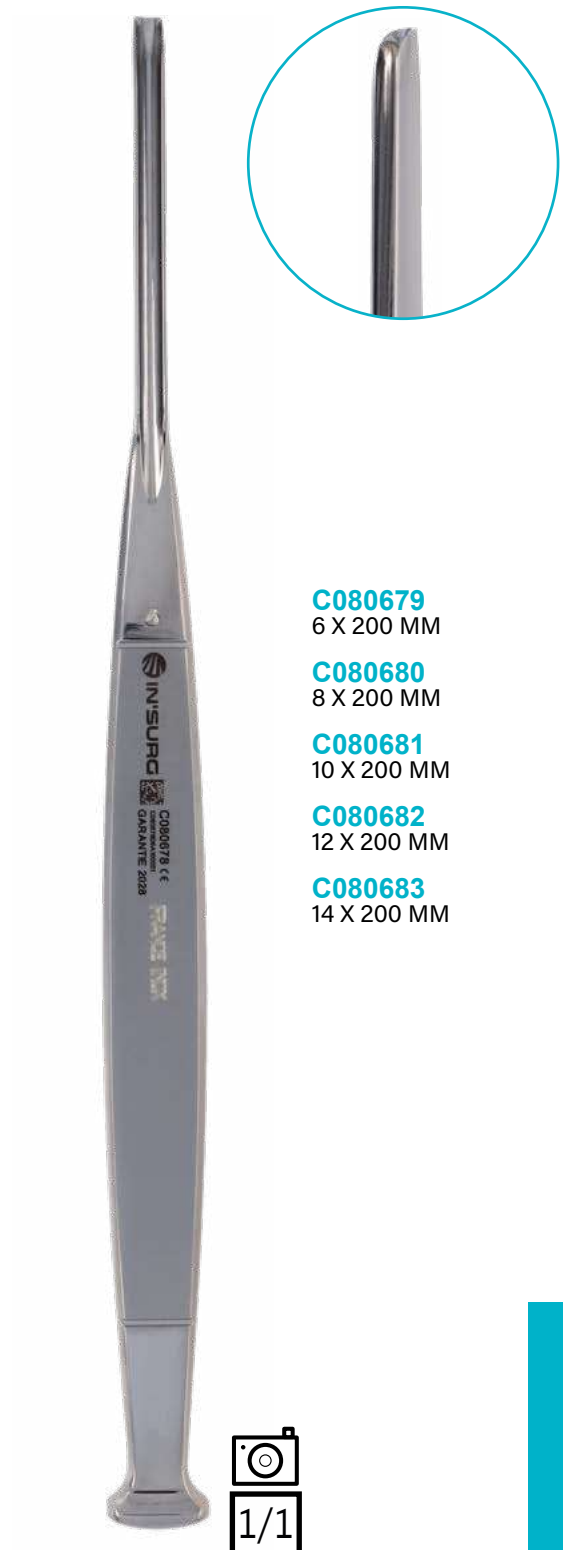
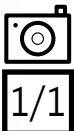

C080679
6 X 200 MM

C080680
8 X 200 MM

C080681
10 X 200 MM

C080682
12 X 200 MM

C080683
14 X 200 MM

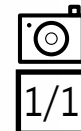

CISEAU A OS GOUGE

BONE GOUGE

CISEAU A OS GOUGE POSTEL 8 X 250 MM DROIT
C080686 POSTEL BONE GOUGE 8 X 250 MM STRAIGHT

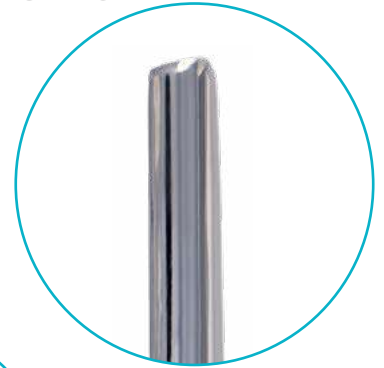

C080684
8 X 250 MM COUDE A 135°
ANGLED 135°

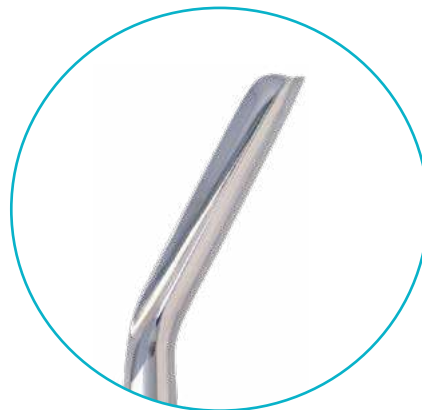

C080685
8 X 250 MM COUDE A 150°
ANGLED 150°

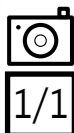

CISEAU A OS GOUGE PUTTI 30 X 250 MM

C080688 *PUTTI BONE GOUGE 30 X 250 MM*

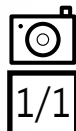

CISEAU A OS GOUGE

BONE GOUGE

CISEAU A OS GOUGE SMITH PETERSEN 20 X 235 MM COUDE

C080689 SMITH PETERSEN BONE GOUGE 20 X 235 MM ANGLED



DROIT
STRAIGHT

COURBE
CURVED

COUDE
ANGLED

LARGEUR
WIDTH

200 MM

200 MM

235 MM

6 MM

C080698

C080692

9 MM

C080693

10 MM

C080699

13 MM

C080700

C080694

19 MM

C080701

C080695

20 MM

C080689

25 MM

C080702

C080696

27 MM

C080690

30 MM

C080691

32 MM

C080703

C080697

CISEAU A OS GOUGE STAGNARA 10 X 300 MM MANCHE ROND

C080706 STAGNARA BONE GOUGE 10 X 300 MM ROUND HANDLE



LARGEUR <i>WIDTH</i>	LONGUEUR <i>LENGTH</i>
	300 MM
6 MM	C080704
8 MM	C080705
10 MM	C080706
12 MM	C080707
14 MM	C080708
16 MM	C080709
18 MM	C080710
20 MM	C080711

CISEAU A OS GOUGE STILLE 6 X 210 MM COURBE

C080712 STILLE BONE GOUGE 6 X 210 MM CURVED

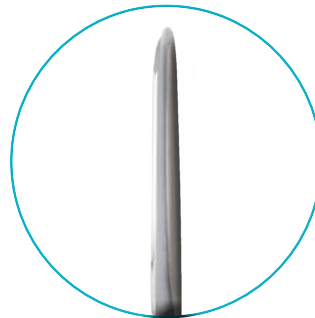
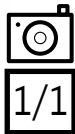

LARGEUR
WIDTH

DROIT
STRAIGHT

COURBE
CURVED

6 MM

C080718

C080712

8 MM

C080719

10 MM

C080720

C080713

12 MM

C080721

15 MM

C080722

C080714

20 MM

C080723

C080715

25 MM

C080724

C080716

30 MM

C080725

C080717

CISEAU A OS GOUGE WAGNER
9 X 340 MM DROIT MANCHE SYNTHETIQUE

C080732 WAGNER BONE GOUGE 9 X 340 MM
SYNTHETIC HANDLE STRAIGHT



DROIT
STRAIGHT
C080733
15 MM



COURBE EN AVANT
CURVED FORWARDS

C080730
15 MM

CISEAU A OS GOUGE ZIELKE
9 X 230 MM MANCHE SYNTHETIQUE

C080736 ZIELKER BONE GOUGE 9 X 230 MM
SYNTHETIC HANDLE



C080735
5.5 X 230 MM

CISEAU A OS GOUGE COBB
4 X 280 MM COUDE ARRIERE

C080737 *BONE SCISSORS GOUGE COBB
4 X 280 MM REAR ELBOW*



CISEAU A OS OSTEOTOME 5 X 180 MM
DOUBLE BOUTONNE

C090737 *BONE OSTEOTOME 5 X 180 MM
BUTTONED DOUBLE*



CISEAU A OS OSTEOTOME CAUCHOIX
8 X 250 MM

C090738 CAUCHOIX BONE OSTEOTOME
8 X 250 MM



C090739
10 X 250 MM

C090740
12 X 250 MM

C090741
14 X 250 MM

C090742
16 X 250 MM

C090743
18 X 250 MM

C090744
20 X 250 MM

C090745
25 X 250 MM



1/1

CISEAU A OS OSTEOTOME CLAQUE 5 X 160 MM
BOUTONNE TRANCHANT

C090746 *CLAQUE BONE OSTEOTOME 5 X 160 MM
SHARP BUTTONE*



CISEAU A OS OSTEOTOME COTTLE
4 X 180 MM GRADUE

C090747 *COTTLE BONE OSTEOTOME
4 X 180 MM GRADUATED*



C090748
6 X 180 MM

C090749
9 X 180 MM

C090750
12 X 180 MM

CISEAU A OS OSTEOTOME FARABEUF
10 X 210 MM GROS MANCHE

C090751 FARABEUF BONE OSTEOTOME
10 X 210 MM BIG HANDLE



CISEAU A OS OSTEOTOME LAMBOTTE
20 X 200 MM GRADUE AVEC POIGNEE EN T

C090796 LAMBOTTE BONE OSTEOTOME
20 X 200 MM GRADUATED WITH T
FORME HANDLE



CISEAU A OS OSTEOTOME LAMBOTTE
20 X 240 MM LAME FINE

C090799 LAMBOTTE BONE OSTEOTOME
20 X 240 MM BENT BLADE

LAME FINE
BENT BLADE

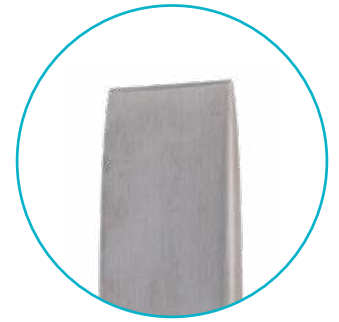

LARGEUR WIDTH	LONGUEUR LENGTH		
	125 MM	160 MM	240 MM
4 MM			C090761
5 MM	C090762		
6 MM		C090766	C090768
8 MM			C090773
10 MM	C090757	C090777	C090780
12 MM			C090785
14 MM		C090788	C090790
18 MM			C090793
20 MM		C090795	C090799
25 MM		C090801	C090803
30 MM		C090805	C090807
35 MM			C090810
40 MM			C090814
50 MM			C090818

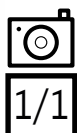

CISEAU A OS OSTEOTOME LAMBOTTE 4 X 125 MM

C090759 LAMBOTTE BONE OSTEOTOME 4 X 125 MM



LARGEUR WIDTH	LONGUEUR LENGTH		
	125 MM	160 MM	240 MM
3 MM	C090758		
4 MM	C090759		C090760
6 MM	C090763	C090764	C090767
8 MM	C090769	C090770	C090772
10 MM	C090774	C090775	C090778
12 MM	C090781	C090782	C090784
14 MM		C090787	C090789
20 MM		C090794	C090797
25 MM		C090800	C090802
30 MM		C090804	C090806
35 MM		C090808	C090809
40 MM		C090812	C090813
50 MM		C090816	C090817



CISEAU A OS OSTEOTOME

BONE OSTEOTOME

CISEAU A OS OSTEOTOME LAMBOTTE 10 X 240 MM COURBE

C090779 *LAMBOTTE BONE OSTEOTOME 10 X 240 MM CURVED*



LAME COURBE *CURVED BLADE*

LARGEUR <i>WIDTH</i>	LONGUEUR <i>LENGTH</i>	
	160 MM	240 MM
6 MM	C090765	
8 MM	C090771	
10 MM	C090776	C090779
12 MM	C090783	
15 MM		C090791
18 MM		C090792
20 MM		C090798

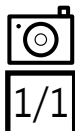

CISEAU A OS OSTEOTOME LEXER 15 X 220 MM MANCHE SYNTHETIQUE

C090832 LEXER BONE OSTEOTOME 15 X 220 MM SYNTHETIC HANDLE



DROIT
STRAIGHT



COUDE
ANGLED

LARGEUR
WIDTH

180 MM

220 MM

275 MM

4 MM

C090823

6 MM

C090824

7 MM

C090825

8 MM

C090826

10 MM

C090827

C090828

C090829

12 MM

C090830

15 MM

C090832

20 MM

C090834

25 MM

C090835

30 MM

C090836

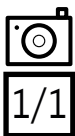

CISEAU A OS OSTEOTOME
MAC EVEN 10 X 200 MM
COURBE GRADUE

C090837 *MAC EVEN BONE
OSTEOTOME
10 X 200 MM
GRADUATED CURVED*

CISEAU A OS OSTEOTOME
MAC EVEN 10 X 200 MM
DROIT GRADUE

C090839 *MAC EVEN BONE
OSTEOTOME
10 X 200 MM
GRADUATED
STRAIGHT*

CISEAU A OS OSTEOTOME
MARCHAC 5 X 180 MM
BOUTONNE

C090841 *MARCHAC BONE
OSTEOTOME
5 X 180 MM BUTTONE*



C090838
15 X 200 MM

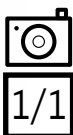

C090840
15 X 200 MM

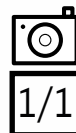

CISEAU A OS OSTEOTOME
MC INDOE 10 X 150 MM

C090842 *MAC INDOE BONE
OSTEOTOME
10 X 150 MM*

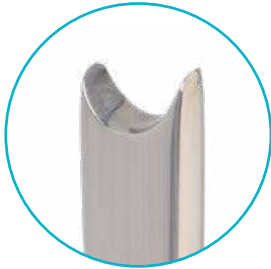

CISEAU A OS OSTEOTOME
OBWEGESER 4 X 185 MM
BOUTONNE DOUBLE

C090845 *OBWEGESER BONE
OSTEOTOME
4 X 185 MM DOUBLE
BUTTONED*

CISEAU A OS OSTEOTOME
OMBREDANNE 10 X 140 MM

C090846 *OMBREDANNE BONE
OSTEOTOME
10 X 140 MM*

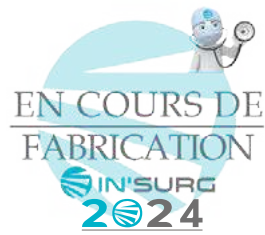

C090843
13 X 150 MM

C090844
15 X 150 MM

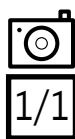

C090847
15 X 140 MM

C090848
20 X 140 MM

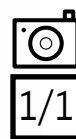

CISEAU A OS OSTEOTOME

BONE OSTEOTOME

CISEAU A OS OSTEOTOME POLLET
7 X 160 MM

C090849 *POLLET BONE OSTEOTOME
7 X 160 MM*



CISEAU A OS OSTEOTOME POLLET PECH
13 X 160 MM

C090850 *POLLET PECH BONE
OSTEOTOME 13 X 160 MM*



CISEAU A OS OSTEOTOME ROBIN
6 X 8 X 160 MM RHINOPLASTIE

C090851 *ROBIN BONE OSTEOTOME
6 X 8 X 160 MM RHINOPLASTY*



C090852
8 X 10 X 160 MM

C090853
8 X 12 X 160 MM

C090854
10 X 14 X 160 MM

C090855
12 X 16 X 160 MM

CISEAU A OS OSTEOTOME TESSIER
15 X 185 MM DEMI COURBE

C090872 *TESSIER BONE OSTEOTOME
15 X 185 DEMI CURVED*



CISEAU A OS OSTEOTOME TESSIER
15 X 210 MM DROIT

C090873 *TESSIER BONE OSTEOTOME
15 X 210 MM STRAIGHT*



C090874
20 X 210 MM



CISEAU A OS OSTEOTOME STILLE 12 X 210 MM
COURBE

C090859 *STILLE BONE OSTEOTOME 12 X 210 MM
CURVED*

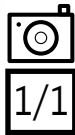

CISEAU A OS OSTEOTOME STILLE 6 X 210 MM
DROIT

C090864 *STILLE BONE OSTEOTOME 6 X 210 MM
STRAIGHT*

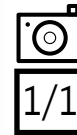

- C090858**
10 X 210 MM
- C090860**
15 X 210 MM
- C090861**
20 X 210 MM
- C090862**
25 X 210 MM
- C090863**
30 X 210 MM

- C090865**
8 X 210 MM
- C090866**
10 X 210 MM
- C090867**
12 X 210 MM
- C090868**
15 X 210 MM
- C090869**
20 X 210 MM
- C090870**
25 X 210 MM
- C090871**
30 X 210 MM

CISEAU CAPSULAIRE *CAPSULAR SCISSORS*

CISEAU CAPSULAIRE RESANO 245 MM COUDE
C100875 *RESANO CAPSULAR SCISSORS 245 MM ANGLED*

Les ciseaux à cartilage Resano sont utilisés par les chirurgiens plasticiens pour la dissection précise des tissus mous, y compris l'épaisseur du cartilage dans la rhinoplastie.

Également utilisé dans les chirurgies de la colonne vertébrale et cardiovasculaire pour une dissection précise des tissus délicats.

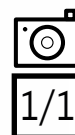

IN'SURG
ULTRA LINE

L'INSTRUMENT CHIRURGICAL
QUI VOUS CORRESPOND

Garantie totale
10 ANS
sans conditions

GARANTIE 10 ANS AVEC AFFÛTAGE OFFERT LES 5 PREMIÈRES ANNÉES !

AVANTAGE

**UNE LAME SABRE
ET
UNE LAME CRANTEE**

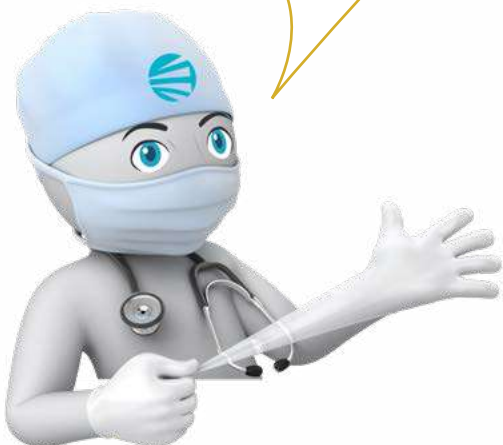

CISEAUX STANDARD

60 coupes
3 affûtages

L'affûtage se fait sur les deux lames ce qui enlève beaucoup de matière.

CISEAUX ULTRA LINE

2000 coupes
6 affûtages

L'affûtage se fait uniquement sur la lame sabre

UNE LONGEVITÉ SUPÉRIEURE !

CISEAUX COURANTS

SCISSORS

www.in-surg.fr



CISEAUX 145 MM COURBE MOUSSE
TUNGSTENE

C120897 *SCISSORS 145 MM CURVED
BLUNT TUNGSTEN*



CISEAUX 145 MM DROIT MOUSSE
TUNGSTENE

C120898 *SCISSORS 145 MM STRAIGHT
BLUNT TUNGSTEN*



CISEAUX 145 MM COURBE POINTU
TUNGSTENE

C120919 *SCISSORS 145 MM CURVED
SHARP TUNGSTEN*

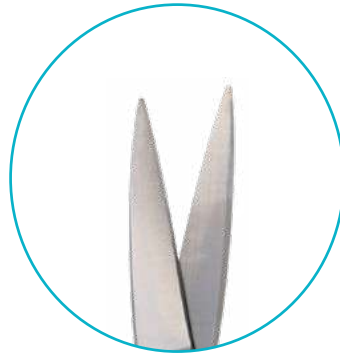

CISEAUX 145 MM DROIT POINTU
TUNGSTENE

C120920 *SCISSORS 145 MM STRAIGHT
SHARP TUNGSTEN*

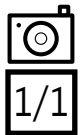

CISEAUX 145 MM COURBE MOUSSE POINTU
TUNGSTENE

C120912 *SCISSORS 145 MM CURVED
BLUNT SHARP TUNGSTEN*

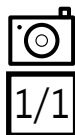

CISEAUX 145 MM DROIT MOUSSE POINTU
TUNGSTENE

C120914 *SCISSORS 145 MM STRAIGHT
BLUNT SHARP TUNGSTEN*

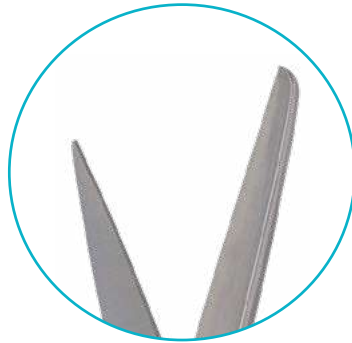
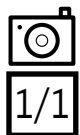

CISEAUX COURANTS

SCISSORS

CISEAUX 145 MM COURBE MOUSSE

C120903 *SCISSORS 145 MM CURVED BLUNT*

CISEAUX 145 MM DROIT MOUSSE

C120904 *SCISSORS 145 MM STRAIGHT BLUNT*



C120899
100 MM

C120901
120 MM

C120905
160 MM

C120907
180 MM

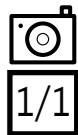

C120900
100 MM

C120902
120 MM

C120906
160 MM

C120908
180 MM

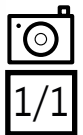

CISEAUX 145 MM COURBE POINTU

C120926 *SCISSORS 145 MM CURVED SHARP*

CISEAUX 145 MM DROIT POINTU

C120927 *SCISSORS 145 MM STRAIGHT SHARP*



C120921
100 MM

C120924
120 MM

C120928
160 MM

C120930
180 MM

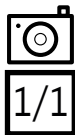

C120922
100 MM

C120925
120 MM

C120927
145 MM

C120929
160 MM

C120931
180 MM

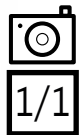

CISEAUX 160 MM COURBE MOUSSE POINTU

C120915 *SCISSORS 160 MM CURVED BLUNT SHARP*

CISEAUX 160 MM DROIT MOUSSE POINTU

C120916 *SCISSORS 160 MM STRAIGHT BLUNT SHARP*



C120909
120 MM

C120911
145 MM

C120917
180 MM



C120910
120 MM

C120913
145 MM

C120918
180 MM

CISEAUX 120 MM 1 LAME POINTUE ET 1 LAME BOUTONNEE

C120923 *SCISSORS 120 MM 1 BLADE SHARP AND 1 BLADE BUTONNED*



CISEAUX COOPER 130 MM COURBE MOUSSE

C120932 COOPER SCISSORS 130 MM CURVED BLUNT

CISEAUX COOPER 130 MM DROIT MOUSSE

C120933 COOPER SCISSORS 130 MM STRAIGHT BLUNT

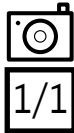
C120935
145 MMC120934
145 MM

CISEAUX COOPER 145 MM COURBE MOUSSE POINTU
C120938 COOPER SCISSORS 145 MM CURVED BLUNT SHARP

CISEAUX COOPER 145 MM DROIT MOUSSE POINTU
C120939 COOPER SCISSORS 145 MM STRAIGHT BLUNT SHARP



C120936
130 MM

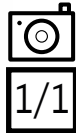

C120937
130 MM



CISEAUX COOPER 145 MM COURBE
POINTU

C120942 COOPER SCISSORS 145 MM
CURVED SHARP

CISEAUX COOPER 145 MM DROIT
POINTU

C120943 COOPER SCISSORS 145 MM
STRAIGHT SHARP



C120940
130 MM

C120942
145 MM



C120941
130 M

C120943
145 MM

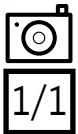

CISEAUX 125 MM COURBE MOUSSE
DELICAT

C120944 *SCISSORS 125 MM CURVED
BLUNT DELICATE*

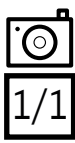

CISEAUX 125 MM DROIT MOUSSE
DELICAT

C120945 *SCISSORS 125 MM STRAIGHT
BLUNT DELICATE*

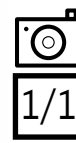

CISEAUX COURANTS

SCISSORS

CISEAUX POINTU DELICAT

SCISSORS SHARP DELICATE

CISEAUX 125 MM COURBE POINTU DELICAT

C120946 *SCISSORS 125 MM CURVED SHARP DELICATE*



COURBE
CURVED



DROIT
STRAIGHT

LONGUEUR
LENGTH

125 MM

C120946

C120947

CISEAUX MOUSSE POINTU DELICAT

SCISSORS BLUNT SHARP DELICATE



COURBE
CURVED



DROIT
STRAIGHT

LONGUEUR
LENGTH

125 MM

C120948

C120949

CISEAUX 130 MM COURBE ENUCLEATION

C120950 ENUCLEATION SCISSORS 130 MM
CURVED



CISEAUX 130 MM DROIT ENUCLEATION

C120951 ENUCLEATION SCISSORS 130 MM
STRAIGHT

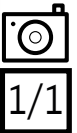

CISEAUX INCISION 145 MM SPATULE

C120953 INCISION SCISSORS 145 MM SPATULE

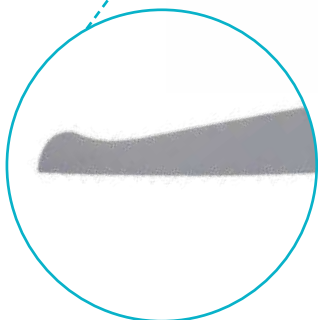
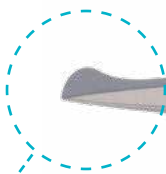

C120952
130 MM

C120954
165 MM

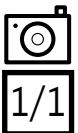

CISEAUX COURANTS

SCISSORS

CISEAUX 110 MM COURBE STRABISME

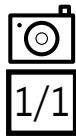
C121008 *STRABIMUS SCISSORS 110 MM
CURVED*

CISEAUX 110 MM DROIT STRABISME

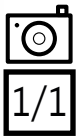
C121009 *STRABIMUS SCISSORS 110 MM
STRAIGHT*

CISEAUX MAYO 170 MM COURBE
ULTRA LINE

C120885 *ULTRA LINE MAYO SCISSORS
170 MM CURVED*

CISEAUX MAYO 170 MM DROIT
ULTRA LINE

C120886 *ULTRA LINE MAYO SCISSORS
170 MM STRAIGHT*



C120883
140 MM

C120887
230 MM

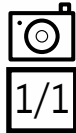

C120884
140 MM

C120888
230 MM

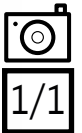

CISEAUX MAYO TUNGSTENE

MAYO SCISSORS TUNGSTEN

LONGUEUR LENGTH	COURBE CURVED	DROIT STRAIGHT
140 MM	C120962	C120965
170 MM	C120968	C120971
200 MM	C120973	C120975
280 MM	C120978	



CISEAUX MAYO 140 MM COURBE TUNGSTENE
C120962 MAYO SCISSORS 140 MM CURVED TUNGSTEN

CISEAUX MAYO

MAYO SCISSORS

LONGUEUR LENGTH	COURBE CURVED	DROIT STRAIGHT
140 MM	C120961	C120963
170 MM	C120966	C120969
200 MM	C120972	C120974
230 MM	C120976	C120977



CISEAUX MAYO 140 MM COURBE
C120961 MAYO SCISSORS 140 MM CURVED

**CISEAUX MAYO 170 MM COURBE
LAMES CRANTEES**

C120967 *MAYO SCISSORS 170 MM CURVED
SERRATED BLADES*

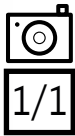

**CISEAUX MAYO 170 MM DROIT
LAMES CRANTEES**

C120970 *MAYO SCISSORS 170 MM
STRAIGHT SERRATED BLADES*



C120964
140 MM

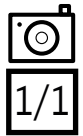

CISEAUX POUR GAUCHER

SCISSORS FOR LEFT-HANDED

CISEAUX MAYO 150 MM DROIT POUR GAUCHER

C120998 *MAYO SCISSORS 150 MM STRAIGHT FOR LEFT-HANDED*

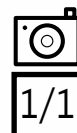

CISEAUX COURANTS

SCISSORS

CISEAUX MAYO DUBOST
230 MM COURBE TUNGSTENE

C120979 *MAYO DUBOST SCISSORS
230 MM CURVED TUNGSTEN*

CISEAUX MAYO DUBOST
230 MM DROIT TUNGSTENE

C120980 *MAYO DUBOST SCISSORS
230 MM STRAIGHT TUNGSTEN*

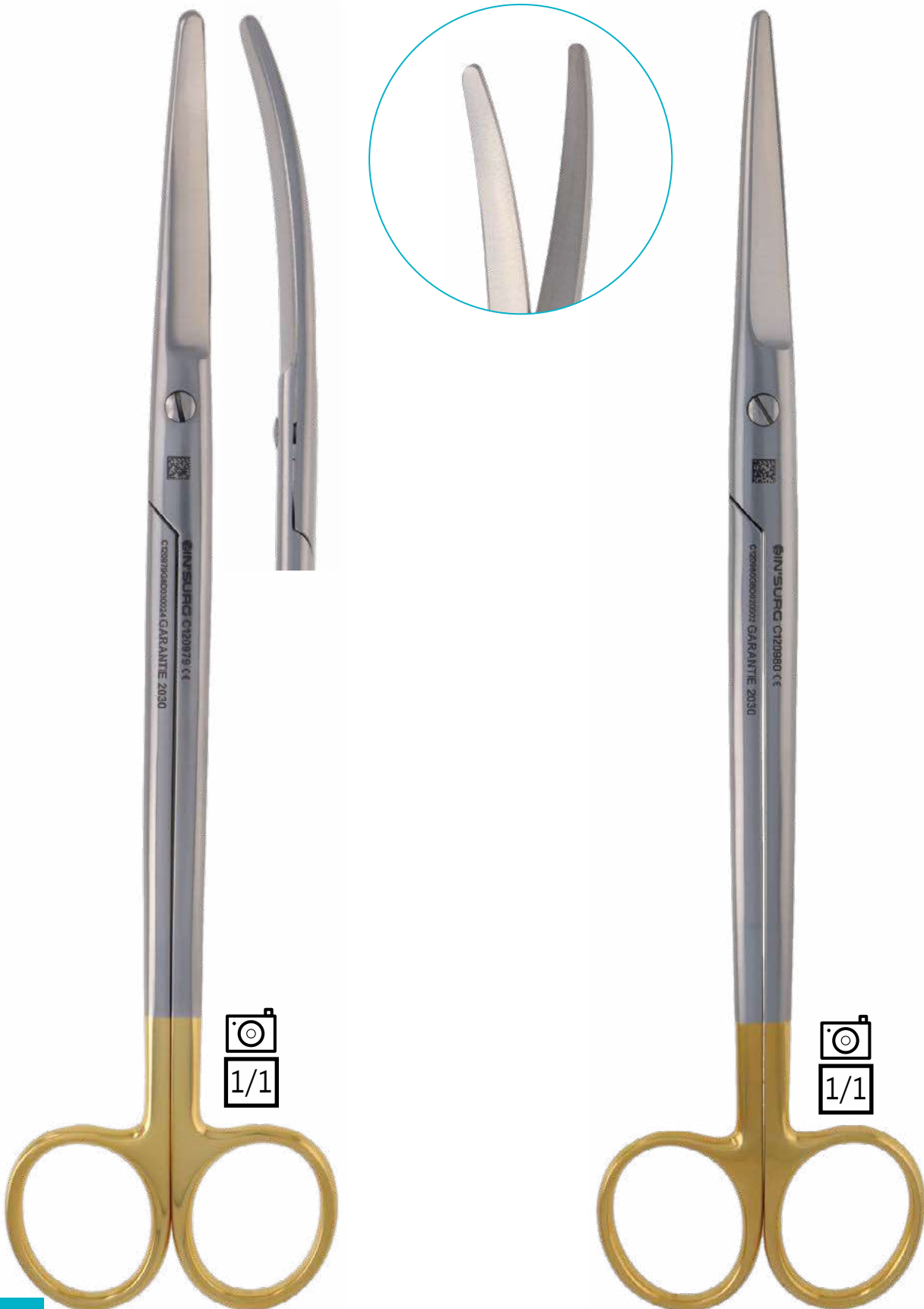

CISEAUX MAYO LEXER 165 MM COURBE TUNGSTENE

C120983 MAYO LEXER SCISSORS 165 MM CURVED



	COURBE CURVED	DROIT STRAIGHT
LONGUEUR LENGTH		
165 MM	C120983	C120984

CISEAUX MAYO LEXER 160 MM COURBE

C120981 MAYO LEXER SCISSORS 160 MM CURVED



	COURBE CURVED	DROIT STRAIGHT
LONGUEUR LENGTH		
160 MM	C120981	C120982
210 MM	C120985	

CISEAUX MAYO NOBLE 170 MM COURBE

C120986 MAYO NOBLE SCISSORS 170 MM CURVED

CISEAUX MAYO NOBLE 170 MM DROIT

C120987 MAYO NOBLE SCISSORS 170 MM STRAIGHT



CISEAUX MAYO 140 MM COURBE LAMES RONDES

C120988 MAYO SCISSORS 140 MM CURVED ROUND BLADES

CISEAUX MAYO 140 MM DROIT LAMES RONDES

C120989 MAYO SCISSORS 140 MM STRAIGHT ROUND BLADES



C120990
150 MM

C120992
170 MM

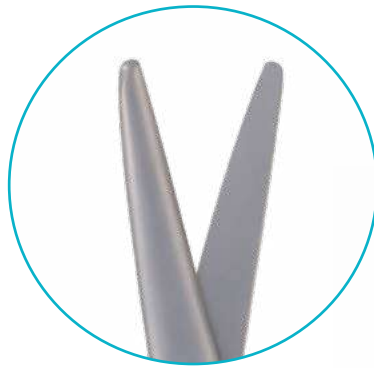
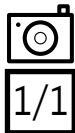

C120991
150 MM

C120993
170 MM

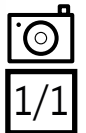

CISEAUX COURANTS

SCISSORS

CISEAUX MAYO SANTY 140 MM COUDE
C120994 MAYO SANTY SCISSORS 140 MM ANGLED

CISEAUX MAYO SANTY 170 MM
 COUDE SUR LE PLAT ULTRA LINE

C120890 ULTRA LINE MAYO SANTY SCISSORS
 170 MM ELBOW ON THE FLAT

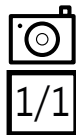

C120889
 140 MM



CISEAUX MAYO STILLE 150 MM COURBE TUNGSTENE

C120996 *MAYO STILLE SCISSORS 150 MM CURVED TUNGSTEN*

LONGUEUR LENGTH	COURBE CURVED	DROIT STRAIGHT
150 MM	C120996	C120999
170 MM	C121001	C121003
210 MM	C121005	C121007

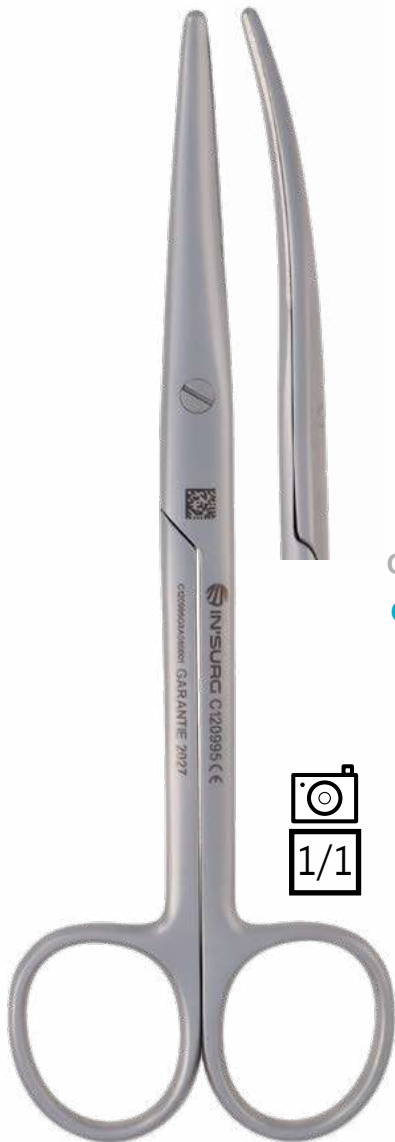

CISEAUX MAYO STILLE 150 MM COURBE

C120995 *MAYO STILLE SCISSORS 150 MM CURVED*

LONGUEUR LENGTH	COURBE CURVED	DROIT STRAIGHT
150 MM	C120995	C120997
170 MM	C121000	C121002
210 MM	C121004	C121006

CISEAUX MAYO STILLE 150 MM COURBE
ULTRA LINE

C120891 *ULTRA LINE MAYO STILLE
SCISSORS 150 MM CURVED*

CISEAUX MAYO STILLE 150 MM DROIT
ULTRA LINE

C120892 *ULTRA LINE MAYO STILLE
SCISSORS 150 MM STRAIGHT*



C120893
170 MM

C120895
190 MM

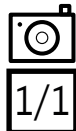

C120894
170 MM

C120896
195 MM

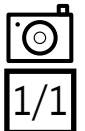

DISSECTING SCISSORS

CISEAUX DISSECTEURS 115 MM COURBE
A IRIS ULTRA LINE

C131010 *ULTRA LINE IRIS SCISSORS
115 MM CURVED*

CISEAUX DISSECTEURS 115 MM DROIT
A IRIS ULTRA LINE

C131011 *ULTRA LINE IRIS SCISSORS
115 MM STRAIGHT*



CISEAUX DISSECTEURS

DISSECTING SCISSORS

CISEAUX 90 MM COURBE IRIDECTOMIE
C120955 IRIDECTOMY SCISSORS 90 MM CURVED



CISEAUX 95 MM DROIT IRIDECTOMIE
C120956 IRIDECTOMY SCISSORS 95 MM STRAIGHT



CISEAUX 115 MM COURBE IRIDECTOMIE
 TUNGSTENE

C120959 IRIDECTOMY SCISSORS 115 MM
 CURVED TUNGSTEN



CISEAUX 115 MM DROIT IRIDECTOMIE
 TUNGSTENE

C120960 IRIDECTOMY SCISSORS 115 MM
 STRAIGHT TUNGSTEN



CISEAUX DISSECTEURS ALLAINES
140 MM COURBE

C131013 *ALLAINES DISSECTING SCISSORS
140 MM CURVED*

CISEAUX DISSECTEURS ALLAINES
140 MM DROIT

C131014 *ALLAINES DISSECTING SCISSORS
140 MM STRAIGHT*



CISEAUX DISSECTEURS ALLAINES 150 MM
COURBE EN S ULTRA LINE

C131028 *ULTRA LINE ALLAINES
DISSECTING SCISSORS 150 MM
CURVED S FORM*

CISEAUX DISSECTEURS ALLAINES SUEDOIS
180 MM EN S ULTRA LINE

C131037 *ULTRA LINE ALLAINES SWEDISH
DISSECTING SCISSORS 180 MM S FORM*

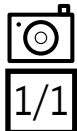

C131030
180 MM

C131032
200 MM

C131034
230 MM

C131036
260 MM

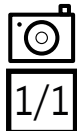

CISEAUX DISSECTEURS ALLAINES
180 MM COURBE EN S

C131016 *ALLAINES DISSECTING SCISSORS
180 MM CURVED S FORM*

CISEAUX DISSECTEURS ALLAINES
180 MM COURBE EN S TUNGSTENE

C131012 *ALLAINES DISSECTING SCISSORS
180 MM CURVED TUNGSTEN S FORME*

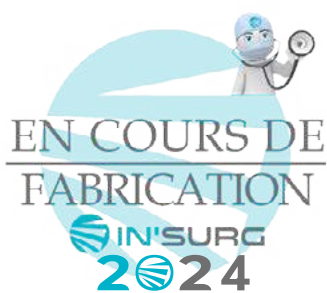

C131019
200 MM

C131022
230 MM

C131023
230 MM



CISEAUX DISSECTEURS ALLAINES 145 MM COURBE ERGONOMIC ULTRA LINE

C131027 *ULTRA LINE ALLAINES DISSECTING SCISSORS 145 MM ERGONOMIC CURVED*

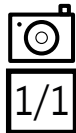

C131029
180 MM

C131031
200 MM

C131033
230 MM

C131035
260 MM

CISEAUX DISSECTEURS BOYD 180 MM EN S

C131038 *BOYD DISSECTING SCISSORS 180 MM S FORM*

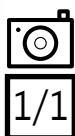

CISEAUX DISSECTEURS DEMARTEL 190 MM
COUDE SUR LE PLAT

C131047 *DEMARTEL DISSECTING SCISSORS 190
MM ANGLED ON THE FLAT*

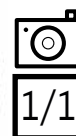

CISEAUX DISSECTEURS

DISSECTING SCISSORS

CISEAUX DISSECTEURS DEMARTEL 145 MM
COURBE TRES DELICAT TUNGSTENE

C131039 *DEMARTEL DISSECTING SCISSORS 145 MM
CURVED VERY DELICATE TUNGSTEN*

CISEAUX DISSECTEURS DEMARTEL
140 MM COURBE

C131043 *DEMARTEL DISSECTING SCISSORS
140 MM CURVED*

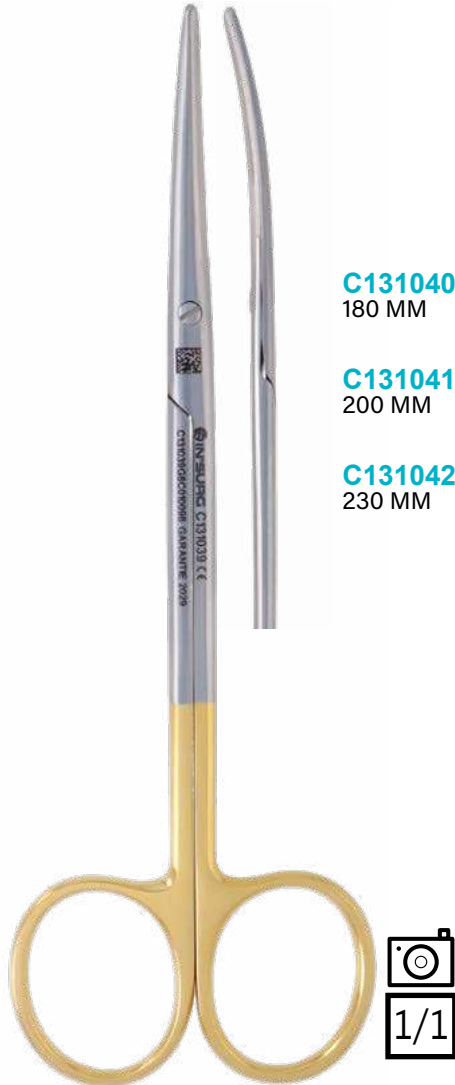

C131040
180 MM

C131041
200 MM

C131042
230 MM



C131044
180 MM

C131048
200 MM

C131049
230 MM

CISEAUX DISSECTEURS DEMARTEL 180 MM COURBE POINTU

C131045 *DEMARTEL DISSECTING SCISSORS 180 MM CURVED SHARP*



	COURBE CURVED	DROIT STRAIGHT
LONGUEUR LENGTH	C131045	C131046
180 MM		

CISEAUX DISSECTEURS DUBOST 210 MM COURBE ULTRA LINE

C131050 *ULTRA LINE DUBOST DISSECTING SCISSORS 210 MM CURVED*



LONGUEUR
LENGTH

210 MM

250 MM

300 MM

COURBE
CURVED

DROIT
STRAIGHT

C131050

C131051

C131057

C131058

C131059

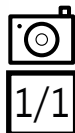



CISEAUX DISSECTEURS DUBOST 230 MM COURBE

C131052 *DUBOST DISSECTING SCISSORS 230 MM CURVED*

	COURBE CURVED	DROIT STRAIGHT
LONGUEUR LENGTH		
230 MM	C131052	C131053
250 MM	C131054	C131055
300 MM	C131056	



CISEAUX DISSECTEURS JAMESON
180 MM COURBE

C131060 JAMESON DISSECTING SCISSORS
180 MM CURVED

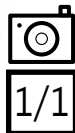

CISEAUX DISSECTEURS JAMESON 145 MM
COURBE ULTRA LINE

C131061 ULTRA LINE JAMESON DISSECTING SCISSORS
145 MM CURVED



C131062
180 MM

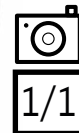

CISEAUX DISSECTEURS

DISSECTING SCISSORS

CISEAUX DISSECTEURS LEXER-BABY
105 MM COURBE

C131063 LEXER-BABY DISSECTING SCISSORS
105 MM CURVED

CISEAUX DISSECTEURS LEXER-BABY
105 MM DROIT

C131064 LEXER-BABY DISSECTING SCISSORS
105 MM STRAIGHT

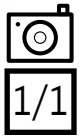
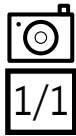
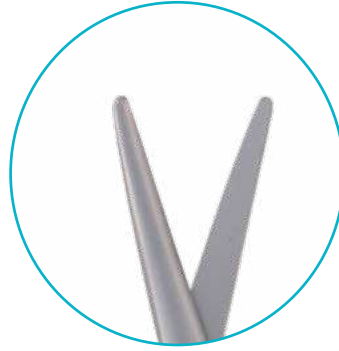

CISEAUX DISSECTEURS LEXER-BABY
115 MM COURBE TUNGSTENE

C131065 LEXER-BABY DISSECTING SCISSORS
115 MM CURVED TUNGSTEN

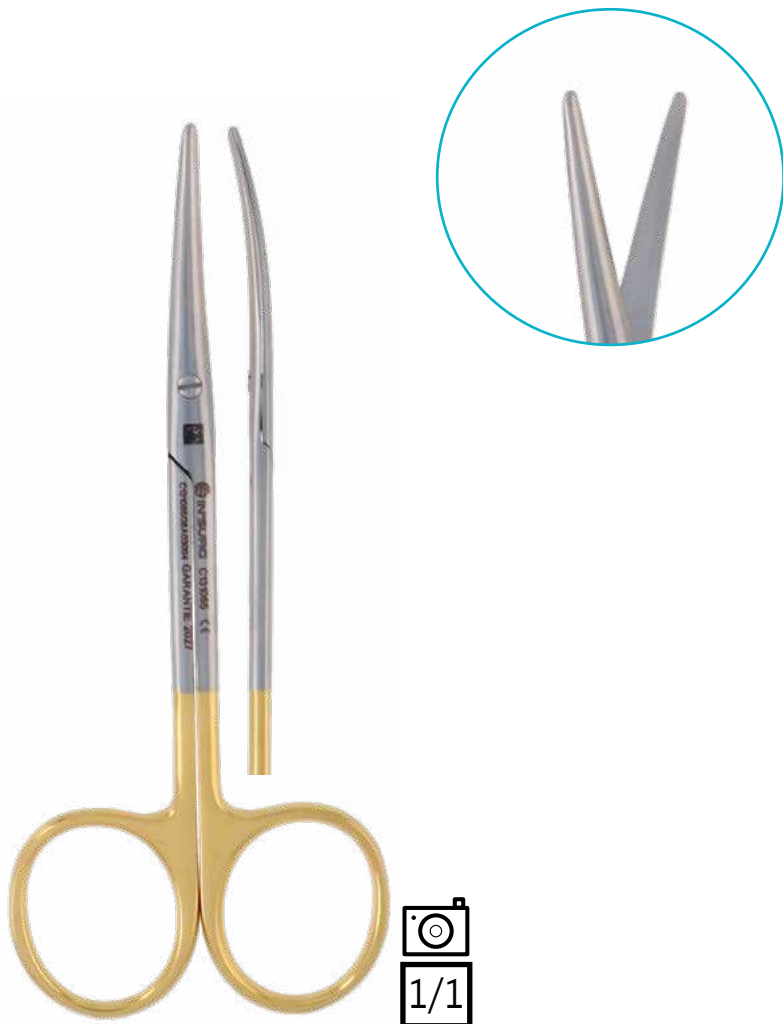

CISEAUX DISSECTEURS LEXER-BABY
115 MM DROIT TUNGSTENE

C131066 LEXER-BABY DISSECTING SCISSORS
115 MM STRAIGHT TUNGSTEN



CISEAUX DISSECTEURS MC INDOE 190 MM DROIT

C131067 MC INDO DISSECTING SCISSORS 190 MM STRAIGHT



CISEAUX DISSECTEURS MERVEILLEUX 175 MM COURBE ULTRA LINE

C131069 *ULTRA LINE MERVEILLEUX DISSECTING SCISSORS 175 MM CURVED*



LONGUEUR
LENGTH

COURBE
CURVED

DROIT
STRAIGHT

170 MM

C131068

175 MM

C131069

CISEAUX DISSECTEURS METZENBAUM-NELSON 140 MM COURBE

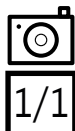
C131072 METZENBAUM-NELSON DISSECTING SCISSORS 140 MM CURVED

LONGUEUR LENGTH	COURBE CURVED	DROIT STRAIGHT
115 MM	C131070	C131071
140 MM	C131072	C131073
180 MM	C131078	C131081
200 MM	C131084	C131087
230 MM	C131090	C131093
250 MM	C131097	C131099
300 MM	C131103	C131105

CISEAUX DISSECTEURS METZENBAUM-NELSON 145 MM COURBE TUNGSTENE

C131074 METZENBAUM-NELSON DISSECTING SCISSORS 145 MM CURVED TUNGSTEN

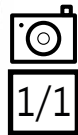

LONGUEUR LENGTH	COURBE CURVED	DROIT STRAIGHT
145 MM	C131074	C131076
180 MM	C131079	C131082
200 MM	C131085	C131088
230 MM	C131091	C131094
250 MM	C131098	C131100
300 MM	C131104	

CISEAUX DISSECTEURS METZENBAUM-NELSON 145 MM COURBE DELICAT TUNGSTENE

C131075 METZENBAUM-NELSON DISSECTING SCISSORS 145 MM TUNGSTEN DELICATE CURVED



LONGUEUR LENGTH	COURBE CURVED	DROIT STRAIGHT
145 MM	C131075	C131077
180 MM	C131080	C131083
200 MM	C131086	C131089
230 MM	C131092	C131095
260MM	C131101	
280 MM	C131102	

CISEAUX DISSECTEURS

DISSECTING SCISSORS

CISEAUX DISSECTEURS METZENBAUM-NELSON
230 MM EN S TRES DELICAT TUNGSTENE

C131096 METZENBAUM-NELSON DISSECTING SCISSORS
230 MM TUNGSTEN VERY DELICATE S FORM

CISEAUX DISSECTEURS METZENBAUM
180 MM COURBE ERGONOMIC ULTRA LINE

C131110 ULTRA LINE METZENBAUM-NELSON
DISSECTING SCISSORS 180 MM ERGONOMIC
CURVED

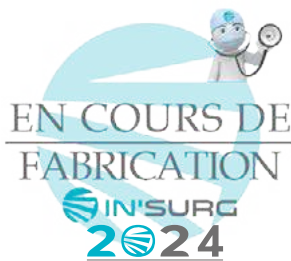

C131107
145 MM

C131113
200 MM

C131116
230 MM

C131119
250 MM



CISEAUX DISSECTEURS METZENBAUM-BABY
115 MM COURBE ULTRA LINE

C131121 *ULTRA LINE METZENBAUM-BABY DISSECTING
SCISSORS 115 MM CURVED*

CISEAUX DISSECTEURS METZENBAUM-BABY
115 MM DROIT ULTRA LINE

C131122 *ULTRA LINE METZENBAUM-BABY DISSECTING
SCISSORS 115 MM STRAIGHT*

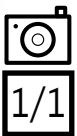
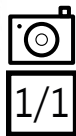

CISEAUX DISSECTEURS METZENBAUM 145 MM COURBE ULTRA LINE

C131106 *ULTRA LINE METZENBAUM DISSECTING SCISSORS 145 MM CURVED*



LONGUEUR LENGTH	COURBE CURVED	DROIT STRAIGHT
145 MM	C131106	C131108
180 MM	C131109	C131111
200 MM	C131112	C131114
230 MM	C131115	C131117
250 MM	C131118	
280 MM	C131120	

CISEAUX DISSECTEURS METZENBAUM 145 MM COURBE DELICAT ULTRA LINE

C131123 *ULTRA LINE METZENBAUM DISSECTING SCISSORS 145 MM DELICATE CURVED*

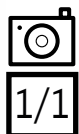

LONGUEUR LENGTH	COURBE CURVED	DROIT STRAIGHT
	145 MM	C131123
180 MM	C131125	C131126
200 MM	C131127	C131128
230 MM	C131129	C131130

CISEAUX DISSECTEURS POTTS SMITH 190 MM COUDE A 25° ULTRA LINE

C131131 *ULTRA LINE POTTS SMITH DISSECTING SCISSORS 190 MM ANGLED 25°*



COUDE A 25°
ANGLED 25°



COUDE A 45°
ANGLED 45°



COUDE A 60°
ANGLED 60°

LONGUEUR
LENGTH

190 MM

C131131

C131132

C131133

230 MM

C131134

C131135

C131136

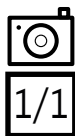

CISEAUX DISSECTEURS SATINSKY 250 MM EN S
UROLOGIE ULTRA LINE

C131137 *ULTRA LINE SATINSKY SCISSORS 250 MM S FORM
UROLOGY*



CISEAUX DISSECTEURS

DISSECTING SCISSORS

CISEAUX DISSECTEURS STEVENS
110 MM COURBE ULTRA LINE

C131138 *ULTRA LINE STEVENS DISSECTING
SCISSORS 110 MM CURVED*

CISEAUX DISSECTEURS STEVENS
110 MM DROIT ULTRA LINE

C131139 *ULTRA LINE STEVENS DISSECTING
SCISSORS 110 MM STRAIGHT*

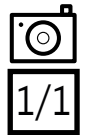

ENTEROTOMY SCISSORS

CISEAUX 210 MM ENTEROTOMES FIGURE 1
C141140 ENTEROTOMY SCISSORS 210 MM FIG 1

CISEAUX 210 MM ENTEROTOMES FIGURE 2
C141140 ENTEROTOMY SCISSORS 210 MM FIG 2

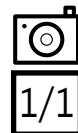
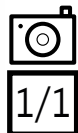

CISEAUX FILS

WIRE SCISSORS

CISEAUX FILS ACIER UNIVERSEL 120 MM
C151151 *UNIVERSAL STEEL WIRE SCISSORS 120 MM*



CISEAUX FILS ACIER UNIVERSEL 120 MM
 TUNGSTENE
C151152 *UNIVERSAL STEEL WIRE SCISSORS
 120 MM TUNGSTEN*



CISEAUX FILS BEEBE 120 MM COURBE 1 LAME CRANTEE
C151142 *BEEBE WIRE SCISSORS 120 MM CURVED SERRATED*

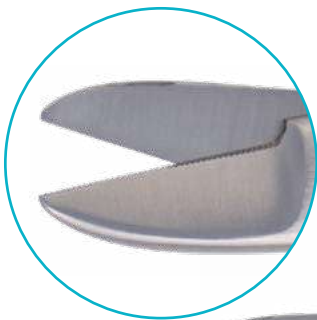

C151143
 120 MM - DROIT
 STRAIGHT



CISEAUX FILS SPENCER 110 MM COURBE

C151147 *SPENCER WIRE SCISSORS S110
MM CURVED*



CISEAUX FILS SPENCER 110 MM DROIT

C151148 *SPENCER WIRE SCISSORS 110 MM
STRAIGHT*



CISEAUX FILS HARVEY 120 MM

C151144 *HARVEY WIRE SCISSORS 120 MM*



CISEAUX GYNECO BRAUN STADLER 200 MM

C161154 *BRAUN STADLER GYNECO SCISSORS 200 MM*

CISEAUX GYNECO BUSCH 130 MM

C161155 *BUSH GYNECO SCISSORS 130 MM*



C161153
140 MM

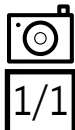

C161156
160 MM

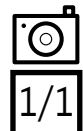

CISEAUX GYNECO DELESTRE 140 MM
EPISIOTOMIE

C161157 *DELESTRE GYNECO SCISSORS
140 MM FOR EPISIOTOMY*



CISEAUX GYNECO DELESTRE 180 MM
MOUSSE EPISIOTOMIE

C161158 *DELESTRE GYNECO SCISSORS
180 MM BLUNT FOR EPISIOTOMY*



GYNECO SCISSORS

CISEAUX GYNECO DOYEN 185 MM COURBE

C161159 *DOYEN GYNECO SCISSORS 185 MM CURVED*

CISEAUX GYNECO DOYEN 185 MM DROIT

C161160 *DOYEN GYNECO SCISSORS 185 MM STRAIGHT*



CISEAUX GYNECO DUBOIS 270 MM
COURBE

C161161 *DUBOIS GYNECO SCISSORS
270 MM CURVED*



CISEAUX GYNECO DUBOIS 270 MM
DROIT

C161162 *DUBOIS GYNECO SCISSORS 270 MM
STRAIGHT*



CISEAUX GYNECO

GYNECO SCISSORS

CISEAUX GYNECO 190 MM DROIT LAMES
LONGUES EPISIOTOMIE

C161163 GYNECO SCISSORS 190 MM
STRAIGHT LONG BLADES

CISEAUX GYNECO SCHUMACHER 155 MM

C161164 SCHUMACHER GYNECO SCISSORS 155 MM

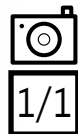
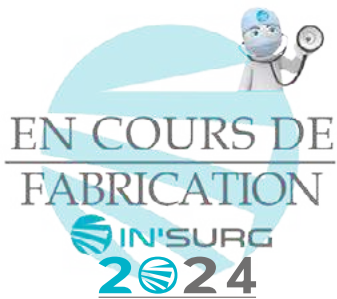

CISEAUX GYNECO SIMS 200 MM COURBE
MOUSSE

C161165 SIMS GYNECO SCISSORS 200 MM CURVED
BLUNT

CISEAUX GYNECO SIMS 200 MM DROIT
MOUSSE

C161166 SIMS GYNECO SCISSORS 200 MM
STRAIGHT BLUNT

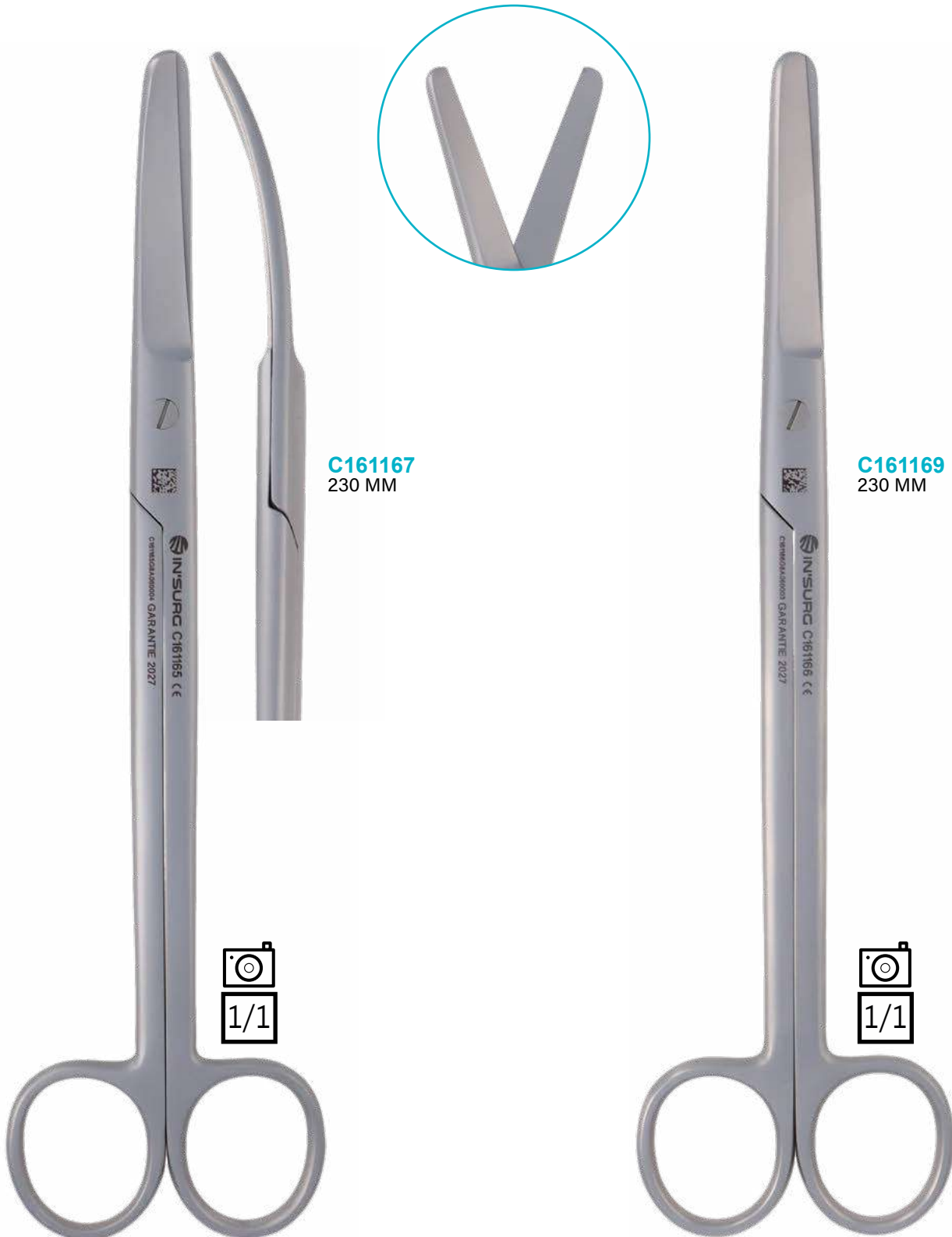

C161167
230 MM

C161169
230 MM

CISEAUX GYNECO

GYNECO SCISSORS

CISEAUX GYNECO SIMS 230 MM COURBE
MOUSSE TUNGSTENE

C161168 SIMS GYNECO SCISSORS 230 MM
CURVED TUNGSTEN BLUNT

CISEAUX GYNECO SIMS 230 MM COURBE
MOUSSE ULTRA LINE

C161177 ULTRA LINE SIMS GYNECO SCISSORS
230 MM CURVED BLUNT



IN'SURG
ULTRA LINE

Garantie totale
10 ANS
sans conditions

C161176
200 MM

CISEAUX GYNECO SIMS SIEBOLD 245 MM EN S

C161170 SIMS SIEBOLD GYNECO SCISSORS 245 MM S FORM

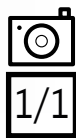

CISEAUX GYNECO SIMS SIEBOLD 250 MM DROIT

C161171 SIMS SIEBOLD GYNECO SCISSORS 250 MM STRAIGHT

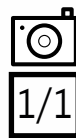

CISEAUX GYNECO

GYNECO SCISSOR

CISEAUX GYNECO US MODELE 105 MM

C161172 *US MODELE GYNECO SCISSORS
105 MM*

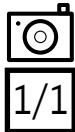

CISEAUX GYNECO 200 MM EPISIOTOMIE ULTRA LINE

C161173 *ULTRA LINE GYNECO SCISSORS 200 MM
FOR EPISIOTOMY*



IN'SURG
ULTRA LINE

Garantie
totale
10 ANS
sans conditions



CISEAUX GYNECO PARAMETRIUM
230 MM FAIBLE COURBURE ULTRA LINE

C161174 *ULTRA LINE GYNECO PARAMETRIUM
SCISSORS 230 MM LOW CURVATURE*

CISEAUX GYNECO PARAMETRIUM
230 MM GRANDE COURBURE ULTRA LINE

C161175 *ULTRA LINE GYNECO PARAMETRIUM
SCISSORS 230 MM LARGE CURVATURE*

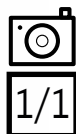
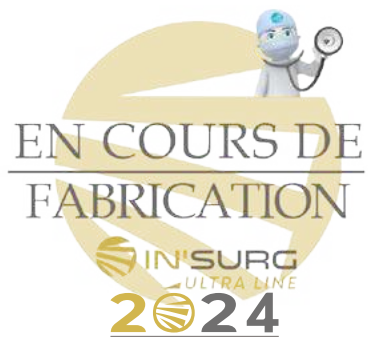

CISEAUX MICRO

MICRO SCISSORS

CISEAUX MICRO 180 MM COUDE A 45° CORPS
ROND 1 LAME POINTE BOULE 1 X 0,4 X 0,4 MM

C171179 *MICRO SCISSORS 180 MM 1 X 0,4 X 0,4 MM
ROUND BODY ANGLED 45° 1 BALL POINT
BLADE*

CISEAUX MICRO 165 MM COUDE A 25°
CORPS ROND

C171178 *MICRO SCISSORS 165 MM
ROUND BODY ANGLED 25°*

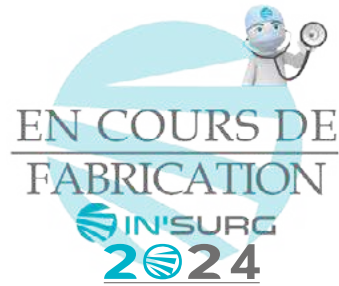
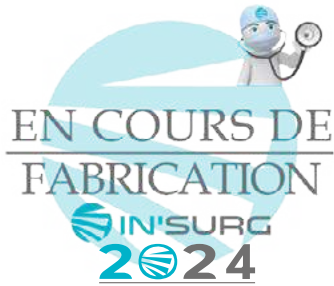

CISEAUX MICRO 130 MM COURBE CORPS ROND
C171191 MICRO SCISSORS 130 MM ROUND BODY CURVED

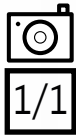

CISEAUX MICRO CORPS ROND
 MICRO SCISSORS ROUND BODY



COURBE
 CURVED

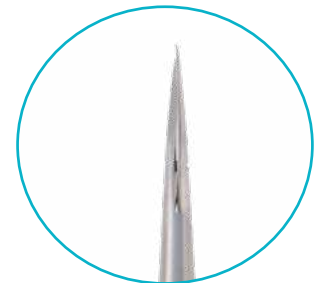

DROIT
 STRAIGHT

LONGUEUR
 LENGTH

130 MM

C171191

C171193

150 MM

C171194

C171195

180 MM

C171197

C171199

CISEAUX MICRO 110 MM COURBE CORPS PLAT
C171185 MICRO SCISSORS 110 MM FLAT BODY CURVED

CISEAUX MICRO CORPS PLAT
 MICRO SCISSORS FLAT BODY



COURBE
 CURVED



DROIT
 STRAIGHT

LONGUEUR
 LENGTH

110 MM

C171185

C171186

140 MM

C171187

150 MM

C171189



CISEAUX MICRO

MICRO SCISSORS

CISEAUX MICRO 130 MM COURBE LAMES LONGUES CORPS ROND

C171192 MICRO SCISSORS 130 MM ROUND BODY CURVED LONG BLADE



CISEAUX MICRO 150 MM DROIT 1 LAME CRANTEE CORPS ROND

C171196 MICRO SCISSORS 150 MM ROUND BODY STRAIGHT SERRATED BLADE

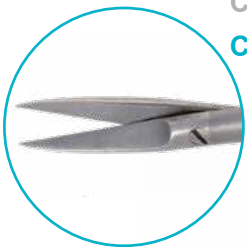

CISEAUX MICRO 150 MM COURBE 1 LAME CRANTEE CORPS PLAT

C171188 MICRO SCISSORS 150 MM FLAT BODY CURVED SERRATED BLADE



C171190
DROIT
STRAIGHT



C171188
COURBE
CURVED

**CISEAUX MICRO 180 MM COURBE
CORPS ROND LAMES LONGUES**

C171198 *MICRO SCISSORS 180 MM
ROUND BODY CURVED LONG
BLADES*

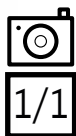

**CISEAUX MICRO 180 MM DROIT
CORPS ROND LAMES LONGUES**

C171200 *MICRO SCISSORS 180 MM
ROUND BODY STRAIGHT LONG
BLADES*



CISEAUX MICRO

MICRO SCISSORS

CISEAUX MICRO FAHLBUCH 165 MM

C171201 FAHLBUCH MICRO SCISSORS 165 MM

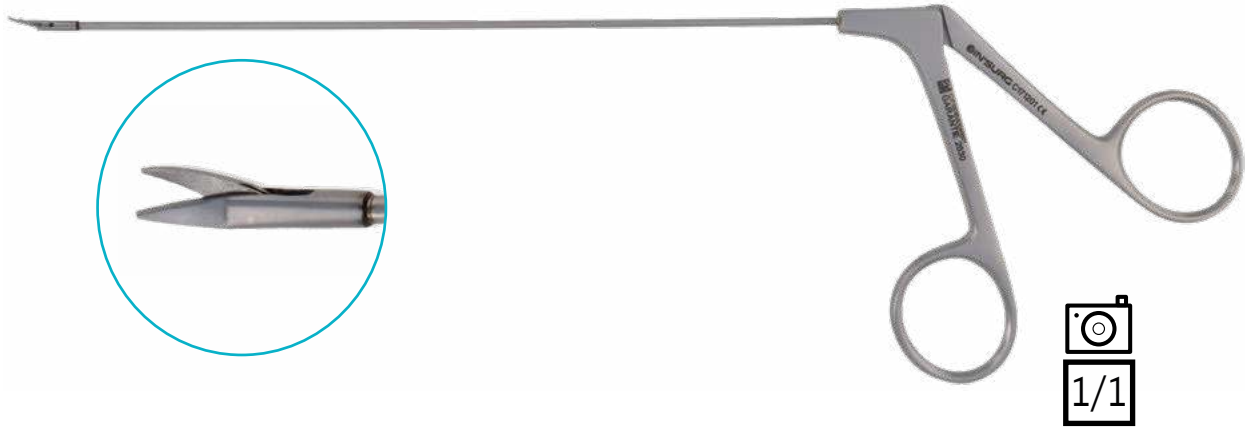

CISEAUX MICRO YASARGIL BAIONNETTE 230 MM COURBE MANCHE TROUE

C171213 YASARGIL MICRO SCISSORS RATCHET 230 MM CURVED HOLE HANDLE



LONGUEUR LENGTH	COURBE CURVED	DROIT STRAIGHT
160 MM	C171209	C171210
200 MM	C171211	C171212
230 MM	C171213	C171214

NEURO SCISSORS

CISEAUX NEURO DANDY 170 MM

C181215 DANDY NEURO SCISSORS 170 MM



CISEAUX NEURO OLIVECRONA 230 MM
TRIJUMEAU

C181217 OLIVECRONA TRIGEMINAL NEURO
SCISSORS 230 MM

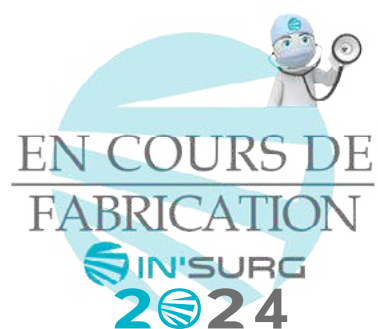

C181216
180 MM

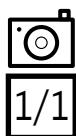

CISEAUX NEURO

NEURO SCISSORS

CISEAUX NEURO SCHMIEDEN 170 MM
C181218 *SCHMIEDEN NEURO SCISSORS 170 MM*

CISEAUX NEURO STRULLY 220 MM COURBE
 BOUTONNE

C181219 *STRULLY NEURO SCISSORS 220 MM
 CURVED BUTTONE*

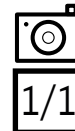
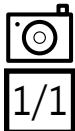
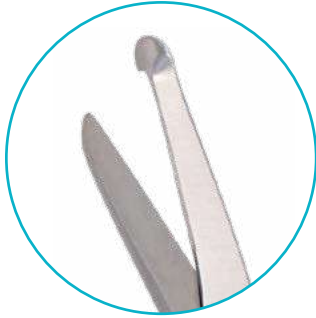

E.N.T SCISSORS

CISEAUX O.R.L 180 MM DROIT CRANTEES

C191223 E.N.T SCISSORS 180 MM
STRAIGHT SERRATED BLADES

CISEAUX O.R.L BOETTCHER 180 MM COURBE

C181220 BOETTCHER E.N.T SCISSORS 180 MM
CURVED



CISEAUX O.R.L

E.N.T SCISSORS

CISEAUX O.R.L BROPHY 145 MM COURBE
C191221 *BROPHY E.N.T SCISSORS 145 MM CURVED*

CISEAUX O.R.L BROPHY 145 MM DROIT
C191222 *BROPHY E.N.T SCISSORS 145 MM STRAIGHT*



CISEAUX O.R.L CHADWICK 115 MM COURBE POINTU
C191224 *CHADWICK E.N.T SCISSORS 115 MM SHARP CURVED*



CISEAUX O.R.L COTTLE 160 MM
C191225 COTTLE E.N.T SCISSORS 160 MM

CISEAUX O.R.L COTTLE 160 MM ULTRA LINE
C191226 ULTRA LINE COTTLE E.N.T SCISSORS 160 MM

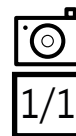
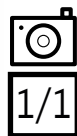
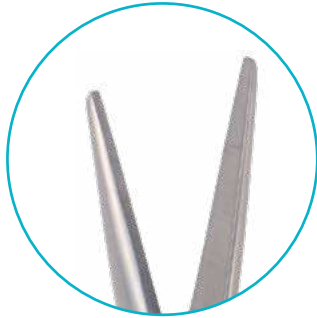

CISEAUX O.R.L

E.N.T SCISSORS

CISEAUX O.R.L DEAN 180 MM
C191227 DEAN E.N.T SCISSORS 180 MM



CISEAUX O.R.L FOMON 140 MM
COURBE POUR RHINOPLASTIE

C191228 FOMON E.N.T SCISSORS 140 MM
CURVED FOR RHINOPLASTY

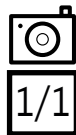

CISEAUX O.R.L FOMON 140 MM
POUR RHINOPLASTIE

C191229 FOMON E.N.T SCISSORS
140 MM FOR RHINOPLASTY

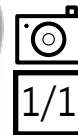
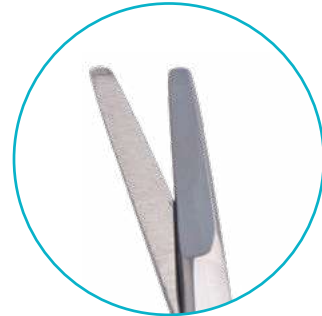

CISEAUX O.R.L

E.N.T SCISSORS

CISEAUX O.R.L FOMON 145 MM
TUNGSTENE POUR RHINOPLASTIE
C191230 FOMON E.N.T SCISSORS
145 MM TUNGSTEN
FOR RHINOPLASTY

CISEAUX O.R.L FOMON 115 MM COURBE
ULTRA LINE
C191231 ULTRA LINE FOMON E.N.T SCISSORS 115 MM
CURVED

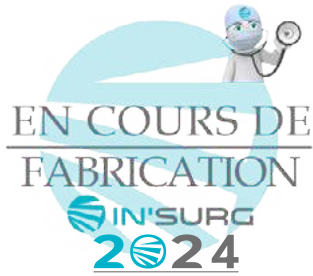

CISEAUX O.R.L FREEMAN 180 MM
COURBE ULTRA LINE

C191232 *ULTRA LINE FREEMAN E.N.T
SCISSORS 180 MM CURVED*

CISEAUX O.R.L FREEMAN KAYE 190 MM
DROIT ULTRA LINE

C191233 *ULTRA LINE FREEMAN KAYE E.N.T
SCISSORS 190 MM STRAIGHT*



CISEAUX O.R.L GOLDMAN FOX 130 MM
COURBE ULTRA LINE

C191234 *ULTRA LINE GOLDMAN FOX E.N.T
SCISSORS 130 MM CURVED*

CISEAUX O.R.L GOLDMAN FOX 130 MM
DROIT ULTRA LINE

C191235 *ULTRA LINE GOLDMAN FOX E.N.T
SCISSORS 130 MM STRAIGHT*

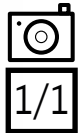

CISEAUX O.R.L GORNEY 230 MM COURBE ULTRA LINE

C191236 *ULTRA LINE GORNEY E.N.T SCISSORS 230 MM CURVED*



CISEAUX O.R.L GREENBERG-RAGNELL 120 MM COURBE ULTRA LINE

C191237 *ULTRA LINE GREENBERG-RAGNELL E.N.T SCISSORS 120 MM CURVED*



C191238
150 MM

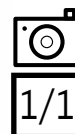
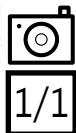

CISEAUX O.R.L

E.N.T SCISSORS

CISEAUX O.R.L JOSEPH 140 MM COURBE
ULTRA LINE

C191239 *ULTRA LINE JOSEPH E.N.T SCISSORS
140 MM CURVED*

CISEAUX O.R.L JOSEPH 140 MM DROIT
ULTRA LINE

C191240 *ULTRA LINE JOSEPH E.N.T SCISSORS
140 MM STRAIGHT*



CISEAUX O.R.L KAYE LIFT 190 MM COURBE ULTRA LINE
C191242 *ULTRA LINE KAYE LIFT E.N.T SCISSORS 190 MM CURVED*



C191241
150 MM

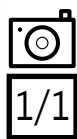

CISEAUX O.R.L GOLDMAN FOX 130 MM DROIT LAMES CRANTEES TUNGSTENE
C191249 GOLDMAN FOX E.N.T SCISSORS 130 MM STRAIGHT SERRATED BLADES TUNGSTEN

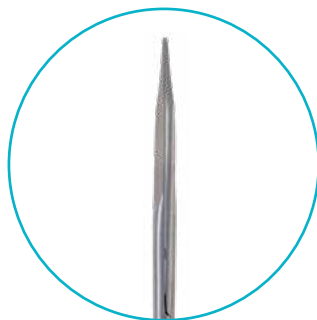
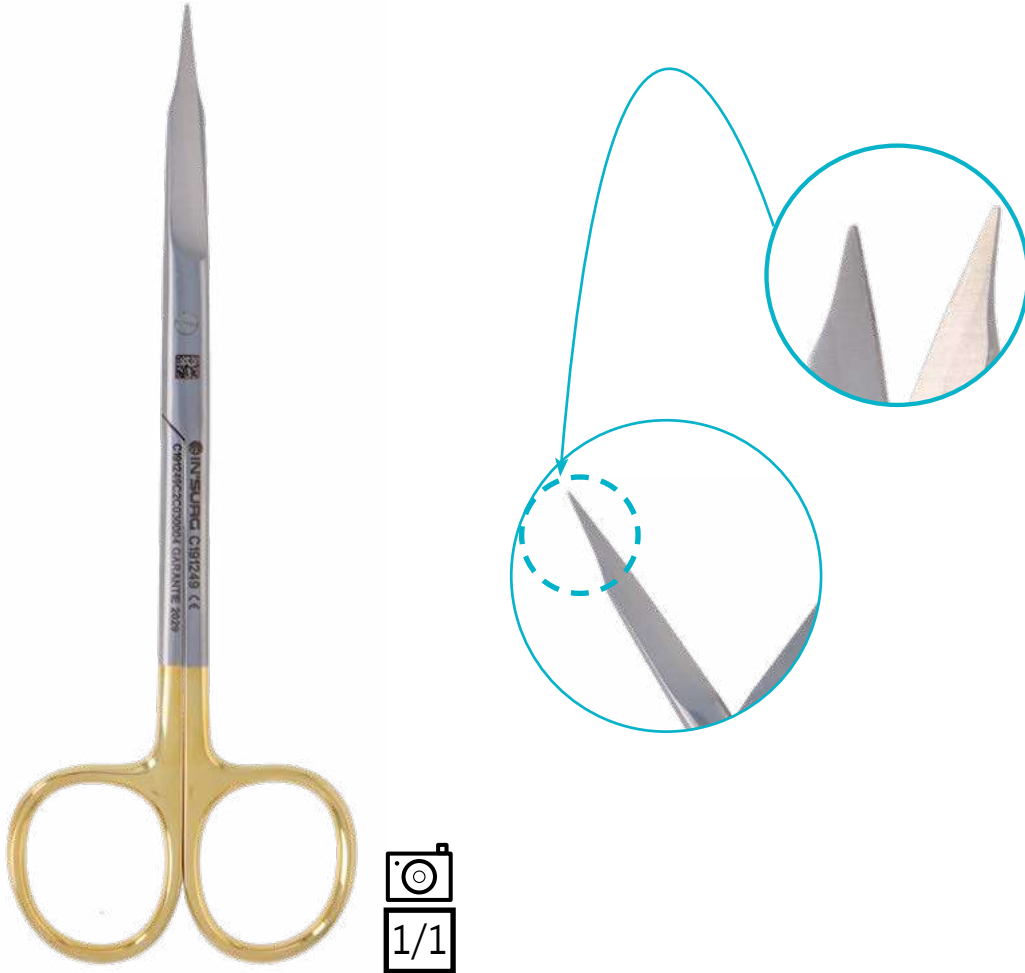

DROIT
STRAIGHT



COURBE
CURVED



ANGULE
ANGULATED

LONGUEUR
LENGTH

130 MM

C191249

C191246

C191244

CISEAUX O.R.L GOLDMAN FOX 130 MM
COURBE LAMES CRANTEES

C191245 *GOLDMAN FOX E.N.T SCISSORS 130
MM CURVED SERRATED BLADES*



CISEAUX O.R.L GOLDMAN FOX 130 MM
DROIT LAMES CRANTEES

C191248 *GOLDMAN FOX E.N.T SCISSORS
130 MM STRAIGHT SERRATED
BLADES*



CISEAUX O.R.L GOLDMAN FOX 130 MM DROIT 1 LAME CRANTEE POINTUE TUNGSTENE

C191250 *GOLDMAN FOX E.N.T SCISSORS 130 MM STRAIGHT 1 SERRATED BLADE SHARP TUNGSTEN*

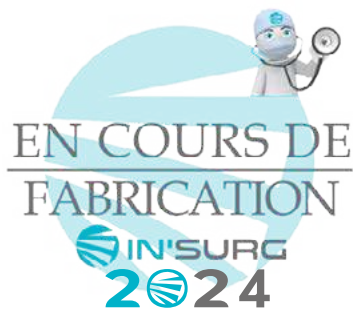

CISEAUX O.R.L

E.N.T SCISSORS

CISEAUX O.R.L GORNEY 190 MM COURBE

C191251 GORNEY E.N.T SCISSORS 190 MM CURVED

CISEAUX O.R.L GORNEY 200 MM DROIT

C191252 GORNEY E.N.T SCISSORS 200 MM STRAIGHT

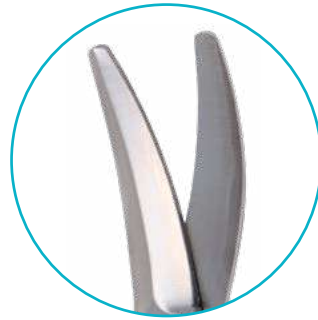

Également disponible en Tungstène

- Robustesse de la lame
- Permet d'effectuer plus de 600 coupes

CISEAUX O.R.L GORNEY 200 MM DROIT TUNGSTENE

C191254 GORNEY E.N.T SCISSORS 200 MM STRAIGHT TUNGSTEN

CISEAUX O.R.L GORNEY 200 MM COURBE TUNGSTENE

C191253 GORNEY E.N.T SCISSORS 200 MM CURVED TUNGSTEN

CISEAUX O.R.L GRAEFE 105 MM COURBE BOUTONNE
C191255 *GRAEFE E.N.T SCISSORS 105 MM BUTTONE CURVED*



LONGUEUR LENGTH	COURBE CURVED	DROIT STRAIGHT
105 MM	C191255	C191256

CISEAUX O.R.L GRAEFE 115 MM COUDE POINTU
C191258 *GRAEFE E.N.T SCISSORS 115 MM SHARP ANGLED*



LONGUEUR LENGTH	MOUSSE BLUNT	POINTU SHARP
115 MM	C191257	C191258

CISEAUX O.R.L

E.N.T SCISSORS

CISEAUX O.R.L HEYMANN 180 MM
COUDE LAMES CRANTEES

C191259 *HAYMANN E.N.T SCISSORS
180 MM ANGLED SERRATED
BLADES*

CISEAUX O.R.L LOCKLIN 160 MM COUDE

C191265 *LOCKLIN E.N.T SCISSORS 160 MM
ANGLED*

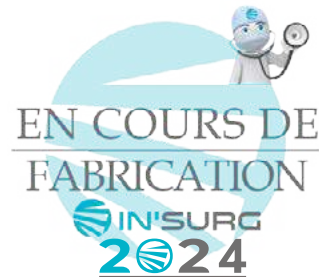

CISEAUX O.R.L JOSEPH 140 MM COURBE
C191260 JOSEPH E.N.T SCISSORS 140 MM CURVED

CISEAUX O.R.L JOSEPH 140 MM DROIT
C191261 JOSEPH E.N.T SCISSORS 140 MM STRAIGHT

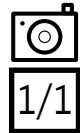
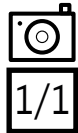

CISEAUX O.R.L LAGRANGE 115 MM LAMES CRANTEES EN S
C191264 LAGRANGE E.N.T SCISSORS 115 MM SERRATED BLADES S FORM

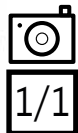

CISEAUX O.R.L

E.N.T SCISSORS

CISEAUX O.R.L KELLY 180 MM COURBE

C191284 KELLY E.N.T SCISSORS 180 MM
CURVED

CISEAUX O.R.L KELLY 180 MM DROIT

C191285 KELLY E.N.T SCISSORS 180 MM STRAIGHT



C191262
160 MM



C191263
160 MM



CISEAUX O.R.L RAGNELL KILNER 180 MM
COURBE ULTRA LINE

C191273 *ULTRA LINE RAGNELL KILNER E.N.T
SCISSORS 180 MM CURVED*



Garantie
totale
10 ANS
sans conditions

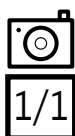

CISEAUX O.R.L RAGNELL KILNER 120 MM
COURBE TUNGSTENE

C191266 *RAGNELL KILNER E.N.T SCISSORS
120 MM CURVED TUNGSTEN*



C191270
150 MM

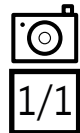

CISEAUX O.R.L

E.N.T SCISSORS

CISEAUX O.R.L RAGNELL KILNER 125 MM
COURBE

C191267 *RAGNELL KILNER E.N.T SCISSORS
125 MM CURVED*

CISEAUX O.R.L RAGNELL KILNER 125 MM
DROIT

C191268 *RAGNELL KILNER E.N.T SCISSORS
125 MM STRAIGHT*

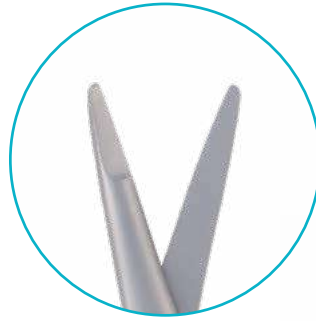

C191269
150 MM

C191271
180 MM

C191272
200 MM

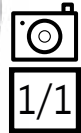
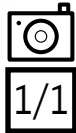

CISEAUX O.R.L REYNOLDS 145 MM COURBE
C191274 REYNOLDS E.N.T SCISSORS 145 MM
CURVED

CISEAUX O.R.L REYNOLDS 160 MM COURBE
ULTRA LINE
C191275 ULTRA LINE REYNOLDS E.N.T SCISSORS
160 MM CURVED



Garantie
totale
10 ANS
sans conditions



CISEAUX O.R.L

E.N.T SCISSORS

CISEAUX O.R.L STEVENS 105 MM COURBE POINTU

C191279 *STEVENS E.N.T SCISSORS 105 MM SHARP CURVED*



LONGUEUR
LENGTH

105 MM

110 MM

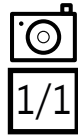

COURBE
CURVED

DROIT
STRAIGHT

C191279

C191280

CISEAUX O.R.L STEVENS 110 MM DROIT MOUSSE

C191278 *STEVENS E.N.T SCISSORS 110 MM BLUNT STRAIGHT*



LONGUEUR
LENGTH

110 MM

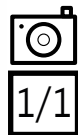

COURBE
CURVED

DROIT
STRAIGHT

C191277

C191278

CISEAUX O.R.L STREIFF 110 MM DROIT
MODELE FIN

C191281 STREIFF E.N.T SCISSORS 110 MM
STRAIGHT BENT



CISEAUX O.R.L STREIFF 115 MM DROIT

C191282 STREIFF E.N.T SCISSORS 115 MM
STRAIGHT



CISEAUX O.R.L SHEA 115 MM COURBE

C191276 SHEA SCISSORS 115 MM CURVED

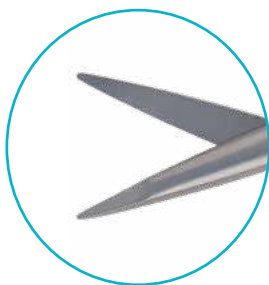



Garantie
totale
5 ANS
sans conditions

CISEAUX 140 MM DROIT ONGLES INCARNES

C201284 *SCISSORS 140 MM STRAIGHT FOR INGROWN TOENAIL*

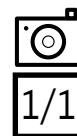
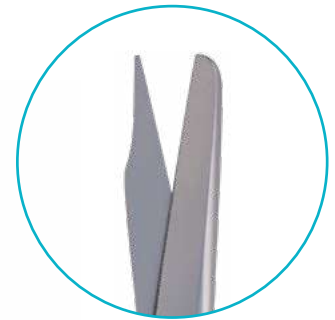

BANDAGE SCISSORS

CISEAUX 160 MM LAMES CRANTEES
PANSEMENT BANDAGE

C201285 *BANDAGE- PLASTER SCISSORS
160 MM SERRATED BLADES*



CISEAUX BERGMANN 230 MM COUDE

C201286 *BERGMANN SCISSORS 230 MM
ANGLED*

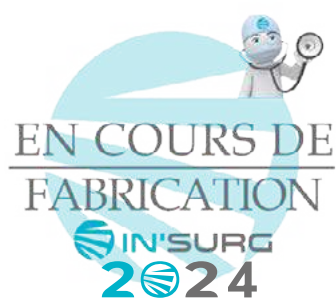

CISEAUX PANSEMENT

BANDAGE SCISSORS

CISEAUX LISTER 140 MM
PANSEMENT PLATRE

C201290 *LISTER BANDAGE- PLASTER
SCISSORS 140 MM*

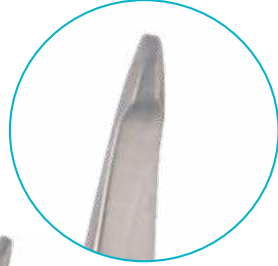

C201291
180 MM

C201292
200 MM

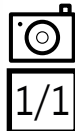

CISEAUX KNOWLES 140 MM COUDE

C201287 *KNOWLES SCISSORS 140 MM
ANGLED*

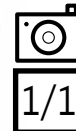



CISEAUX BRUNS 230 MM
LAMES CRANTEES

C201288 BRUNS SCISSORS 230 MM
SERRATED BLADE



CISEAUX BRUNS 240 MM
LAMES LISSES

C201289 BRUNS SCISSORS
240 MM SMOOTH BLADES



CISEAUX UNIVERSEL 180 MM PANSEMENT PLATRE ANNEAUX PLASTIQUES

C201294 *UNIVERSAL BANDAGE- PLASTER SCISSORS 180 MM PLASTIC RINGS*

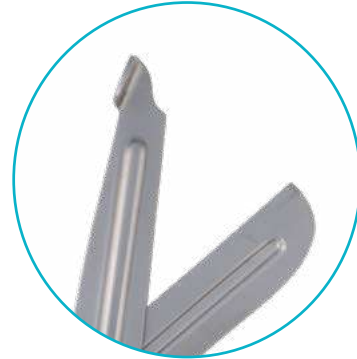

C201293
150 MM

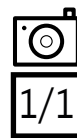

CISEAUX RECTUM

www.in-surg.fr



RECTUM SCISSORS

CISEAUX 260 MM COUDE A 80° POUR RECTUM

C211295 *SCISSORS 260 MM ANGLED 80° FOR RECTUM*



IN/SURG C211295 € €
C211295/12050001 GARANTIE 2030



CISEAUX VASCULAIRE DIETRICH 180 MM
COUDE A 125° ULTRA LINE

C221304 *ULTRA LINE DIETRICH VASCULAR SCISSORS
180 MM ANGLED 125°*

**Garantie
totale
10 ANS**
sans conditions



COUDE A 125°
ANGLED 125°

C221304



COUDE A 25°
ANGLED 25°

C221296



COUDE A 45°
ANGLED 45°

C221298



COUDE A 60°
ANGLED 60°

C221300



COUDE A 90°
ANGLED 90°

C221302

CISEAUX VASCULAIRE DIETRICH 180 MM LAMES COURTES COUDE A 25° ULTRA LINE

C221297 *ULTRA LINE DIETRICH VASCULAR SCISSORS 180 MM ANGLED 25° SHORT BLADES*



Garantie totale
10 ANS
sans conditions



COUDE A 25°
ANGLED 25°

C221297

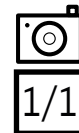

COUDE A 45°
ANGLED 45°

C221299



COUDE A 60°
ANGLED 60°

C221301



COUDE A 90°
ANGLED 90°

C221303



COUDE A 125°
ANGLED 25°

C221305

CISEAUX VASCULAIRE DIETRICH 190 MM
LAMES MICRO COUDE A 125° ULTRA LINE

C221310 *ULTRA LINE DIETRICH VASCULAR SCISSORS 190 MM
ANGLED 125° MICRO BLADES*

**Garantie totale
10 ANS**
sans conditions



COUDE A 125°
ANGLED 125°

C221310



COUDE A 25°
ANGLED 25°

C221306



COUDE A 45°
ANGLED 45°

C221307



COUDE A 60°
ANGLED 60°

C221308



COUDE A 90°
ANGLED 90°

C221309

CISEAUX VASCULAIRE CRAFOORD 315 MM
COURBE

C221311 CRAFOORD VASCULAR SCISSORS
315 MM CURVED



CISEAUX VASCULAIRE DEBAKEY 170 MM
CONTRE COUDE

C221318 DEBAKEY VASCULAR SCISSORS
170 MM COUNTER ELBOW



CISEAUX VASCULAIRE DEBAKEY 160 MM COUDE A 45°

C221314 DEBAKEY VASCULAR SCISSORS 160 MM ANGLED 45°

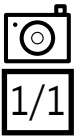

COUDE 25°
ANGLED 25°



COUDE 45°
ANGLED 45°



COUDE 60°
ANGLED 60°

LONGUEUR
LENGTH

160 MM

C221314

170 MM

C221312

C221316

230 MM

C221319

C221321

C221323

280 MM

C221325

C221327

C221329

CISEAUX VASCULAIRE DEBAKEY 170 MM COUDE A 60° TUNGSTENE

C221317 DEBAKEY VASCULAR SCISSORS 170 MM ANGLED 60° TUNGSTEN



COUDE 25°
ANGLED 25°



COUDE 45°
ANGLED 45°



COUDE 60°
ANGLED 60°

LONGUEUR
LENGTH

160 MM

C221313

C221315

170 MM

C221317

230 MM

C221320

C221322

C221324

CISEAUX VASCULAIRE DIETRICH 180 MM COUDE A 125° FIN

C221339 *DIETRICH BENT VASCULAR SCISSORS 180 MM ANGLED 125° BENT*



COUDE A 25°
ANGLED 25°

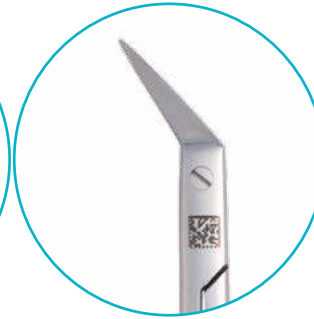

COUDE A 45°
ANGLED 45°



COUDE A 60°
ANGLED 60°

LONGUEUR
LENGTH

135 MM

C221331

C221332

C221333

180 MM

C221335

C221336

C221337



COUDE A 90°
ANGLED 90°



COUDE A 125°
ANGLED 125°

LONGUEUR
LENGTH

135 MM

C221334

C221339

180 MM

C221338

CISEAUX VASCULAIRE POTTS-MARTEL 190 MM COUDE A 25°

C221343 *POTTS-MARTEL VASCULAR SCISSORS 190 MM ANGLED 25°*



COUDE A 25°
ANGLED 25°

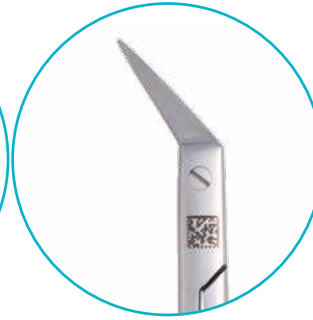

COUDE A 45°
ANGLED 45°



COUDE A 60°
ANGLED 60°

LONGUEUR
LENGTH

190 MM

C221343

C221345

C221347

CISEAUX VASCULAIRE POTTS-MARTEL TUNGSTENE

POTTS-MARTEL VASCULAR SCISSORS TUNGSTEN

LONGUEUR
LENGTH

190 MM

COUDE A 25°
ANGLED 25°

C221344

COUDE A 45°
ANGLED 45°

C221346

COUDE A 60°
ANGLED 60°

C221348

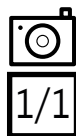

CISEAUX VASCULAIRE

VASCULAR SCISSORS

CISEAUX VASCULAIRE SATINSKY 240 MM EN S
C221349 SATINSKY VASCULAR SCISSORS 240 MM S FORM

CISEAUX VASCULAIRE THOREK 185 MM
 TRES COURBE
C221350 THOREK VASCULAR SCISSORS
 185 MM VERY CURVED



C221351
 250 MM

CISEAUX VASCULAIRE KLIKENBERG
 230 MM COURBE EN FORME DE S
C221352 KLIKENBERG VASCULAR
 SCISSORS 230 MM CURVED S FORM

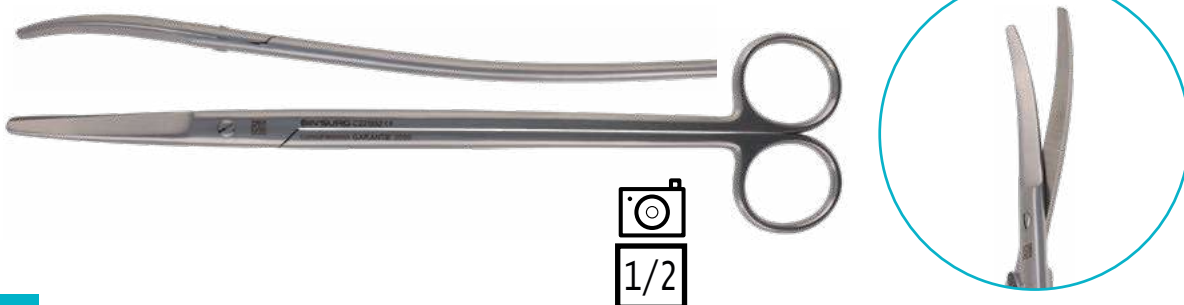

CLAMP BAR

CLAMP STEEL

LE CLAMP BAR CORDON OMBILICAL est utilisé pour fermer le cordon ombilical du nouveau-né afin de permettre au praticien de le couper

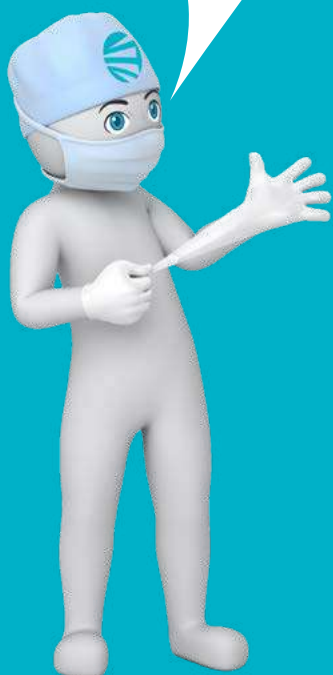

CLAMP BAR CORDON OMBILICAL

C231353 *UMBILICAL CLAMP STEEL*

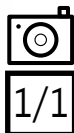

CLAMP BULLDOG

BULLDOG CLAMP

CLAMP BULLDOG FIN

BULLDOG CLAMP BENT



LONGUEUR
LENGTH

35 MM

COURBE
CURVED

C241354

DROIT
STRAIGHT

C241355

40 MM

C241356

C241357

50 MM

C241358

C241359

60 MM

C241360

C241361

70 MM

C241362

C241363

CLAMP BULLDOG 70 MM COURBE FIN

C241362 BULLDOG CLAMP 70 MM CURVED BENT

CLAMP BULLDOG FORT

BULLDOG CLAMP STRONG



LONGUEUR
LENGTH

35 MM

COURBE
CURVED

C241364

DROIT
STRAIGHT

C241365

40 MM

C241366

C241367

50 MM

C241368

C241369

60 MM

C241370

C241371

70 MM

C241372

C241373

CLAMP BULLDOG 60 MM COURBE FORT

C241370 BULLDOG CLAMP 60 MM CURVED STRONG

CLAMP BULLDOG MINI 16 X 55 MM COUDE

C241376 BULLDOG MINI CLAMP 16 X 55 MM ANGLED

CLAMP BULLDOG MINI 16 X 60 MM DROIT

C241379 BULLDOG MINI CLAMP 16 X 60 MM STRAIGHT



C241374
8 X 45 MM

C241375
12 X 45 MM



C241377
8 X 50 MM

C241378
12 X 50 MM

CLAMP BULLDOG DEBAKEY MICRO 20 X 57 MM COUDE

C241389 BULLDOG MICRO DEBAKEY CLAMP 20 X 57 MM ANGLED

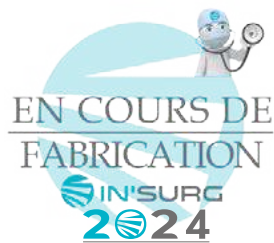

CLAMP BULLDOG

BULLDOG CLAMP

CLAMP BULLDOG DEBAKEY 20 X 80 MM
DROIT

C231384 BULLDOG DEBAKEY CLAMP 20 X 80 MM
STRAIGHT



C241385
30 X 90 MM

C241386
45 X 105 MM

C241387
68 X 125 MM

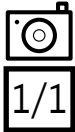

CLAMP BULLDOG DEBAKEY 20 X 75 MM
COURBE

C241380 BULLDOG DEBAKEY CLAMP
20 X 75 MM CURVED



C241381
30 X 80 MM

C241382
45 X 95 MM

C241383
68 X 115 MM



CLAMP BULLDOG DEBAKEY MICRO 18 X 60 MM
DROIT

C241390 BULLDOG MICRO DEBAKEY CLAMP
18 X 60 MM STRAIGHT

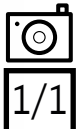

CLAMP BULLDOG DEBAKEY MICRO
18 X 56 MM COURBE

C241388 BULLDOG MICRO DEBAKEY CLAMP
18 X 56 MM CURVED

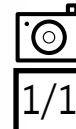

CLAMP BULLDOG GLOVER 45 X 90 MM DROIT

C241395 BULLDOG GLOVER CLAMP 45 X 90 MM STRAIGHT



C241394
30 X 70 MM

C241396
56 X 105 MM

CLAMP BULLDOG GLOVER 30 X 60 MM COURBE

C241391 BULLDOG GLOVER CLAMP 30 X 60 MM CURVED



C241392
43 X 85 MM

C241393
56 X 100 MM

CLAMP BULLDOG GLOVER MICRO 14 X 35 MM DROIT

C241397 BULLDOG MICRO GLOVER CLAMP 14 X 35 MM STRAIGHT

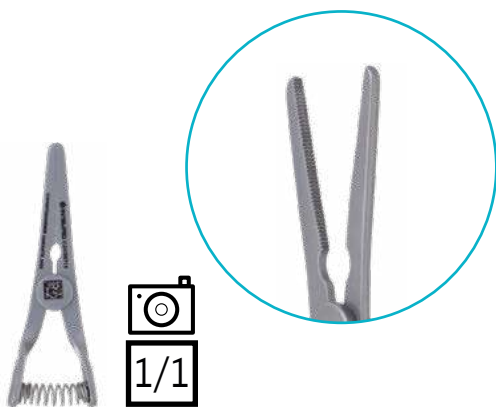

CLAMP BULLDOG GLOVER MICRO 14 X 30 MM COURBE

C241398 BULLDOG MICRO GLOVER CLAMP 14 X 30 MM CURVED

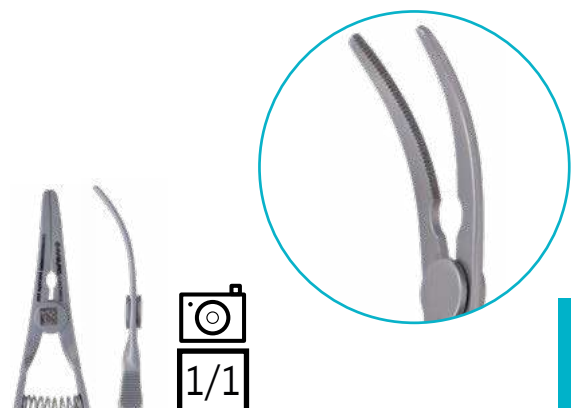

CLAMP BULLDOG

BULLDOG CLAMP

CLAMP BULLDOG GREGORY
70 X 120 MM COUDE

C241399 BULLDOG GREGORY CLAMP
70 X 120 MM ANGLED



PINCE A POSER PR CLAMP BULLDOG J.HOPKINS
230 MM

C241400 APPLYING FORCEPS FOR BULLDOG J.HOPKINS
CLAMP 230 MM



CLAMP BULLDOG SANTULLI 30 X 70 MM
COUDE A 90°

C241401 BULLDOG SANTULLI CLAMP
30 X 70 MM ANGLED 90°



CLAMP DIGESTIF

www.in-surg.fr



DIGESTIVE CLAMP

CLAMP DIGESTIF BAINBRIDGE 150 MM COURBE

C251403 BAINBRIDGE INTESTINAL CLAMP 150 MM CURVED

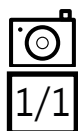

COURBE
CURVED



DROIT
STRAIGHT

LONGUEUR
LENGTH

150 MM

C251403

C251404

185 MM

C251405

C251406

CLAMP DIGESTIF

DIGESTIVE CLAMP

CLAMP DIGESTIF BEST 250 MM
GRAND MODELE

C251407 *BEST DIGESTIVE CLAMP 250 MM
LARGE MODEL*

C251408
250 MM - PETIT MODELE
SMALL MODEL



CLAMP DIGESTIF BRUNNER 240 MM BAIONNETTE
C251409 BRUNNER DIGESTIVE CLAMP 240 MM BAYONET

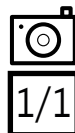
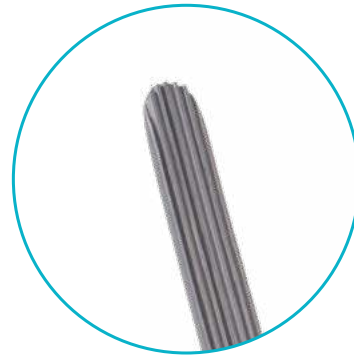

CLAMP DIGESTIF

DIGESTIVE CLAMP

CLAMP DIGESTIF DOYEN 180 MM COURBE
C251410 DOYEN DIGESTIVE CLAMP 180 MM CURVED



C251410
180 MM



C251412
210 MM



C251414
230 MM



CLAMP DIGESTIF DOYEN 180 MM DROIT

C251411 *DOYEN DIGESTIVE CLAMP 180 MM STRAIGHT*



C251411
180 MM



C251413
210 MM



C251415
230 MM

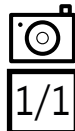



CLAMP DIGESTIF

DIGESTIVE CLAMP

CLAMP DIGESTIF DOYEN 180 MM COURBE ATRAUMATIQUE

C251418 DOYEN ATRAUMATIC DIGESTIVE CLAMP 180 MM CURVED



C251416
130 MM

C251418
180 MM

C251420
210 MM

C251422
230 MM

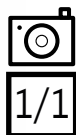

CLAMP DIGESTIF DOYEN 180 MM DROIT ATRAUMATIQUE

C251419 *DOYEN ATRAUMATIC DIGESTIVE CLAMP 180 MM STRAIGHT*

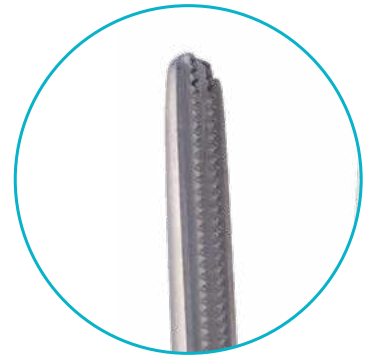

C251417
130 MM

C251419
180 MM

C251421
210 MM

C251423
230 MM

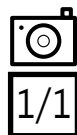

CLAMP DIGESTIF

DIGESTIVE CLAMP

CLAMP DIGESTIF DOYEN 250 MM
COURBE MORS STRIES SUR LONGUEUR

C251424 *DOYEN DIGESTIVE CLAMP 250 MM
CURVED JAWS WITH STRIATIONS
ALONG THE LENGTH*

CLAMP DIGESTIF DOYEN 250 MM DROIT
MORS STRIES SUR LONGUEUR

C251425 *DOYEN DIGESTIVE CLAMP 250 MM
STRAIGHT JAWS WITH STRIATIONS
ALONG THE LENGTH*



CLAMP DIGESTIF FEHLAND
240 MM COUDE A 90°

C251426 FEHLAND DIGESTIVE CLAMP 240 MM
ANGLED 90°



CLAMP DIGESTIF FEHLAND 240 MM COUDE A 90°
ATRAUMATIQUE

C251427 FEHLAND ATRAUMATIC DIGESTIVE CLAMP
240 MM ANGLED 90°

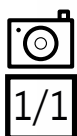

CLAMP DIGESTIF
DIGESTIVE CLAMP

CLAMP DIGESTIF FERGUSON 160 MM COURBE HEMORROIDES
C251428 *FERGUSON DIGESTIVE CLAMP 160 MM CURVED HEMORRHOIDS*

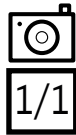

COURBE
CURVED



DROIT
STRAIGHT

LONGUEUR
LENGTH

160 MM

C251428

C251430

200 MM

C251429

C251431

CLAMP DIGESTIF GOULLOUD 230 MM TRES COURBE

C251433 *GOULLOUD ATRAUMATIC DIGESTIVE CLAMP 230 MM VERY CURVED*



C251434
210 MM TRES COURBE
VERY CURVED





CLAMP DIGESTIF

DIGESTIVE CLAMP

CLAMP DIGESTIF HAYES
70 X 280 MM
ATRAUMATIQUE

C251436 HAYES ATRAUMATIC
DIGESTIVE CLAMP
70 X 280 MM



C251435
55 X 260 MM



CLAMP DIGESTIF KOCHER 220 MM COURBE

C251438 KOCHER DIGESTIVE CLAMP 220 MM CURVED



C251438
220 MM



C251440
250 MM



C251442
280 MM

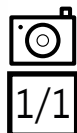



CLAMP DIGESTIF

DIGESTIVE CLAMP

CLAMP DIGESTIF KOCHER 250 MM DROIT

C251441 KOCHER DIGESTIVE CLAMP 250 MM STRAIGHT

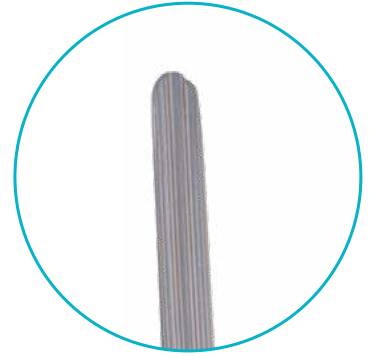

C251439
220 MM

C251441
250 MM

C251443
280 MM

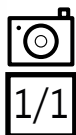

CLAMP DIGESTIF KOCHER 230 MM COURBE ATRAUMATIQUE
C251444 KOCHER ATRAUMATIC DIGESTIVE CLAMP 230 MM CURVED

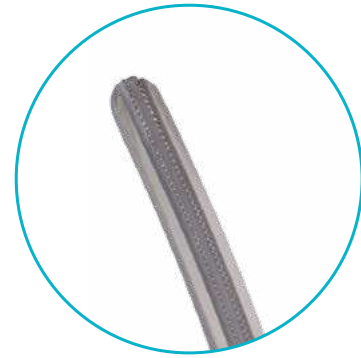

C251444
230 MM



C251446
250 MM



C251448
270 MM

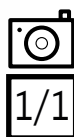



CLAMP DIGESTIF

DIGESTIVE CLAMP

CLAMP DIGESTIF KOCHER 230 MM DROIT ATRAUMATIQUE

C251445 KOCHER ATRAUMATIC DIGESTIVE CLAMP 230 MM STRAIGHT

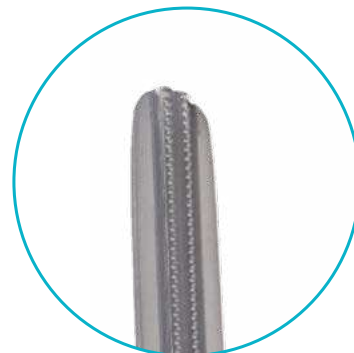

C251445
230 MM

C251447
250 MM

C251449
270 MM

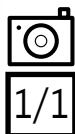

CLAMP DIGESTIF LANE 310 MM COURBE
C251450 LANE DIGESTIVE CLAMP 310 MM CURVED

CLAMP DIGESTIF LANE 310 MM DROIT
C251451 LANE DIGESTIVE CLAMP 310 MM STRAIGHT





CLAMP DIGESTIF

DIGESTIVE CLAMP

CLAMP DIGESTIF WERTHEIM CULLEN 215 MM

C251458 WERTHEIM CULLEN DIGESTIVE CLAMP 215 MM

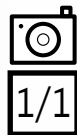
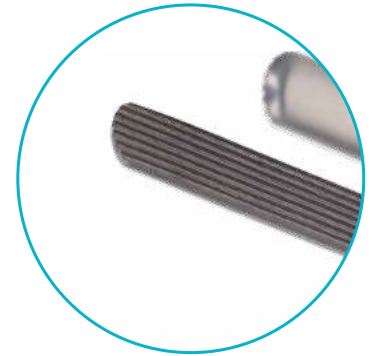

CLAMP DIGESTIF RICHELOT 220 MM COURBE A DOIGT

C251455 *RICHELOT DIGESTIVE CLAMP 220 MM CURVED DISMOUNTABLE*

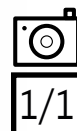
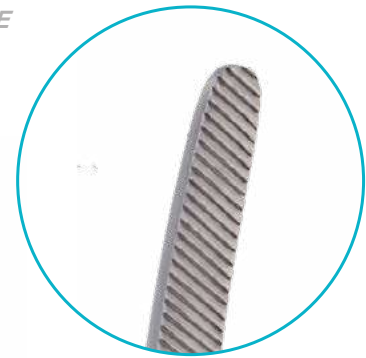

CLAMP DIGESTIF

DIGESTIVE CLAMP

CLAMP DIGESTIF SCUDDER 320 MM
DROIT ATRAUMATIQUE

C251457 SCUDDER ATRAUMATIC
DIGESTIVE CLAMP 320 MM
STRAIGHT

CLAMP DIGESTIF SCUDDER 320 MM
COURBE ATRAUMATIQUE

C251456 SCUDDER ATRAUMATIC
DIGESTIVE CLAMP 320 MM
CURVED

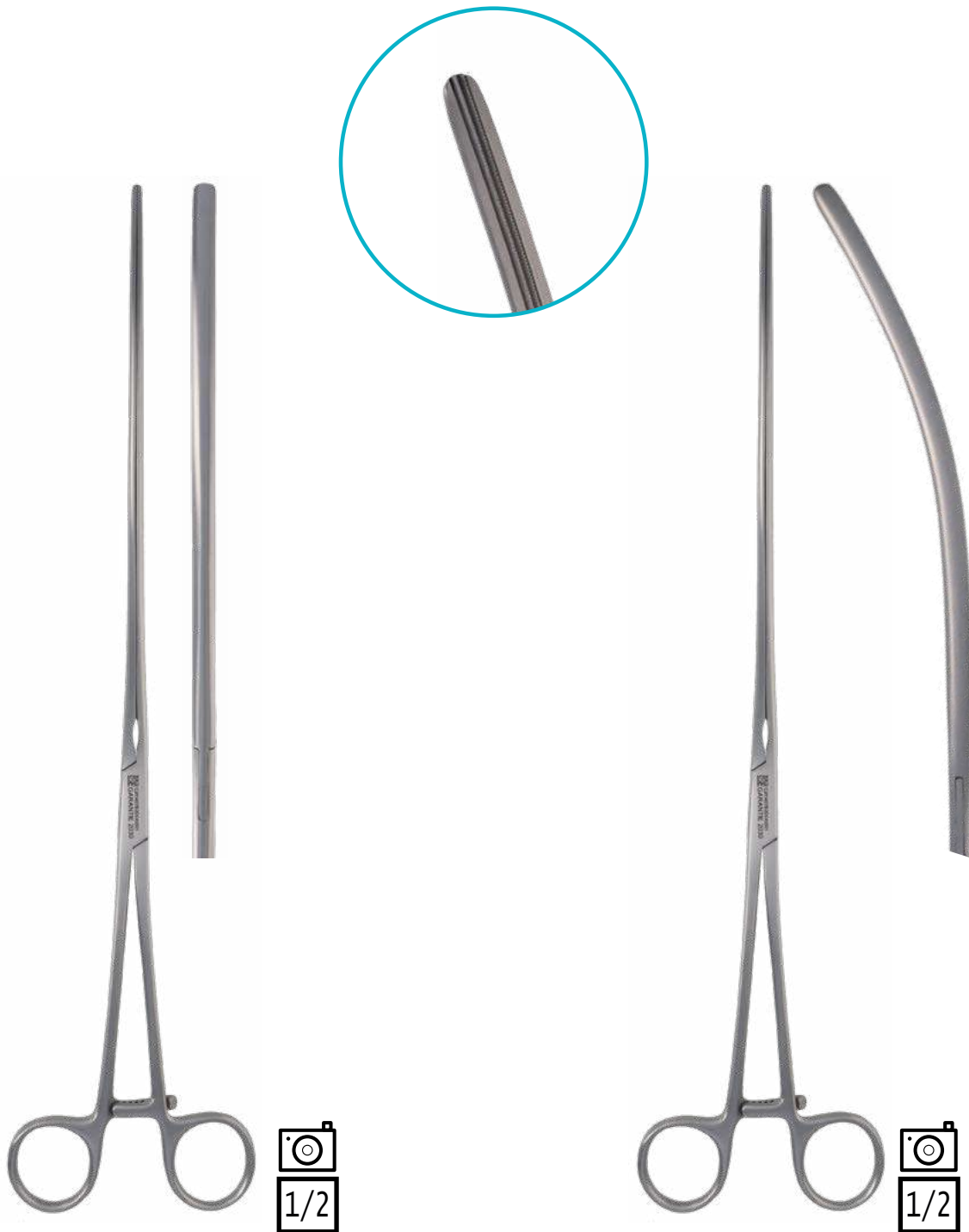

CLAMP VASCULAIRE ANASTOMOSE ANASTOMOSIS VASCULAR CLAMP

www.in-surg.fr



CLAMP VASCULAIRE BECK 170 MM
ANASTOMOSE MORS COOLEY

C261462 *BECK VASCULAR CLAMP
170 MM JAWS COOLEY ANASTOMOSIS*

CLAMP VASCULAIRE BECK 178 MM
ANASTOMOSE MORS DEBAKEY

C261463 *BECK VASCULAR CLAMP
178 MM JAWS DEBAKEY ANASTOMOSIS*

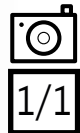



CLAMP VASCULAIRE ANASTOMOSE *ANASTOMOSIS VASCULAR CLAMP*

CLAMP VASCULAIRE 175 MM ANASTOMOSE MORS COOLEY
C261464 *VASCULAR CLAMP 175 MM JAWS COOLEY ANASTOMOSIS*



CLAMP VASCULAIRE DERRA 180 MM ANASTOMOSE
MORS COOLEY PETIT MODELE

C261467 DERRA VASCULAR CLAMP 180 MM ANASTOMOSIS
JAWS COOLEY SMALL SIZE



PETIT MODELE **C261467**
SMALL SIZE



MOYEN MODELE **C261466**
MEDIUM SIZE



GRAND MODELE **C261465**
LARGE SIZE

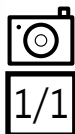



CLAMP VASCULAIRE ANASTOMOSE

ANASTOMOSIS VASCULAR CLAMP

CLAMP VASCULAIRE DERRA 160 MM ANASTOMOSE
 MORS DEBAKEY PETIT MODELE
C261470 DERRA VASCULAR CLAMP 160 MM ANASTOMOSIS
 JAWS DEBAKEY SMALL SIZE

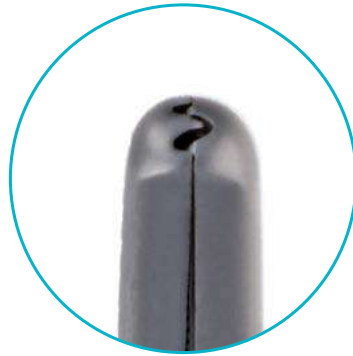

PETIT MODELE **C261470**
SMALL SIZE
 160 MM



MOYEN MODELE **C261469**
MEDIUM SIZE
 170 MM



GRAND MODELE **C261468**
LARGE SIZE
 180 MM

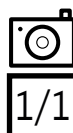

CLAMP VASCULAIRE AORTIQUE

AORTIC VASCULAR CLAMP

www.in-surg.fr



CLAMP VASCULAIRE DIETRICH 210 MM AORTIQUE

C261471 DIETRICH VASCULAR CLAMP 210 MM AORTIC

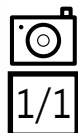



CLAMP VASCULAIRE AORTIQUE

AORTIC VASCULAR CLAMP

CLAMP VASCULAIRE LAMBERT-KAY 210 MM AORTIQUE
C261477 LAMBERT-KAY VASCULAR CLAMP 210 MM AORTIC



C261477
210 MM



C261478
220 MM

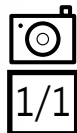

CLAMP VASCULAIRE LEMOLE 205 MM BRANCHES COUDEES AORTIQUE

C261479 LEMOLE VASCULAR CLAMP 205 MM ARMS ANGLED AORTIC



CLAMP VASCULAIRE AORTIQUE

AORTIC VASCULAR CLAMP



CLAMP VASCULAIRE LIDDLE 50 X 265 MM
AORTIQUE

C261480 LIDDLE VASCULAR CLAMP 50 X 265 MM
AORTIC

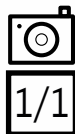

CLAMP VASCULAIRE MORRIS 230 MM AORTIQUE
C261483 MORRIS VASCULAR CLAMP 230 MM AORTIC

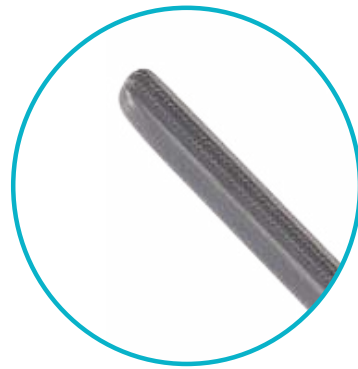

C261481
180 MM



C261482
200 MM



C261483
230 MM

C261484
250 MM

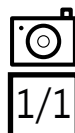



CLAMP VASCULAIRE AORTIQUE

AORTIC VASCULAR CLAMP

CLAMP VASCULAIRE WYLIE 240 MM AORTIQUE ABDOMINAL
C261485 WYLIE CLAMP VASCULAR 240 MM AORTIC ABDOMINAL

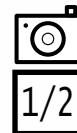

CLAMP VASCULAIRE WYLIE 240 MM AORTIQUE HYPOGASTRIQUE
C261486 WYLIE CLAMP VASCULAR 240 MM AORTIC HYPO GASTRIC

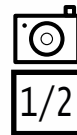



CLAMP VASCULAIRE AORTIQUE

AORTIC VASCULAR CLAMP

CLAMP VASCULAIRE 195 MM AORTIQUE - EXCLUSION
C261487 VASCULAR CLAMP 195 MM AORTIC - EXCLUSION

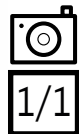

C261488
260 MM



CLAMP VASCULAIRE DEBAKEY 240 MM AORTIQUE - EXCLUSION
C261489 DEBAKEY CLAMP VASCULAR 240 MM AORTIC - EXCLUSION

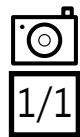



CLAMP VASCULAIRE AORTIQUE

AORTIC VASCULAR CLAMP

CLAMP VASCULAIRE OCHSNER 235 MM AORTIQUE
C261492 OCHSNER VASCULAR CLAMP 235 MM AORTIC



CLAMP VASCULAIRE 270 MM AORTIQUE - EXCLUSION

C261490 CLAMP VASCULAR 270 MM AORTIC - EXCLUSION





IN'SURG

CLAMP VASCULAIRE AORTIQUE AORTIC VASCULAR CLAMP

CLAMP VASCULAIRE WEBER 260 MM COUDE A GAUCHE AORTIQUE
C261494 *WEBER VASCULAR CLAMP 260 MM LEFT ANGLED AORTIC*

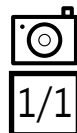

CLAMP VASCULAIRE WEBER 260 MM COUDE A DROITE AORTIQUE

C261493 *WEBER VASCULAR CLAMP 260 MM RIGHT ANGLED AORTIC*

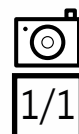



CLAMP VASCULAIRE AORTIQUE

AORTIC VASCULAR CLAMP

CLAMP VASCULAIRE DEBAKEY 260 MM AORTIQUE ANÉVRISME
C261496 DEBAKEY CLAMP VASCULAR 260 MM AORTIC ANEURYSM

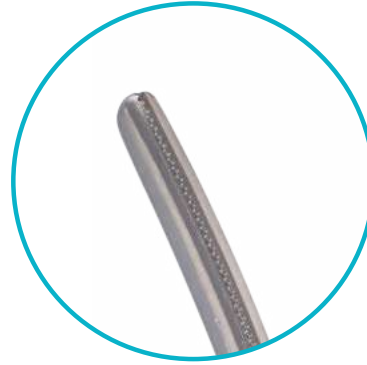

C261496
260 MM

C261497
275 MM

C261498
320 MM

C261500
335 MM



CLAMP VASCULAIRE DEBAKEY 330 MM EN S AORTIQUE ANEURISME

C261499 DEBAKEY CLAMP VASCULAR 330 MM S FORM AORTIC ANEURYSM



CLAMP VASCULAIRE HARKEN
260 MM AURICULAIRE FIGURE 2

C261503 HARKEN VASCULAR
CLAMP 260 MM FOR
ATRIAL FIG. 2



C261502
265 MM
FIGURE 1



C261503
260 MM
FIGURE 2



C261504
250 MM
FIGURE 3



EN COURS DE
FABRICATION
 IN'SURG
2024

C261505
245 MM
FIGURE 4

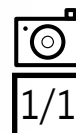

CLAMP VASCULAIRE BRONCHES

BRONCHIAL VASCULAR CLAMP

www.in-surg.fr



CLAMP VASCULAIRE LEES 250 MM BRONCHES FIG 1
C261506 LEES VASCULAR CLAMP 250 MM BRONCHIAL FIG. 1



C261507
250 MM FIGURE 2



C261508
230 MM FIGURE 3



1/1



IN'SURG

CLAMP VASCULAIRE BRONCHES *BRONCHIAL VASCULAR CLAMP*

CLAMP VASCULAIRE PRICE THOMAS 220 MM COURBE POINTES A DROITE EN HAUT
PR BRONCHES

C261509 *PRICE THOMAS VASCULAR CLAMP 220 MM RIGHT POINTS CURVE FOR BRONCHIS*



220 MM POINTES A GAUCHE

C261510 *LEFT POINTS CURVE*

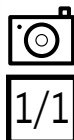

CLAMP VASCULAIRE PRICE THOMAS 220 MM BRONCHES
C261511 PRICE THOMAS VASCULAR CLAMP 220 MM FOR BRONCHIS

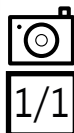

CLAMP VASCULAIRE BULLDOG (A CREMAILLERE)

BULLDOG VASCULAR CLAMP (WITH RATCHET)

CLAMP VASCULAIRE BULLDOG DEBAKEY 100 MM COUDE A 90°

C261517 *BULLDOG DEBAKEY VASCULAR CLAMP 100 MM ANGLED 90°*



C261517
100 MM COUDE A 90°
ANGLED 90°



C261518
130 MM COURBE
CURVED



C261519
130 MM DROIT
STRAIGHT

CLAMP VASCULAIRE BULLDOG DEBAKEY
130 MM COUDE A 45°

C261520 *BULLDOG DEBAKEY VASCULAR
CLAMP 130 MM ANGLED 45°*



CLAMP VASCULAIRE BULLDOG DEBAKEY
130 MM COURBE EN S

C261521 *BULLDOG DEBAKEY VASCULAR
CLAMP 130 MM CURVED S FORM*



CLAMP VASCULAIRE BULLDOG JOHN HOPKINS 90 MM COURBE

C261522 *BULLDOG JOHN HOPKINS VASCULAR CLAMP 90 MM CURVED*

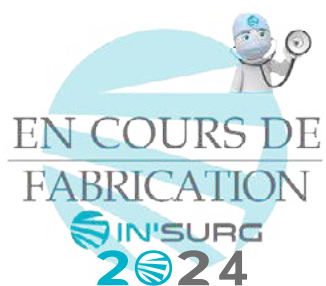



IN'SURG

CLAMP VASCULAIRE CAROTIDES

CAROTID VASCULAR CLAMP

CLAMP VASCULAIRE 185 MM MORS COOLEY CAROTIDES

C261524

VASCULAR CLAMP 185 MM JAWS COOLEY FOR CAROTID ARTERIES

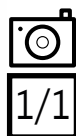

CLAMP VASCULAIRE JAVID 3,5 x 170 MM CAROTIDES

C261525 JAVID VASCULAR CLAMP 3,5 X 170 MM FOR CAROTID ARTERIES



C261525

3.5 X 170 MM



C261526

5.6 X 180 MM

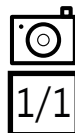



IN'SURG

CLAMP VASCULAIRE COARCTATION

COARCTATION VASCULAR CLAMP

CLAMP VASCULAIRE 175 MM DROIT MORS COOLEY COARCTATION

C261528 VASCULAR CLAMP 175 MM JAWS COOLEY STRAIGHT COARCTATION

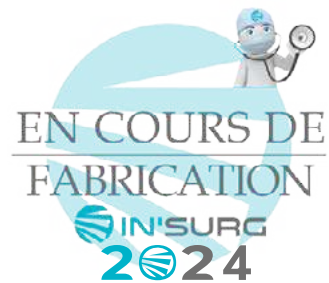
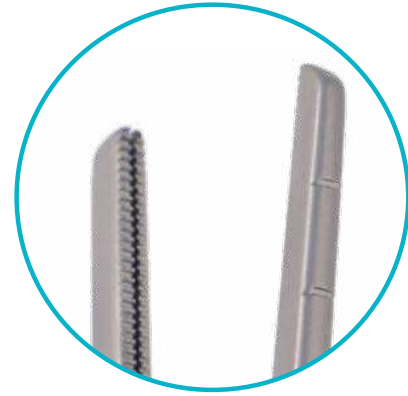

C261527

175 MM COUDE

ANGLED

CLAMP VASCULAIRE 180 MM DROIT MORS DEBAKEY COARCTATION
C261534 VASCULAR CLAMP 180 MM JAWS DEBAKEY STRAIGHT COARCTATION

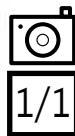
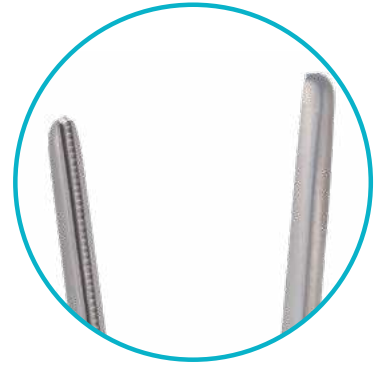

C261534
180 MM DROIT
STRAIGHT



C261531
180 MM COUDE
ANGLED

CLAMP VASCULAIRE 180 MM COURBE MORS COOLEY COARCTATION

C261529 VASCULAR CLAMP 180 MM JAWS COOLEY CURVED COARCTATION



C261529
180 MM COURBE
CURVED



C261530
180 MM EN CUILLERE
SPOON FORM

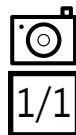

CLAMP VASCULAIRE 180 MM EN CUILLERE MORS DEBAKEY COARCTATION

C261533 VASCULAR CLAMP 180 MM JAWS DEBAKEY SPOON FORM COARCTATION

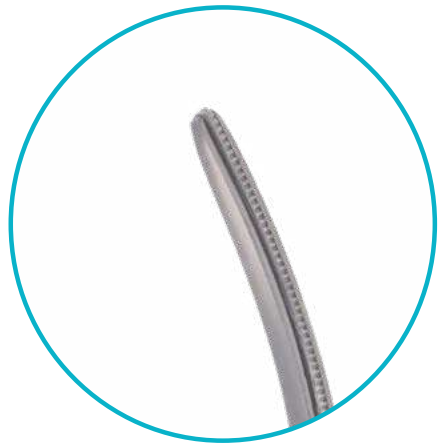

C261532
180 MM COURBE
CURVED



C261533
180 MM EN CUILLERE
SPOON FORM





CLAMP VASCULAIRE COARCTATION

COARCTATION VASCULAR CLAMP

CLAMP VASCULAIRE 210 MM COURBE MORS DEBAKEY COARCTATION

C261535 VASCULAR CLAMP 210 MM JAWS DEBAKEY CURVED COARCTATION

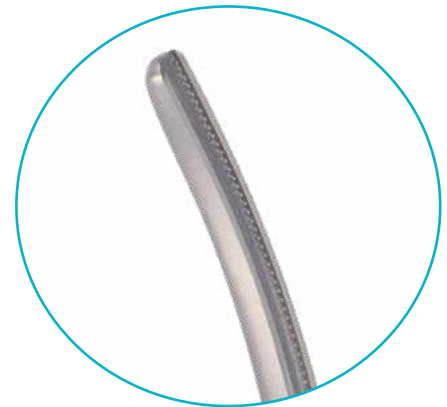

COURBE
CURVED

DROIT
STRAIGHT

LONGUEUR
LENGTH

210 MM

C261535

C261536

230 MM

C261537

C261538

270 MM

C261539

C261540

315 MM

C261541

C261542



1/1

CLAMP VASCULAIRE 220 MM MORS EN CUILLERE GLOVER DEBAKEY COARCTATION
C261547 VASCULAR CLAMP 220 MM JAWS GLOVER DEBAKEY SPOON FORM COARCTATION

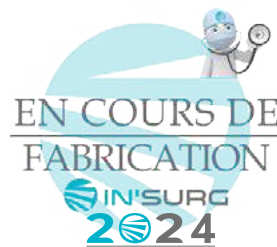

C261544

210 MM COURBE
CURVED



C261547

220 MM
EN CUILLERE
SPOON FORM





CLAMP VASCULAIRE 210 MM DROIT MORS GLOVER DEBAKEY COARCTATION

C261545 VASCULAR CLAMP 210 MM JAWS GLOVER DEBAKEY STRAIGHT COARCTATION



COUDE
ANGLED

DROIT
STRAIGHT

LONGUEUR
LENGTH

210 MM

220 MM

C261546

C261549

C261545

C261548

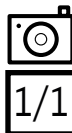

CLAMP VASCULAIRE 220 MM BRANCHES COUDEES MORS GLOVER DEBAKEY COARCTATION

C261551 VASCULAR CLAMP 220 MM JAWS GLOVER DEBAKEY ARMS ANGLED COARCTATION



C261550
210 MM

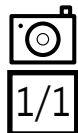

CLAMP VASCULAIRE BAHNSON 260 MM MORS DEBAKEY
MOYENNE COURBURE ILIAQUE

C261555 BAHNSON VASCULAR CLAMP 260 MM JAWS DEBAKEY
MEDIUM CURVATURE ILIAC



C261554
260 MM LEGERE
COURBURE
SMALL CURVATURE



C261555
260 MM MOYENNE
COURBURE
MEDIUM CURVATURE



C261553
250 MM GRANDE
COURBURE
LARGE CURVATURE

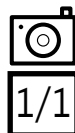

CLAMP VASCULAIRE LIGATURE DISSECTION

www.in-surg.fr



LIGATURE DISSECTION VASCULAR CLAMP

CLAMP VASCULAIRE 190 MM MORS DEBAKEY
LIGATURE DISSECTION

C261556 VASCULAR CLAMP 190 MM JAWS DEBAKEY
LIGATURE DISSECTION

CLAMP VASCULAIRE 265 MM SEMB
MORS DEBAKEY LIGATURE DISSECTION

C261558 SEMB VASCULAR CLAMP 265 MM
JAWS DEBAKEY LIGATURE DISSECTION



C261557
230 MM

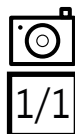



IN'SURG

CLAMP VASCULAIRE MULTIPOSE

MULTIPOSE VASCULAR CLAMP

CLAMP VASCULAIRE 150 MM COUDE A 90° MORS COOLEY MULTIPOSE

C261561 VASCULAR CLAMP 150 MM JAWS COOLEY ANGLED 90° MULTIPOSE

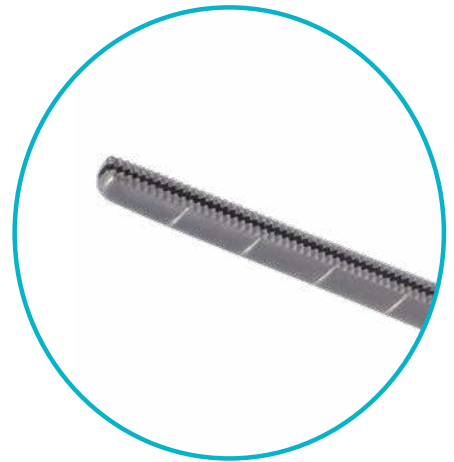

170 MM COUDE 30°

C261559 ANGLED 30°

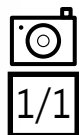

165 MM COUDE 60°

C261560 ANGLED 60°



150 MM COUDE 90°

C261561 ANGLED 90°

CLAMP VASCULAIRE 165 MM COUDE A 60° MORS DEBAKEY MULTIPOSE
C261563 *VASCULAR CLAMP 165 MM JAWS DEBAKEY ANGLED 60° MULTIPOSE*

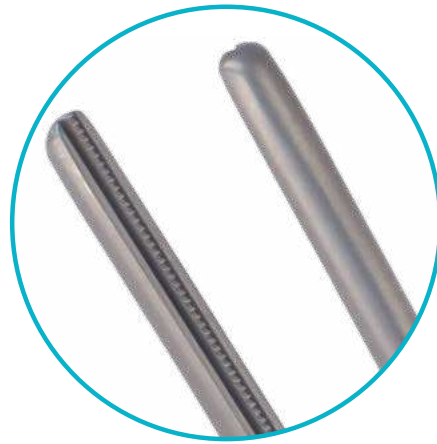

170 MM COUDE 30°
C261562 *ANGLED 30°*



150 MM COUDE 90°
C261568 *ANGLED 90°*

165 MM COUDE 60°
C261563 *ANGLED 60°*

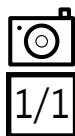



INSURG

CLAMP VASCULAIRE MULTIPOSE

MULTIPOSE VASCULAR CLAMP

CLAMP VASCULAIRE 45 X 220 MM COUDE A 60° MORS DEBAKEY MULTIPOSE

C261564 VASCULAR CLAMP 45 X 220 MM JAWS DEBAKEY ANGLED 60° MULTIPOSE



C261565

40 X 235 MM
COUDE A 60°
ANGLED 60°



C261566

70 X 245 MM
COUDE A 60°
ANGLED 60°



C261567

95 X 320 MM
COUDE A 60°
ANGLED 60°

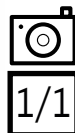

CLAMP VASCULAIRE 45 X 200 MM COUDE A 90° MORS DEBAKEY MULTIPOSE

C261569 VASCULAR CLAMP 45 X 200 MM JAWS DEBAKEY ANGLED 90° MULTIPOSE



C261571
40 X 250 MM
COUDE A 90°
ANGLED 90°

C261570
70 X 230 MM
COUDE A 90°
ANGLED 90°

C261572
105 X 260 MM
COUDE A 90°
ANGLED 90°

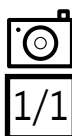



CLAMP VASCULAIRE OCCLUSION TANGENTIELLE *TANGENTIAL OCCLUSION VASCULAR CLAMP*

CLAMP VASCULAIRE SATINSKY 35 X 195 MM MORS DEBAKEY OCCLUSION TANGENTIELLE
C261573 *SATINSKY VASCULAR CLAMP 35 X 195 MM JAWS DEBAKEY ANGLED TANGENTIAL OCCLUSION*



1/1



C261574
32 X 255

C261575
40 X 255



C261576
50 X 255

C261578
55 X 255

C261579
60 X 255

C261580
80 X 255



IN'SURG

CLAMP VASCULAIRE PEDIATRIQUE

PEDIATRIC VASCULAR CLAMP

CLAMP VASCULAIRE CASTANEDA 150 MM COURBURE N°2 PEDIATRIQUE

C261583 *CASTANEDA VASCULAR CLAMP 150 MM CURVATURE N°2 PEDIATRIC*



C261582
150 MM N°1 PEDIATRIQUE
N°1 PEDIATRIC



C261583
150 MM N°2 PEDIATRIQUE
N°2 PEDIATRIC



C261584
150 MM N°3 PEDIATRIQUE
N°3 PEDIATRIC



C261585
120 MM N°4 PEDIATRIQUE
N°4 PEDIATRIC



C261586
110 MM COUDE A 30°
ANGLED AT 30°



C261587
130 MM COUDE A 45°
ANGLED AT 45°



C261588
110 MM COUDE A 90°
ANGLED AT 90°



CLAMP VASCULAIRE 140 MM MORS COOLEY TANGENTIEL PEDIATRIQUE

C261605 *VASCULAR CLAMP 140 MM JAWS COOLEY TANGENTIAL PEDIATRIC*

CLAMP VASCULAIRE 140 MM EN CUILLERE MORS COOLEY PEDIATRIQUE

C261593 *VASCULAR CLAMP 140 MM JAWS COOLEY SPOON FORM PEDIATRIC*



CLAMP VASCULAIRE 160 MM COUDE A 30° MORS COOLEY PEDIATRIQUE

C261591 *CASTANEDA VASCULAR CLAMP 160 MM JAWS COOLEY ANGLED 30° PEDIATRIC*





IN'SURG

CLAMP VASCULAIRE PEDIATRIQUE

PEDIATRIC VASCULAR CLAMP

CLAMP VASCULAIRE 145 MM ANGULATION MORS COOLEY PEDIATRIQUE

C261597

VASCULAR CLAMP 145 MM JAWS COOLEY ANGULATION PEDIATRIC

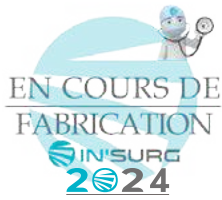
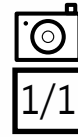

C261596
145 MM



C261597
145 MM



C261598
135 MM



C261600
135 MM



C261604
145 MM



C261599
140 MM



C261601
135 MM



C261602
140 MM



C261603
135 MM

CLAMP VASCULAIRE 35 X 180 MM MORS COOLEY TANGENTIEL PEDIATRIQUE
C261607 VASCULAR CLAMP 35 X 180 MM JAWS COOLEY TANGENTIAL PEDIATRIC



C261606
30 X 170 MM



C261607
35 X 180 MM

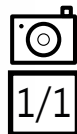

CLAMP VASCULAIRE BAINBRIDGE 60 X 196 MM COURBE PERIPHERIQUE

C261612 BAINBRIDGE VASCULAR CLAMP 60 X 196 MM CURVED PERIPHERAL



C261613

40 X 178 MM DROIT

STRAIGHT

C261614

60 X 200 MM DROIT

STRAIGHT

C261611

40 X 174 MM COURBE

CURVED

C261612

60 X 196 MM COURBE

CURVED

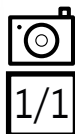

CLAMP VASCULAIRE 170 MM LARGE MORS COOLEY PERIPHERIQUE

C261615 VASCULAR CLAMP 170 MM JAWS COOLEY LARGE PERIPHERAL

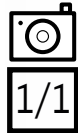

CLAMP VASCULAIRE 170 MM MEDIUM MORS COOLEY PERIPHERIQUE

C261616 VASCULAR CLAMP 170 MM JAWS COOLEY MEDIUM PERIPHERAL

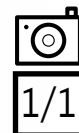



IN'SURG

CLAMP VASCULAIRE PERIPHERIQUE

VASCULAR CLAMP PERIPHERAL

CLAMP VASCULAIRE DALE 175 MM COURBE FEMORALE POPLITEE PERIPHERIQUE

C261617 DALE VASCULAR CLAMP 175 MM CURVED FEMORAL POPLITEAL PERIPHERAL



C261618
185 MM COURBE
CURVED

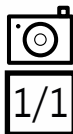

C261620
175 MM MM
LEGEREMENT COURBE
SLIGHTLY CURVED

C261619
185 MM COUDE
ANGLED

CLAMP VASCULAIRE 160 MM MORS DEBAKEY PERIPHERIQUE
C261622 VASCULAR CLAMP 160 MM JAWS DEBAKEY PERIPHERAL



C261623
170 MM

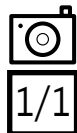



IN'SURG

CLAMP VASCULAIRE PERIPHERIQUE

VASCULAR CLAMP PERIPHERAL

CLAMP VASCULAIRE 65 X 195 MM COUDE A 60° MORS DEBAKEY PERIPHERIQUE

C261624 VASCULAR CLAMP 65 X 195 MM JAWS DEBAKEY ANGLED 60° PERIPHERAL



CLAMP VASCULAIRE 40 X 160 MM COURBE MORS DEBAKEY PERIPHERIQUE

C261625 VASCULAR CLAMP 40 X 160 MM JAWS DEBAKEY CURVED PERIPHERAL

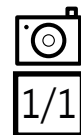
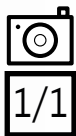

CLAMP VASCULAIRE 205 MM MORS DEBAKEY EN S PERIPHERIQUE
C261626 VASCULAR CLAMP 205 MM JAWS DEBAKEY S FORM PERIPHERAL

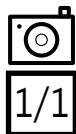



INSURG

CLAMP VASCULAIRE PERIPHERIQUE

VASCULAR CLAMP PERIPHERAL

CLAMP VASCULAIRE GREGORY 150 MM PERIPHERIQUE

C261630 GREGORY VASCULAR CLAMP 150 MM PERIPHERAL



C261630
150 MM

C261631
180 MM

C261632
200 MM



CLAMP VASCULAIRE LELAND JONES 195 MM COUDE A 15° PERIPHERIQUE
C261633 LELAND JONES VASCULAR CLAMP 195 MM ANGLED 15° PERIPHERAL



C261633
195 MM COUDE A 15°
ANGLED AT 15°



C261634
210 MM COUDE A 30°
ANGLED AT 30°

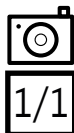



CLAMP VASCULAIRE 200 MM MORS DEBAKEY RENAL
C261636 VASCULAR CLAMP 200 MM JAWS DEBAKEY RENAL



CLE CAMBRAGE / PLATE

www.in-surg.fr



CAMBER / FLAT KEY

CLE DE CAMBRAGE 2,4 - 4,0 X 145 MM
A GAUCHE

C271643 CAMBER KEY 2,4 - 4,0 X 145 MM
TO THE LEFT

CLE DE CAMBRAGE 2,4 - 4,0 X 145 MM
A DROITE

C271644 CAMBER KEY 2,4 - 4,0 X 145 MM
TO THE RIGHT





CLIPS (PINCE À POSER) CLIPS (FORCEPS FOR PLACING)

PINCE A POSER LES CLIPS STANDARD PHYNOX 170 MM EN BAIONNETTE

C281647 FORCEPS TO INSTALL THE STANDARD CLIPS PHYNOS 170 MM IN BAYONET



C281648
210 MM

C281649
230 MM

COMPRESSOR

COMPRESSEUR STRAUSS PR VERGE-URETHRE

C291651 URETHRAL-ROD COMPRESSOR



COSTOTOME

RIB SHEAR

COSTOTOME BETHUNE 350 MM

C301652 BETHUNE RIB SHEAR 350 MM

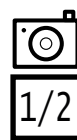

COSTOTOME BRUNNER 300 MM COUPE A GAUCHE

C301654 BRUNNER RIB SHEAR 300 MM LEFT CUT



C301653
COUPE A DROITE
RIGHT CUT



C301654
COUPE A GAUCHE
LEFT CUT

COSTOTOME

RIB SHEAR

COSTOTOME COLLIN ESLANDER 190 MM ADULTE
C301656 COLLIN ESLANDER RIB SHEAR 190 MM ADULT



C301656
190 MM -ADULTE
ADULT



C301655
170 MM - ENFANT
CHILDREN

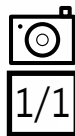

COSTOTOME CORYLLOS BETHUNE 350 MM CROCHET A GAUCHE

C301658 CORYLLOS BETHUNE RIB SHEAR 350 MM HOOK TO THE LEFT



C301657
350 MM
CROCHET A DROITE
HOOK TO THE RIGHT



C301658
350 MM
CROCHET A GAUCHE
HOOK TO THE LEFT

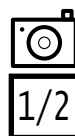

COSTOTOME MAURER COLLIN 240 MM CROCHET A DROITE

C301661 MAURER COLLIN RIB SHEAR 240 MM HOOK TO THE RIGHT



CROCHET A DROITE
HOOK TO THE RIGHT



CROCHET A GAUCHE
HOOK TO THE LEFT

LONGUEUR
LENGTH

240 MM

C301661

C301662

300 MM

C301663

C301664

COSTOTOME STILLE 210 MM
C301669 *STILLE RIB SHEAR 210 MM*

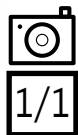

COUTEAU AMPUTATION

AMPUTATION KNIFE



LONGUEUR DE LAME 120 MM
BLADE LENGTH 120 MM

COUTEAU AMPUTATION LAME 120 MM

C311672 AMPUTATION KNIFE BLADE 120 MM

C311671
100 MM

C311673
150 MM

C311674
180 MM

C311675
200 MM

C311676
220 MM

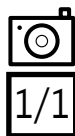

COUTEAU MENISQUE

www.in-surg.fr



MENISCUS KNIFE

COUTEAU MENISQUE SMILLIE TRILLAT DROIT

C321680 *SMILLIE TRILLAT MENISCUS KNIFE STRAIGHT*



COUTEAU MENISQUE SMILLIE TRILLAT TRANCHANT A DROITE

C321681 *SMILLIE TRILLAT MENISCUS KNIFE SHARP TO THE RIGHT*



TRANCHANT A DROITE
C321681 *SHARP TO THE RIGHT*

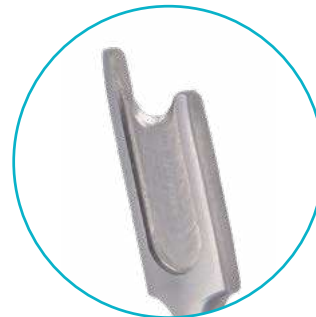

TRANCHANT A GAUCHE
C321682 *SHARP TO THE LEFT*

COUTEAU NEURO

NEURO KNIFE

COUTEAU NEURO HARDY FAHLBUSH
245 MM COUDE ARRIERE

C331690 *HARDY FAHLBUSH NEURO KNIFE
245 MM ANGLED BACKWARD*



C331690
245 MM
COUDE ARRIERE
ANGLED BACKWARD



C331691
245 MM
COUDE AVANT
ANGLED FORWARD

COUTEAU NEURO JACKSON 185 MM
A VAISSEAUX

C331692 *JACKSON KNIFE 185 MM
FOR VESSELS*

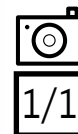
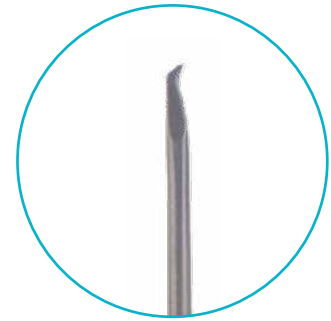



COUTEAU NEURO LANDOLT 260 MM MOUSSE A GAUCHE MALLEABLE
C331700 *LANDOL NEURO KNIFE 260 MM LEFT BLUNT MALLEABLE*



C331699
260 MM
MOUSSE A DROITE MALLEABLE
RIGHT BLUNT MALLEABLE



C331700
260 MM
MOUSSE A GAUCHE MALLEABLE
LEFT BLUNT MALLEABLE

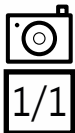



COUTEAU NEURO SAMII 1 X 230 MM

C331702 *SAMII NEURO KNIFE 1 X 230 MM*



C331701
3 X 200 MM

C331703
1,5 X 230 MM

C331704
2 X 230 MM

C331705
2,5 X 230 MM

C331706
3 X 230 MM

C331707
3,5 X 230 MM

C331708
4 X 230 MM

C331709
5 X 230 MM

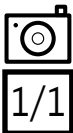

COUTEAU NEURO YASARGIL 185 MM
COURBE ARRIERE EN BAIONNETTE
C331710 *YASARGIL NEURO KNIFE 185 MM*
REAR CURVE BAYONET



COUTEAU NEURO YASARGIL 185 MM
COURBE AVANT EN BAIONNETTE
C331711 *YASARGIL NEURO KNIFE 185 MM*
FRONT CURVE BAYONET



COUTEAU O.R.L BALLENGER 5 MM ANGULE RHINOPLASTIE

C341714 *BALLENGER ENT KNIFE 5 MM ANGULATED RHINOPLASTY*



LONGUEUR LENGTH	DROIT STRAIGHT	ANGULE ANGLED
	3 MM	
4 MM	C341716	C341713
5 MM	C341715	C341714

COUTEAU O.R.L BECKMANN 20 MM
COURBE AMYGDALÉ VEGETATION

C341717 *BECKMANN ENT KNIFE
20 MM CURVED TONSILS
ADENOID*

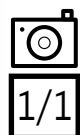

COUTEAU O.R.L BECKMANN LARGEUR
INT. 13 MM AMYGDALÉ VEGETATION

C341720 *BECKMANN ENT KNIFE 20 MM
INTERIOR WIDTH 13 MM TONSILS
ADENOID*



C341723
10 MM

C341718
11 MM

C341719
12 MM

C341721
15 MM

C341722
18 MM

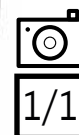

COUTEAU O.R.L

E.N.T KNIFE

COUTEAU O.R.L COTTLE BOUTONNE
RHINOPLASTIE

C341724 COTTLE ENT KNIFE BUTTONED
RHINOPLASTY

COUTEAU O.R.L LERMOYER 10 X 230 MM

C341725 LEMOYER ENT KNIFE 10 X 230 MM

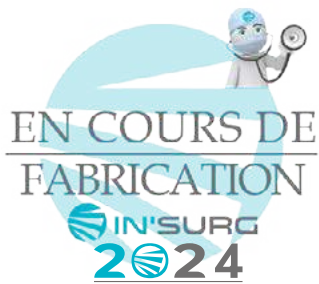

C341726
13 X 230 MM

C341727
16 X 230 MM



COUTEAU O.R.L MOURE 10 x 220 MM A PANIER
C341728 MOURE ENT KNIFE 10 X 220 MM WITH BASKET



C341729
13 X 220 MM

C341730
16 X 220 MM

C341731
19 X 220 MM

C341732
21 X 220 MM

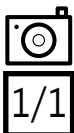

COUTEAU O.R.L MOURE 10 x 210 MM
SANS PANIER
C341733 MOURE ENT KNIFE 10 X 210 MM
WITHOUT BASKET



C341734
13 X 210 MM

C341735
16 X 210 MM

C341736
19 X 210 MM

C341737
21 X 210 MM

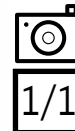

COUTEAU / FAUX O.R.L RUAULT 220 MM
ADULTE MOUSSE

C341738 *RUAULT ENT KNIFE / SCYTHE
220 MM BLUNT ADULT*



C3417338
220 MM - ADULTE
ADULT



C341739
220 MM - ENFANT
CHILDREN

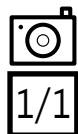

COUTEAU / FAUX O.R.L RUAULT 220 MM
ADULTE POINTU

C341740 *RUAULT ENT KNIFE / SCYTHE
220 MM SHARP ADULT*

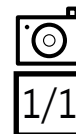

COUTEAU O.R.L SAINT CLAIR THOMPSON 14 MM VEGETATION

C341742 SAINT CLAIR THOMPSON ENT KNIFE 14 MM ADENOID

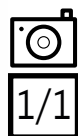

C341741
12 MM



C341742
14 MM



C3417443
16 MM



C341744
17 MM



COUTEAU PLATRE LANCE

C351745 *LANCE KNIFE PLASTER*



HOOK

CROCHET FISCH 180 MM ANGULE POINTU
C361746 FISCH HOOK 180 MM ANGLED SHARP

CROCHET FISCH 180 MM COURBE POINTU
C361747 FISCH HOOK 180 MM CURVED SHARP

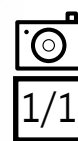
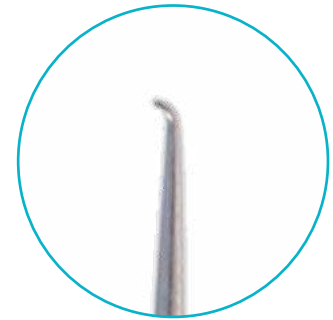

CROCHET

HOOK

CROCHET ADSON 140 MM POINTU
C361748 ADSON HOOK 140 MM SHARP

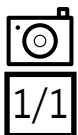

CROCHET BANKART POUR FILS / SUTURES
C361749 BANKART HOOK FOR WIRE SUTURE

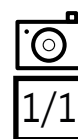

CROCHET BARSKY 150 MM POINTU
C361750 *BARSKY HOOK 150 MM SHARP*

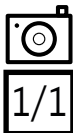

CROCHET BERGMANN 140 MM POINTU
C361751 *BERGMANN HOOK 140 MM SHARP*

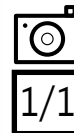

CROCHET

HOOK

CROCHET BOSE 160 MM A DROITE POINTU

C361753 BOSE HOOK 160 MM SHARP TO THE RIGHT

CROCHET BOSE A DROITE

BOSE HOOK AT THE RIGHT

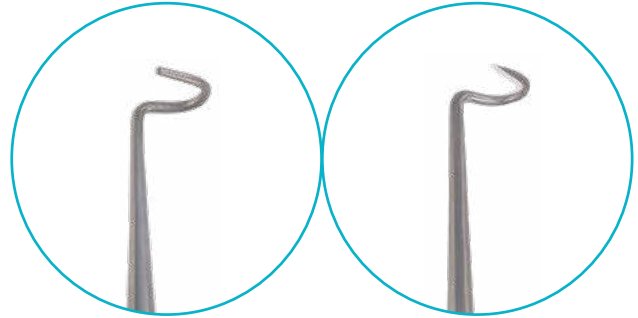

LONGUEUR
LENGTH

160 MM

MOUSSE
BLUNT

C361752

POINTU
SHARP

C361753

CROCHET BOSE A GAUCHE

BOSE HOOK AT THE LEFT

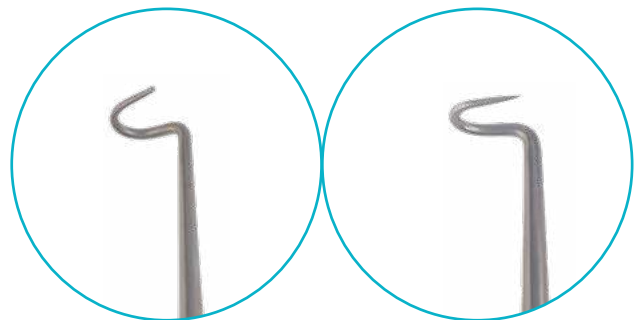

LONGUEUR
LENGTH

160 MM

MOUSSE
BLUNT

C361754

POINTU
SHARP

C361755

CROCHET BRAUN 300 MM PR DECAPITATION
C361756 *BRAUN HOOK 300 MM FOR DECAPITATION*

CROCHET CASPAR 245 MM COUDE A 90°
PETIT MODELE ISOLE

C361757 *CASPAR HOOK 245 MM*
ANGLED 90° SMALL MODEL
INSULATED

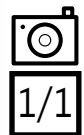
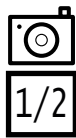

CROCHET

HOOK

CROCHET CLOWARD 165 MM MOUSSE A RACINE
C361758 CLOWARD HOOK 165 MM BLUNT FOR ROOT

CROCHET CLOWARD 165 MM POINTU
 A DURE MERE

C361759 CLOWARD HOOK 165 MM SHARP
 FOR DURA MATER



CROCHET COTTLE 140 MM POINTU DOUBLE
C361760 COTTLE HOOK 140 MM DOUBLE SHARP



CROCHET CRILE 140 MM
C361761 CRILE HOOK 140 MM

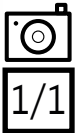

CROCHET CRILE 220 MM
COUDE A 45° MOUSSE
C361762 CRILE HOOK 220 MM
ANGLED 45° BLUNT



C361763
220 MM A 90°

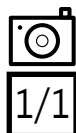

CROCHET CRILE 220 MM
COURBE MOUSSE
C361764 CRILE HOOK 220 MM
CURVED BLUNT

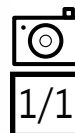

CROCHET

HOOK

CROCHET CUSHING 6 X 190 MM FORT MOUSSE
C361767 CUSHING HOOK 6 X 190 MM BLUNT STRONG

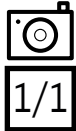

FIN MOUSSE
BLUNT SLIM
4 MM

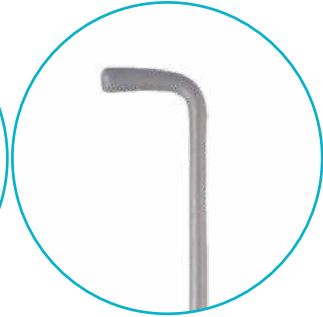

FORT MOUSSE
BLUNT STRONG
6 MM

LONGUEUR

LENGTH

190 MM

C361766

C361767

280 MM

C361768

C361769

CROCHET CUSHING 130 MM POINTU
C361765 CUSHING HOOK 130 MM SHARP

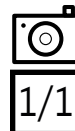

CROCHET DANDY 230 MM DROIT MOUSSE

C361772 *DANDY HOOK 230 MM BLUNT STRAIGHT*



COUDE A DROITE MOUSSE
C361770 *BLUNT ANGLED TO THE RIGHT*



COUDE A GAUCHE MOUSSE
C361771 *BLUNT ANGLED TO THE LEFT*

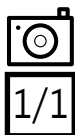

CROCHET DINGMANN 20 X 190 MM MAXILLO FACIAL
C361775 *DINGMANN HOOK 20 X 190 MM MAXILLO FACIAL*



C361774
10 X 190 MM



C361775
20 X 190 MM



**CROCHET FRAZIER 130 MM
POINTU**

C361776 *FRAZIER HOOK 130 MM
SHARP*

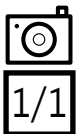

**CROCHET GILLIES 190 MM
FIN POINTU**

C361777 *GILLIES HOOK 190 MM
SLIM SHARP*

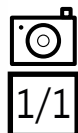

**CROCHET GILLIES 190 MM
FORT POINTU**

C361778 *GILLIES HOOK 190 MM
STRONG SHARP*

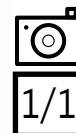

CROCHET

HOOK

CROCHET GINESTET 240 MM GRAND

C361779 GINESTET HOOK 240 MM LARGE



C361781

PETIT
SMALL



C361780

MOYEN
MEDIUM



C361779

GRAND
LARGE

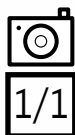

CROCHET GRAEFE 160 MM MOUSSE TISSUS

C361784 GRAEFFE HOOK 160 MM BLUNT TISSUS



C361782
120 MM



C361784
160 MM

CROCHET GRAEFE 120 MM POINTU TISSUS

C361783 GRAEFFE HOOK 120 MM SHARP TISSUS



C361783
120 MM



C361785
160 MM

CROCHET

HOOK

CROCHET GRAHAM 165 MM MOUSSE NERFS

C361786 GRAHAM HOOK 165 MM BLUNT NERVE



CROCHET GUTHRIE 130 MM POINTU DOUBLE A DURE MERE

C361789 GUTHRIE HOOK 130 MM DOUBLE SHARP FOR DURA MATER

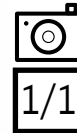

C361788
120 MM

CROCHET GUERRIER POUR LARYNX

C361787 GUERRIER HOOK FOR LARYNX

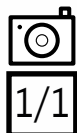

CROCHET HUMBY 110 MM DOUBLE
C361790 *HUMBIE HOOK 110 MM DOUBLE*

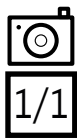

CROCHET JACKSON 150 MM POINTU
C361792 *JACKSON HOOK 150 MM SHARP*



CROCHET JACKSON 130 MM POINTU
C361791 *JACKSON HOOK 130 MM SHARP*

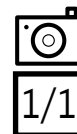

CROCHET

HOOK

CROCHET JOSEPH 160 MM POINTU 1 GRIFFE
C361793 JOSEPH HOOK 160 MM SHARP 1 TOOTH

CROCHET JOSEPH 2 X 160 MM POINTU DOUBLE
C361794 JOSEPH HOOK 2 X 160 MM SHARP 2 TEETH

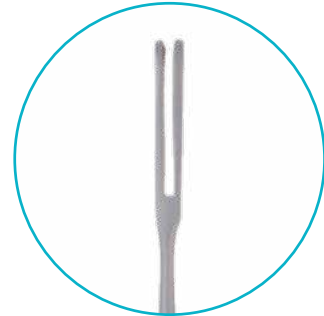

C361794
2 X 160 MM

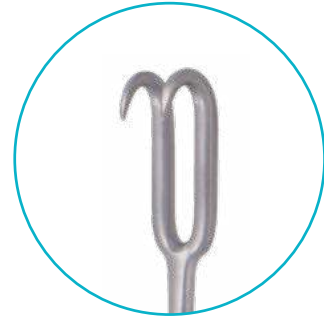

C361795
5 X 160 MM



C361796
7 X 160 MM

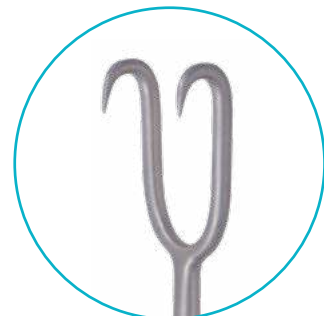

C361797
10 X 160 MM

CROCHET KLEINERT KUTZ 7 X 160 MM POINTU

C361800 *KLEINERT KUTZ HOOK 7 X 160 MM SHARP*



C361798
3 X 160 MM



C361799
5 X 160 MM



C361800
7 X 160 MM

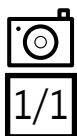

CROCHET KRAYENBUHL 2,5 X 185 MM GRAND MOUSSE

C361801 *KRAYENBUHL HOOK 2,5 X 185 MM LARGE BLUNT*

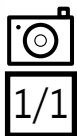

C361803

2 X 185 MM

PETIT MOUSSE
SMALL BLUNT



C361804

2,5 X 185 MM

PETIT MOUSSE BOUTONNE
SMALL BLUNT BUTTONE

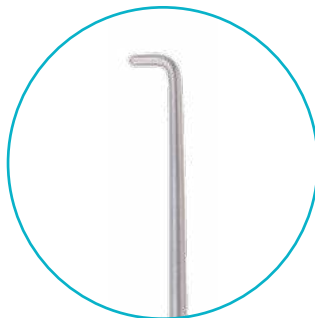

C361801

2,5 X 185 MM

GRAND MOUSSE
LARGE BLUNT



C361802

3,5 X 185 MM

GRAND MOUSSE BOUTONNE
LARGE BLUNT BUTTONE

CROCHET LAMBOTTE 220 MM PETIT MODELE
C361805 *LAMBOTTE HOOK 220 MM SMALL MODEL*



C361805
220 MM
PETIT MODELE
SMALL MODEL



C361806
250 MM
MOYEN MODELE
MEDIUM MODEL



C361807
280 MM
GRAND MODELE
LARGE MODEL

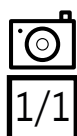

CROCHET

HOOK

CROCHET LANGE 220 MM
BOUTONNE

C361808 LANGE HOOK 220 MM
BUTTONE



CROCHET MANNERFELT 155 MM
PETITE COURBURE MOUSSE

C361809 MANNERFELT HOOK 155 MM
SMALL CURVATURE BLUNT



CROCHET MANNERFELT
155 MM POINTU

C361810 MANNERFELT HOOK
155 MM SHARP



CROCHET MULLER N°1

C361811 MULLER HOOK N°1

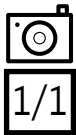

CROCHET MULLER N°2

C361812 MULLER HOOK N°2



CROCHET MULLER N°3

C361839 MULLER HOOK N°3

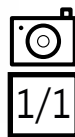

CROCHET MULLER N°4

C361840 MULLER HOOK N°4

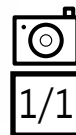

CROCHET

HOOK

CROCHET NEURO LANDOLT REULEN
1,7 X 260 MM MALLEABLE

C361813 LANDOLT REULEN NEURO
HOOK 1,7 X 260 MM MALLEABLE



CROCHET NEURO LANDOLT
REULEN 1,7 X 260 MM

C361814 LANDOLT REULEN
NEURO HOOK 1,7 X 260 MM

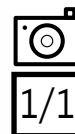
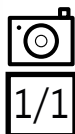
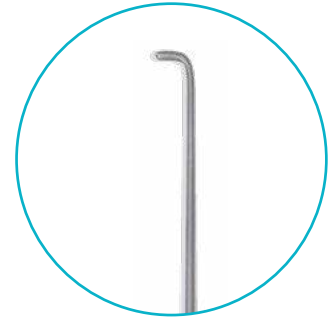

CROCHET NEURO MICRO 230 MM
DROIT MOUSSE

C361815 *NEURO MICRO HOOK 230 MM
STRAIGHT BLUNT*



CROCHET NEURO MICRO 230 MM
DROIT POINTU

C361816 *NEURO MICRO HOOK 230 MM
STRAIGHT SHARP*



CROCHET

HOOK

**CROCHET SIMON 220 MM
POINTU DOUBLE**

C361817 SIMON HOOK 220 MM
2 TEETH SHARP

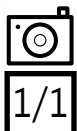

**CROCHET SIMON 220 MM
POINTU SIMPLE**

C361818 SIMON HOOK 220 MM
1 TOOTH SHARP

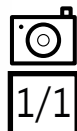

**CROCHET SMITHWICK 290 MM
DISSECTEUR**

C361819 SMITHWICK HOOK
290 MM DISSECTOR

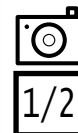

**CROCHET TONNIS 150 MM
POINTU**

C361820 *TONNIS HOOK
150 MM SHARP*

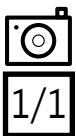

**CROCHET TRILLAT 240 MM
MOUSSE EXPLORATEUR**

C361821 *TRILLAT HOOK 240 MM
BLUNT EXPLORER*



**CROCHET TRILLAT 240 MM
MOUSSE MENISQUE**

C361822 *TRILLAT HOOK 240 MM
BLUNT MENISCUS*



CROCHET

HOOK

CROCHET VALUDE 150 MM 2 GRIFFES
C361823 VALUDE HOOK 150 MM 2 TEETH



3 GRIFFES
C361824 3 TEETH

4 GRIFFES
C361825 4 TEETH

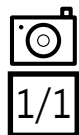

CROCHET VOLKMANN 245 MM POINTU
 A OS
C361828 VOLKMANN BONE HOOK 245 MM
 SHARP



C361827 POINTU
 220 MM SHARP

C361828 POINTU
 245 MM SHARP



C361826 MOUSSE
 220 MM BLUNT



CROCHET WAGNER 140 MM FIGURE 1
C361829 WAGNER HOOK 140 MM FIGURE 1

CROCHET WEARY 200 MM TRES FIN
DURE MERE

C361834 WEARY HOOK 200 MM VERY
BENT FOR DURA MATER

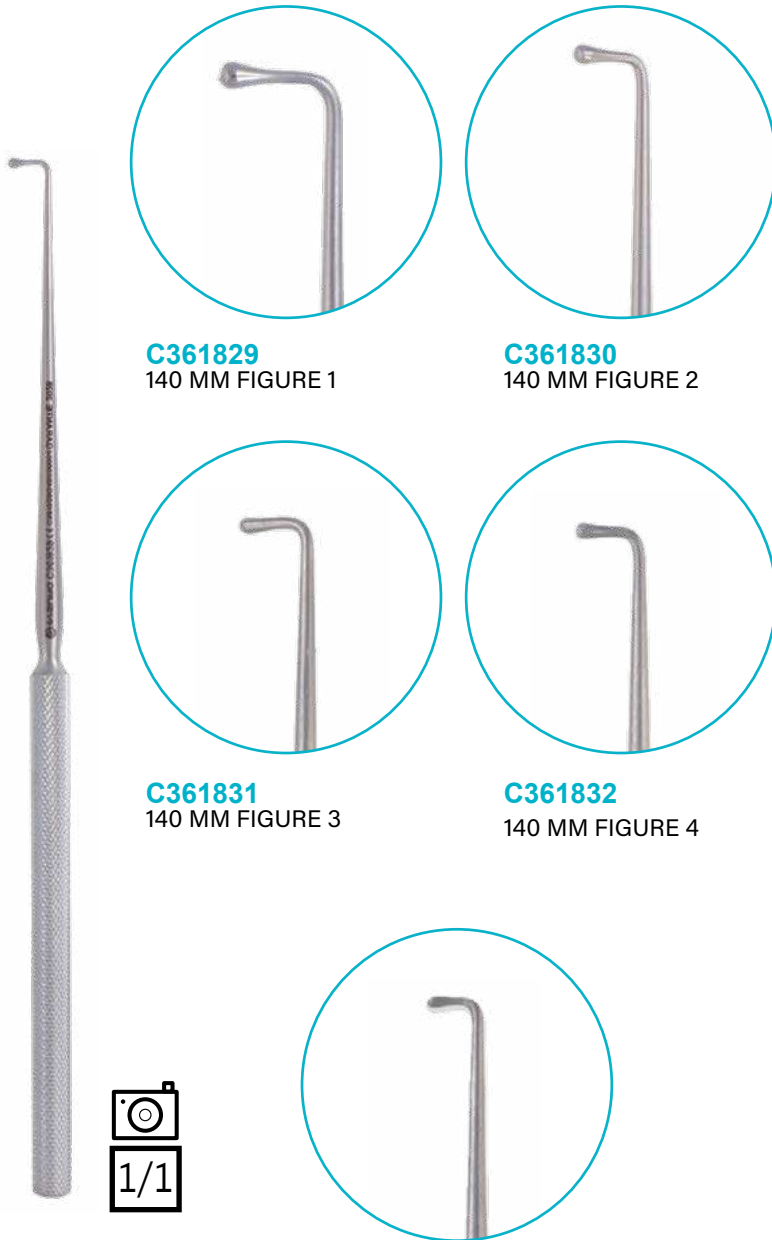

C361829
140 MM FIGURE 1

C361830
140 MM FIGURE 2

C361831
140 MM FIGURE 3

C361832
140 MM FIGURE 4



C361833
140 MM FIGURE 5



CROCHET

HOOK

CROCHET YASARGIL GRANDES GRIFFES A RESSORT

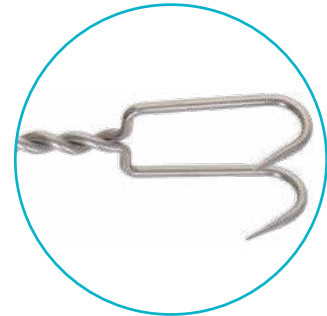
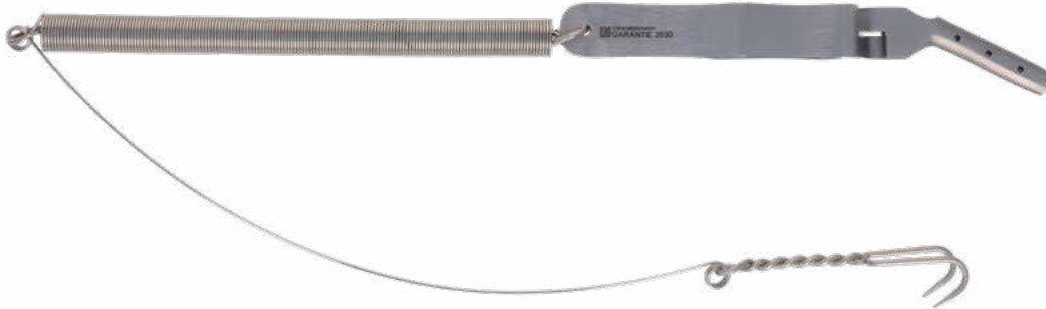
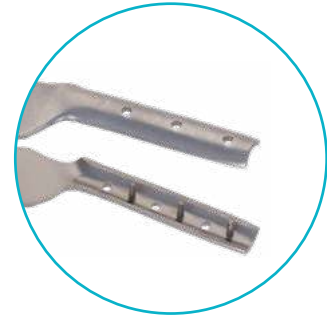
C361836 *YASARGIL HOOK LARGE TEETH WITH SPRING***C361837**
PETITES GRIFFES
SMALL TEETH

CUPULE

www.in-surg.fr



CUP

CUPULE INOX 150 MM CAPACITE 900CC

C371844 STAINLESS STEEL CUP 150 MM CAPACITY 900CC



DIAMETRE
DIAMETER

CAPACITE
CAPACITY

C371839	40 MM	15 CC
C371840	60 MM	75 CC
C371841	80 MM	225 CC
C371842	100 MM	325 CC
C371843	120 MM	500 CC
C371844	150 MM	900 CC
C371845	180 MM	1600 CC
C371846	200 MM	2000 CC
C371847	220 MM	3300 CC
C371848	240 MM	4000 CC



INFORMATION

- L'unité de calcul de volume d'une cupule est le centimètre cube (CC).

- 1 CC = 1 ml

CURETTE CALCULS BILIAIRES DESJARDINS
6 X 260 MM MOUSSE

C381849 DESJARDINS GALLSTONE CURETTE
6 X 260 MM BLUNT

CURETTE CALCULS BILIAIRES DESJARDINS
6 X 300 MM DRAGUE SOUPLE

C381853 DESJARDINS GALLSTONE CURETTE
6 X 300 MM FLEXIBLE DREDGE



C381849
6 X 260 MM



C381850
8 X 260 MM



C381851
10 X 260 MM



C381852
12 X 260 MM

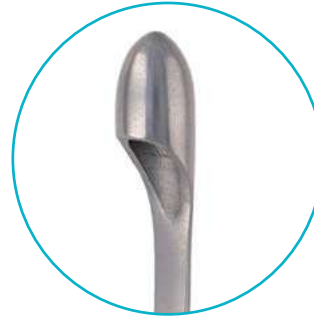

C381853
6 X 300 MM



C381854
7 X 300 MM



C381855
8 X 300 MM



C381856
9 X 300 MM

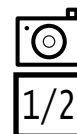
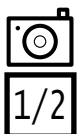

CURETTE CALCULS BILIAIRES DESJARDINS
4 X 280 MM EXPLORATEUR

C381857 *DESJARDINS GALLSTONE CURETTE
4 X 280 MM EXPLORER*

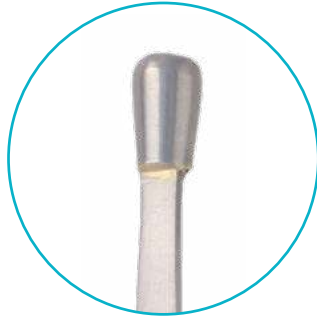

C381857
4 X 280 MM

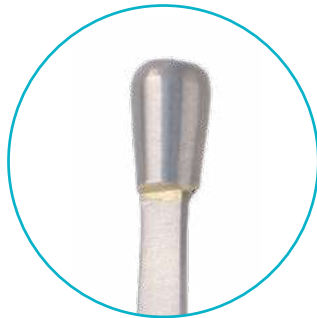

C381858
6 X 280 MM

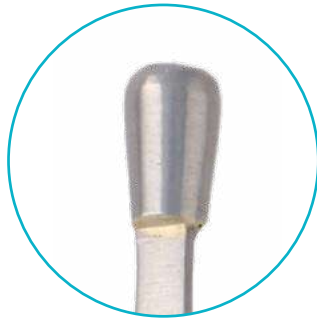

C381859
8 X 280 MM

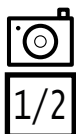

CURETTE CALCULS BILIAIRES
LUER KORTE 2,5 X 320 MM MALLEABLE
FIG 000

C381860 *LUER KORTE GALLSTONE CURETTE
2.5 X 320 MM MALLEABLE FIG 000*



C381861
FIG 00
3,2 X 320 MM

C381862
FIG 0
4,2 X 320 MM

C381863
FIG 1
5,5 X 320 MM

C381864
FIG 2
6,7 X 320 MM

C381865
FIG 3
8 X 320 MM

C381866
FIG 4
11 X 320 MM

C381867
FIG 5
15 X 320 MM





CURETTE CALCULS BILIAIRES

GALLSTONE CURETTE

CURETTE CALCULS BILIAIRES
MAYO 270 MM MALLEABLE
GRAND MODELE

C381868 *MAYO GALLSTONE CURETTE
270 MM LARGE MALLEABLE*

CURETTE CALCULS BILIAIRES MOYNIHAN 340 MM
MALLEABLE

C381870 *MOYNIHAN GALLSTONE CURETTE 340 MM
MALLEABLE*

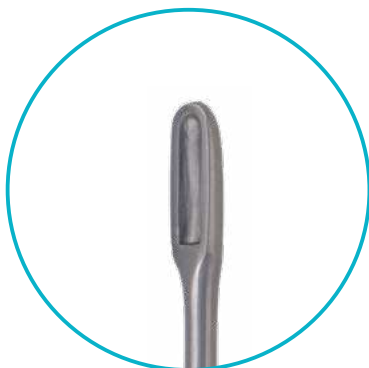

C381869

PETIT MODELE
SMALL

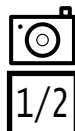
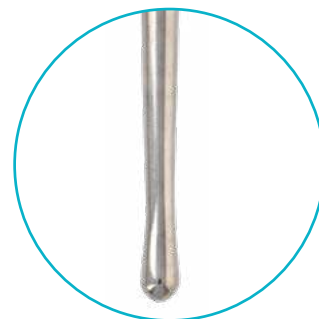

CURETTE CALCULS RENAUX

www.in-surg.fr



KIDNEY STONE CURETTE

CURETTE CALCUL RENAL CHEVASSU 4 X 280 MM MALLEABLE

C381872 KIDNEY STONE CURETTE CHEVASSU 4 X 280 MM MALLEABLE

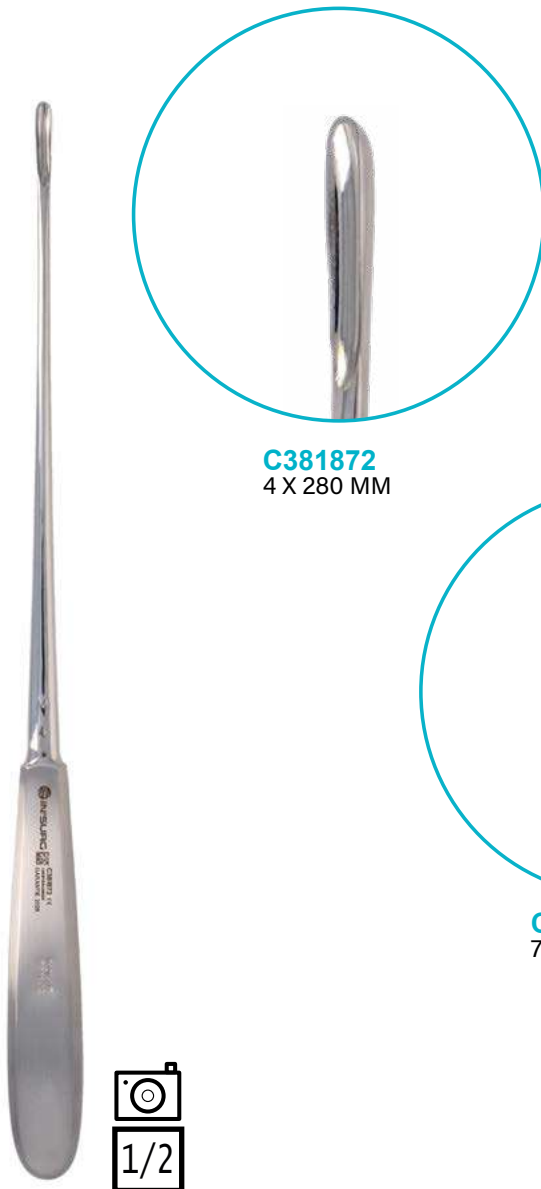

C381872
4 X 280 MM



C381873
7 X 280 MM



C381874
8 X 280 MM



CURETTE DERMATO BESNIER 2 X 135 MM FENETREE
C391876 *BESNIER DERMATO CURETTE 2 X 135 MM WINDOWED*

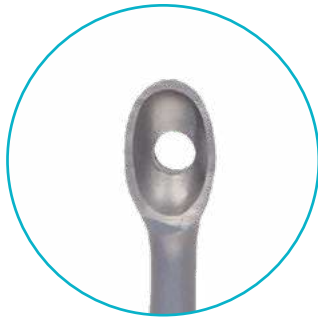

LONGUEUR LENGTH	
135 MM	
DIAMETRE DIAMETER	
1 MM	C391875
2 MM	C391876
3 MM	C391877
4 MM	C391878
5 MM	C391879
7 MM	C391880

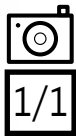

CURETTE DERMATO BESNIER 3 X 135 MM PLEINE
C391883 *BESNIER DERMATO CURETTE 3 X 135 MM FULL*



LONGUEUR LENGTH	
135 MM	
DIAMETRE DIAMETER	
1 MM	C391881
2 MM	C391882
3 MM	C391883
4 MM	C391884
5 MM	C391885
6 MM	C391886
7 MM	C391887

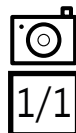

CURETTE DERMATO BROCK
5 X 145 MM

C391888 *BROCK DERMATO
CURETTE 5 X 145 MM*



CURETTE DERMATO BROCK
130 MM MOUSSE

C391889 *BROCK DERMATO
CURETTE 130 MM BLUNT*



CURETTE DERMATO VIDAL
130 MM TRCHANTE

C391890 *VIDAL DERMATO
CURETTE 130 MM SHARP*





CURETTE GYNECO 12 X 260 MM BORD DENTELE OU PIRON
C401891 *GYNECO CURETTE 12 X 260 MM SERRATED EDGE OR PIRON*

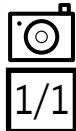

CURETTE GYNECO CUZZI 18 X 280 MM

C401892 CUZZI GYNECO CURETTE 18 X 280 MM

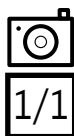

CURETTE GYNECO

GYNECO CURETTE

CURETTE GYNECO GOURDET 4 X 260 MM MOUSSE
C401893 *GOURDET GYNECO CURETTE 4 X 260 MM BLUNT*



DIAMETRE <i>DIAMETER</i>	LONGUEUR <i>LENGTH</i>
	260 MM
6 MM	C401894
8 MM	C401895
10 MM	C401896
12 MM	C401897
14 MM	C401898
16 MM	C401899

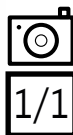

CURETTE GYNECO KEVORKIAN
4 X 315 MM BIOPSIE ENDO-UTERINE

C401900 KEVORKIAN GYNECO CURETTE
4 X 315 MM ENDOUTERINE
BIOPSY



CURETTE GYNECO KEVORKIAN 4 X 315 MM
AVEC PANIER BIOPSIE ENDO-UTERINE

C401901 KEVORKIAN GYNECO CURETTE 4 X 315 MM
ENDOUTERINE BIOPSY WITH BASKET





CURETTE GYNECO

GYNECO CURETTE

CURETTE GYNECO POZZI 8 x 260 MM SIMPLE

C401903 *POZZI GYNECO CURETTE 8 x 260 MM SINGLE*



C401902
6 X 260 MM

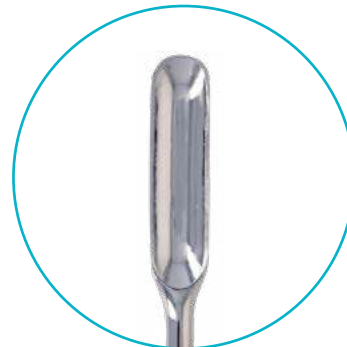

C401903
8 X 260 MM



CURETTE GYNECO RECAMIER 35 X 310 MM FAUX GERMES
C401904 *RECAMIER GYNECO CURETTE 35 X 310 MM OVUM*

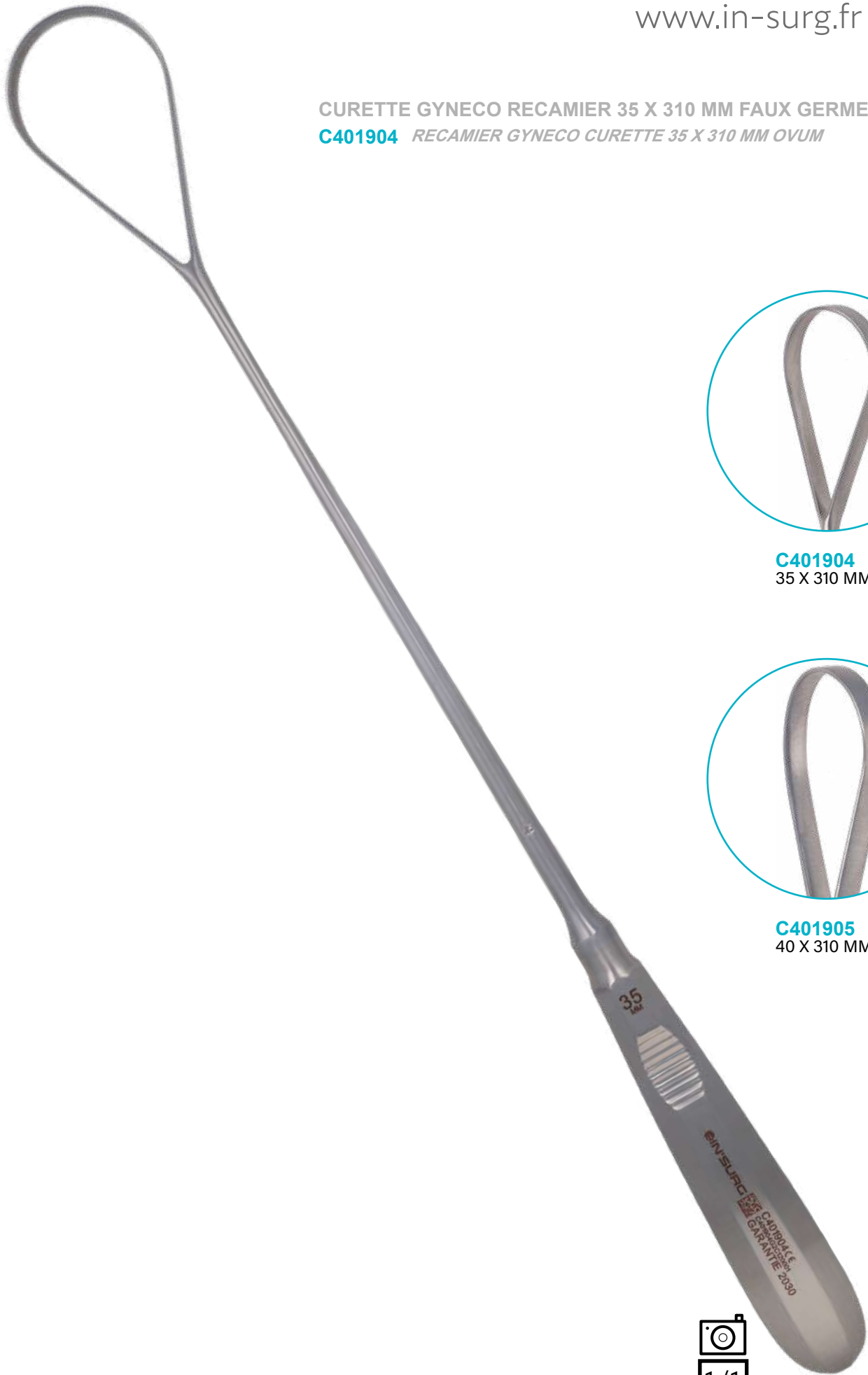

C401904
35 X 310 MM

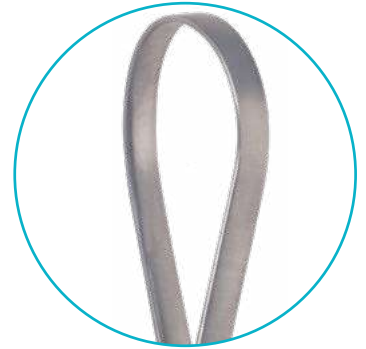

C401905
40 X 310 MM





CURETTE GYNECO

GYNECO CURETTE

CURETTE GYNECO RECAMIER 9 X 300 MM MOUSSE

C401906 RECAMIER GYNECO CURETTE 9 X 300 MM BLUNT

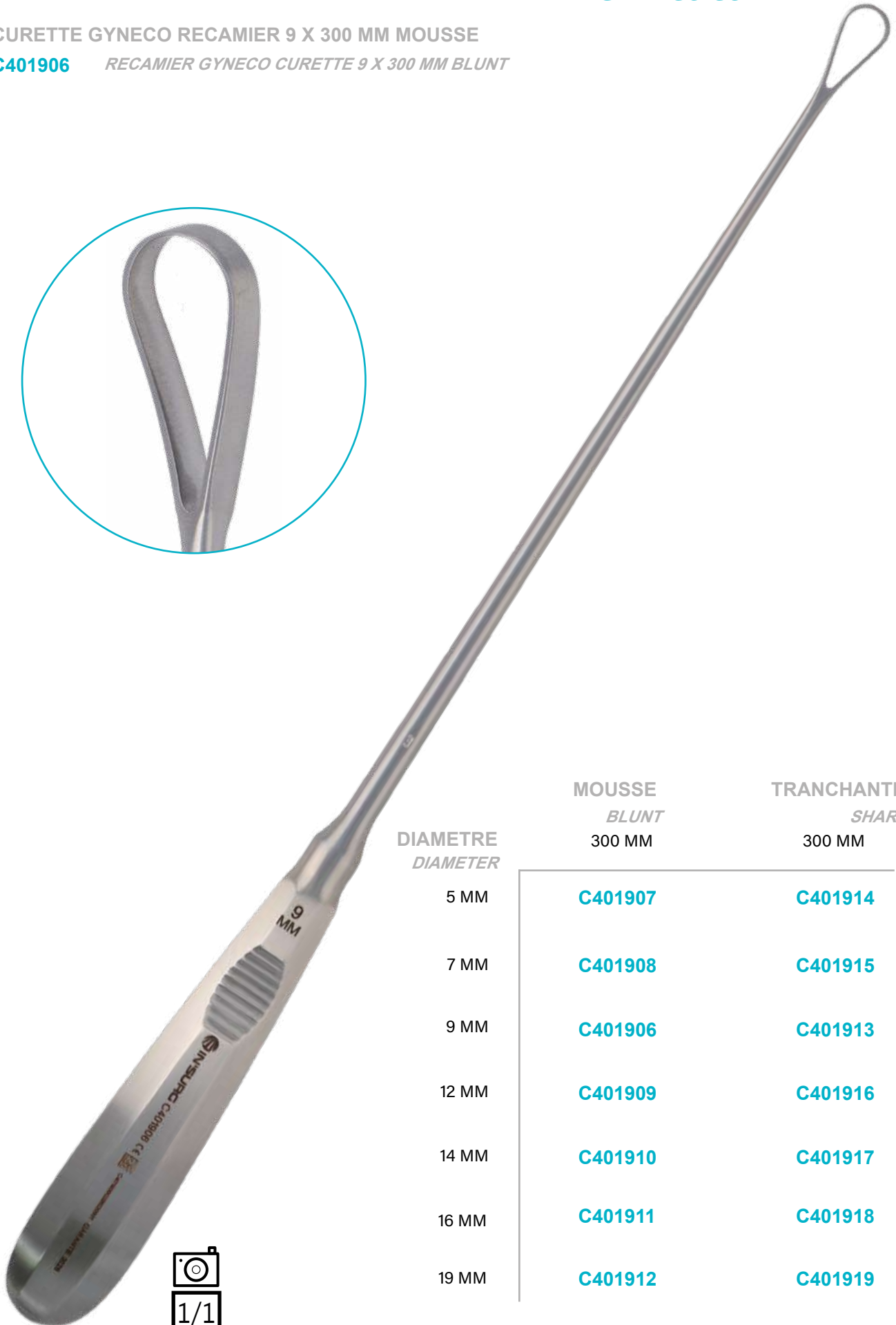

DIAMETRE
DIAMETER

MOUSSE
BLUNT
300 MM

TRACHANTE
SHARP
300 MM

- 5 MM
- 7 MM
- 9 MM
- 12 MM
- 14 MM
- 16 MM
- 19 MM

- C401907**
- C401908**
- C401906**
- C401909**
- C401910**
- C401911**
- C401912**

- C401914**
- C401915**
- C401913**
- C401916**
- C401917**
- C401918**
- C401919**

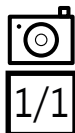

CURETTE GYNECO SCHRODER 7 X 300 MM TRANCHANTE
C401920 SCHRODER GYNECO CURETTE 7 X 300 MM SHARP



DIAMETRE DIAMETER	LONGUEUR LENGTH
7 MM	300 MM C401920
8.5 MM	C401921
10 MM	C401922
12 MM	C401923
13 MM	C401924
14 MM	C401925

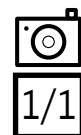

CURETTE GYNECO

GYNECO CURETTE

CURETTE GYNECO SIMON 4 X 270 MM TRANCHANTE
DOUBLE COURBURE

C401927 SIMON GYNECO CURETTE 4 X 270 MM SHARP
DOUBLE CURVATURE

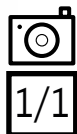

DIAMETRE DIAMETER	LONGUEUR LENGTH	
	270 MM	280 MM
4 MM	C401927	
6 MM	C401928	
8 MM		C401929
8,5 MM		C401930
10 MM		C401931
12 MM		C401932
14 MM		C401933
16 MM		C401934

CURETTE GYNECO SIMON 10 X 250 MM DROITE TRCHANTE
C401937 SIMON GYNECO CURETTE 10 X 250 MM STRAIGHT SHARP



DIAMETRE
DIAMETER

6 MM	C401942
7 MM	C401935
8,5 MM	C401936
10 MM	C401937
12 MM	C401938
13 MM	C401939
14 MM	C401940

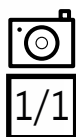

CURETTE GYNECO

GYNECO CURETTE

CURETTE GYNECO SIMS 6 X 275 MM
MOUSSE MALLEABLE

C401945 *SIMS GYNECO CURETTE 6 X 275 MM
BLUNT MALLEABLE*



DIAMETRE <i>DIAMETER</i>	MOUSSE <i>BLUNT</i>	TRCHANTE <i>SHARP</i>
	275 MM	280 MM
4 MM	C401943	C401951
5 MM	C401944	C401952
6 MM	C401945	C401953
7 MM	C401946	C401954
8 MM	C401947	C401955
8 MM	C401947	C401955
10 MM	C401948	C401956
12 MM	C401919	C401957
14 MM	C401950	C401958

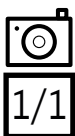



CURETTE GYNECO SIMS 6 X 280 MM RIGIDE TRCHANTE
C401966 *SIMS GYNECO CURETTE 6 X 280 MM HARD SHARP*

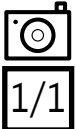
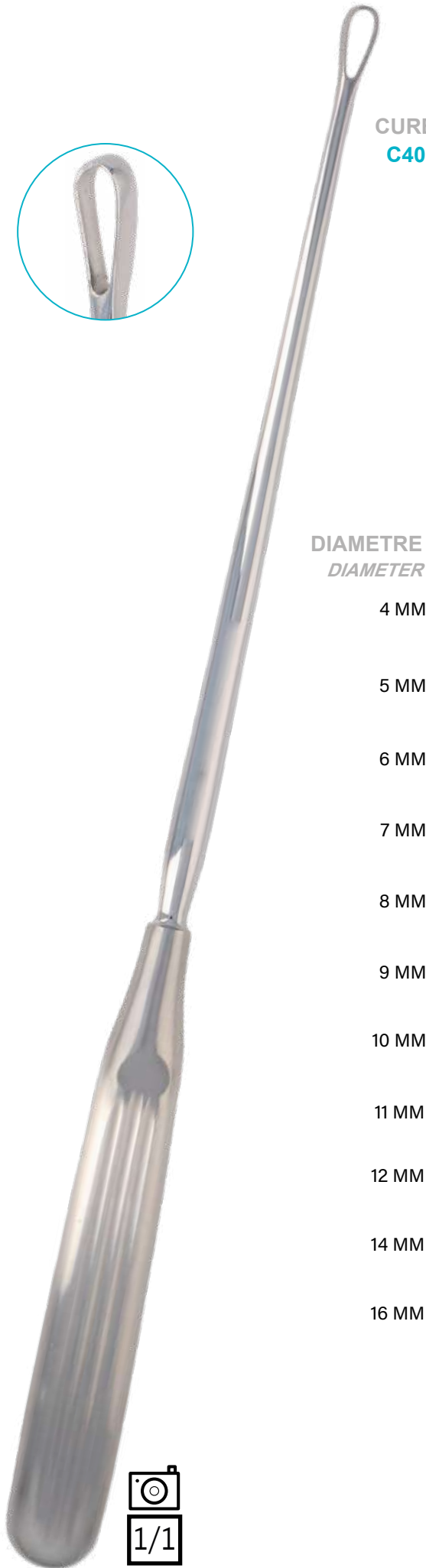

DIAMETRE DIAMETER	TRCHANTE SHARP	TRCHANTE SHARP	MOUSSE BLUNT
	275 MM	280 MM	275 MM
4 MM	C401974		
5 MM		C401965	
6 MM		C401966	
7 MM		C401967	C401959
8 MM		C401968	C401960
9 MM		C401970	
10 MM			C401961
11 MM		C401971	
12 MM		C401972	C401962
14 MM		C401973	C401963
16 MM	C401975		

CURETTE GYNECO

GYNECO CURETTE

CURETTE GYNECO SIMS 8 X 280 MM RIGIDE TRANCHANTE DENTELEE
C401969 SIMS GYNECO CURETTE 8 X 280 MM HARD SERRATED CUTTING EDGE



C401969
8 X 280 MM

C401964
11 X 280 MM



CURETTE GYNECO WALLICH 20 X 350 MM MOUSSE
C401983 WALLICH GYNECO CURETTE 20 X 350 MM BLUNT

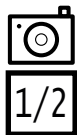

DIAMETRE DIAMETER	LONGUEUR LENGTH		
	300 MM	350 MM	400 MM
8 MM		C401978	
12 MM		C401979	C401984
14 MM	C401976	C401980	C401985
16 MM		C401981	
17 MM	C401977	C401982	C401986
20 MM		C401983	C401987



CURETTE NEURO

NEURO CURETTE

CURETTE NEURO FAHLBUSH
2,5 X 260 MM MALLEABLE

C411988 FAHLBUSH NEURO CURETTE
2,5 X 260 MM MALLEABLE



CURETTE NEURO FAHLBUSH
2,5 X 260 MM RIGIDE

C411989 FAHLBUSH NEURO CURETTE
2,5 X 260 MM RIGIDE

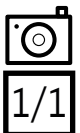
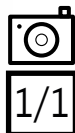

CURETTE NEURO HARDY
3 X 241 MM ANGULEE A DROITE A 45°

C411990 *HARDY NEURO CURETTE
3 X 241 MM RIGHT ANGLED 45°*



CURETTE NEURO HARDY
5 X 241 MM ANGULEE A GAUCHE A 45°

C411991 *HARDY NEURO CURETTE
5 X 241 MM LEFT ANGLED 45°*



ANGULEE 45°
ANGLED 45°
DIAMETRE
241 MM



ANGULEE 90°
ANGLED 90°
DIAMETRE
241 MM

DIAMETRE DIAMETER		ANGULEE 45° ANGLED 45°	ANGULEE 90° ANGLED 90°
A DROITE RIGHT	3 MM	C411990	C411992
A GAUCHE LEFT	5 MM	C411991	C411993

CURETTE NEURO

NEURO CURETTE

CURETTE NEURO HARDY 6 X 260 MM MALLEABLE

C412001 *HARDY NEURO CURETTE 6 X 260 MM MALLEABLE*



C412000
4 X 260 MM



C412001
6 X 260 MM

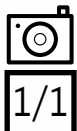

CURETTE NEURO LANDOLT 260 MM MALLEABLE
C412002 LANDOLT NEURO CURETTE 260 MM MALLEABLE



C412002
260 MM



C412004
2,2 X 260 MM



C412003
260 MM EN CUILLERE
SPOON FORM

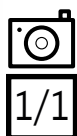

CURETTE NEURO

NEURO CURETTE

CURETTE NEURO NICOLA 6,5 X 215 MM
COUDEE MALLEABLE

C412009 NICOLA NEURO CURETTE
6,5 X 215 MM ANGLED
MALLEABLE

CURETTE NEURO YASARGIL 185 MM
TRANCHANTE

C412010 YASARGIL NEURO CURETTE
185 MM SHARP



C412007
COUPE A DROITE
RIGHT HANDCUT

C412008
COUPE A GAUCHE
LEFT HANDCUT

C412003
260 MM EN CUILLERE
SPOON FORM

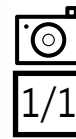
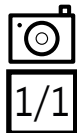

E.N.T CURETTE

CURETTE ORL BLONDIAU 20 X 240 MM AMYGDALES
C422013 BLONDIAU ENT CURETTE 20 X 240 MM TONSILS





CURETTE ORL BRUGIRARD A DROITE

C422014 BRUGIRARD ENT CURETTE RIGHT

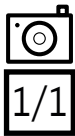

DROITE
STRAIGHT

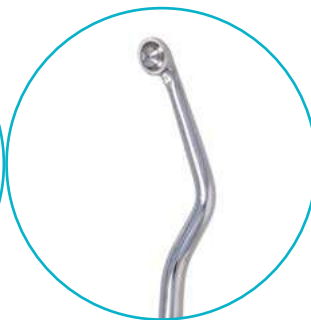

COUDE A GAUCHE
LEFT ANGLED



COUDE A DROITE
RIGHT ANGLED

LONGUEUR
LENGTH

215 MM

C422016

C422015

C422014

CURETTE ORL BUCK 2 X 165 MM MOUSSE AURICULAIRE

C422021 BUCK ENT CURETTE 2 X 165 MM BLUNT EAR



DIAMETRE <i>DIAMETER</i>	MOUSSE <i>BLUNT</i>	TRCHANTE <i>SHARP</i>
	165 MM	165 MM
1 MM	C422018	
1,5 MM	C422017	C422020
2 MM	C422021	C422022
2,5 MM	C422023	C422024
3 MM	C422025	C422026
3,5 MM	C422027	C422028
4 MM	C422029	C422030
4,5 MM	C422031	C422032
5 MM	C422033	C422034

CURETTE ORL CHATELLIER 3 X 140 MM FENETREE

C422045 CHATELLIER ENT CURETTE 3 X 140 MM WINDOWED

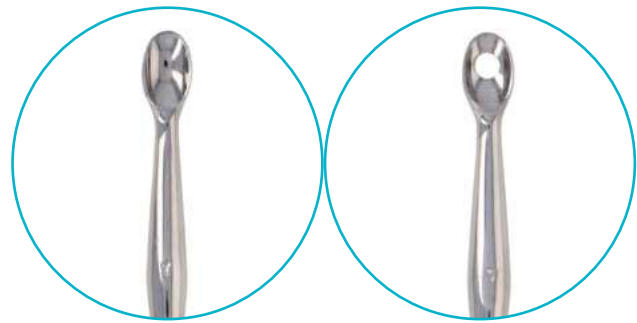
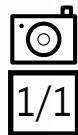

DIAMETRE DIAMETER	PLEINE FULL	FENETREE WINDOWED
	140 MM	140 MM
3 MM	C422048	C422045
5 MM	C422049	C422046
7 MM	C422050	C422047

CURETTE ORL CHOMPRET 3 X 150 MM DROITE

C422053 *CHOMPRET ENT CURETTE 3 X 150 MM STRAIGHT*

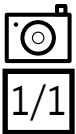

DROITE
STRAIGHT



COUDE A GAUCHE
LEFT ANGLED



COUDE A DROITE
RIGHT ANGLED

LONGUEUR
LENGTH
150 MM

C422053	C422052	C422051
----------------	----------------	----------------

CURETTE O.R.L

E.N.T CURETTE

CURETTE ORL HOUSE 1 X 1,2 X 150 MM
 DROITE AURICULAIRE DOUBLE
C422055 HOUSE ENT CURETTE 1 X 1.2 X 150 MM
 STRAIGHT EAR DOUBLE

CURETTE ORL JANSEN 2 - 4 X 150 MM
 DOUBLE
C422056 JANSEN ENT CURETTE 2 - 4 X 150 MM
 DOUBLE



CURETTE ORL LEMPERS 2,7 X 210 MM FIGURE 00000 AURICULAIRE

C422061 LEMPERS ENT CURETTE 2,7 X 210 MM EAR FIG 00000

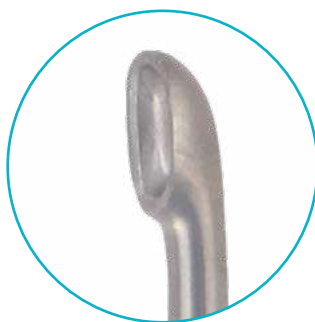

DIAMETRE <i>DIAMETER</i>	LONGUEUR <i>LENGTH</i>	FIGURE
	210 MM	
1,5 MM	C422057	0
2 MM	C422058	00
2,2 MM	C422059	000
2,5 MM	C422060	0000
2,7 MM	C422061	00000
3 MM	C422062	1

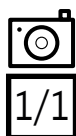

CURETTE O.R.L

E.N.T CURETTE

CURETTE ORL LIMA
3 X 270 MM SINUS

C422063 LIMA ENT CURETTE
3 X 270 MM SINUS



C422064
5 X 270 MM

C422065
7 X 270 MM

CURETTE ORL LUC 10 X 175 MM DROITE

C422068 LUC ENT CURETTE 10 X 175 MM
STRAIGHT



C422066
10 X 175 MM
COUDEE A DROITE
RIGHT ANGLED



C422067
10 X 175 MM
COUDEE A GAUCHE
LEFT ANGLED

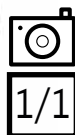
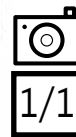

CURETTE ORL MEYHOFER 2 X 130 MM

C422070 MEYHOFER ENT CURETTE 2 X 130 MM



C422069
0,5 X 130 MM

C422071
2,5 X 130 MM

C422072
3,5 X 130 MM

C422073
4 X 130 MM

C422074
4,5 X 130 MM

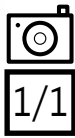

CURETTE ORL MOURE 5 X 180 MM DROITE SINUS

C422079 MOURE ENT CURETTE 5 X 180 MM STRAIGHT SINUS



C422079
5 X 180 MM DROITE
RIGHT



C422077
5 X 180 MM
COUDEE A DROITE SINUS
RIGHT ANGLED



C422078
5 X 180 MM
COUDEE A GAUCHE SINUS
LEFT ANGLED



CURETTE ORL MOURE 7 X 250 MM ETHMOIDALE

C422075 MOURE ENT CURETTE 7 X 250 MM ETHMOIDALE



Garantie totale
5 ANS
sans conditions

C422076
9 X 250 MM

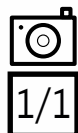

CURETTE ORL SEBILEAU
5 X 210 MM DEMIE COURBE SINUS

C422080 SEBILEAU ENT CURETTE
5 X 210 MM DEMI CURVED SINUS



C422081
6 X 210 MM

C422082
7 X 210 MM



CURETTE ORL SEBILEAU
5 X 210 MM COURBE SINUS

C422083 SEBILEAU ENT CURETTE
5 X 210 MM CURVED SINUS



C422084
6 X 210 MM

C422085
7 X 210 MM



CURETTE OSSEUSE

BONE CURETTE

CURETTE OSSEUSE BRUNS VOLKMANN 11,8 X 170 MM

C432093 VOLKMANN BRUNS BONE CURETTE 11,8 X 170 MM



DIAMETRE DIAMETER	LONGUEUR LENGTH 170 MM
2,6 MM	C432086
3,3 MM	C432087
4,8 MM	C432088
5,8 MM	C432089
7,3 MM	C432090
8,3 MM	C432091
10,2 MM	C432092
11,8 MM	C432093
12,8 MM	C432094
14 MM	C432095

CURETTE OSSEUSE BRUNS 2 X 230 MM ANGULEE A 45° FIG 6/0

C432096 BRUNS BONE CURETTE 2 X 230 MM ANGLED 45° FIG 6/0

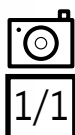

DIAMETRE <i>DIAMETER</i>	LONGUEUR <i>LENGTH</i>	
	230 MM	FIGURE
2 MM	C432096	6/0
2,2 MM	C432097	5/0
2,5 MM	C432098	4/0
3,3 MM	C432099	00
3,7 MM	C432100	0
4,3 MM	C432101	1
4,8 MM	C432102	2
6,1 MM	C432103	4
6,7 MM	C432104	5
8,7 MM	C432105	6

CURETTE OSSEUSE BRUNS 4,8 X 230 MM DROITE FIG 2
C432112 BRUNS BONE CURETTE 4,8 X 230 MM STRAIGHT FIG 2



DIAMETRE <i>DIAMETER</i>	LONGUEUR <i>LENGTH</i>	
	230 MM	FIGURE
2 MM	C432106	6/0
2,3 MM	C432107	5/0
2,5 MM	C432108	4/0
3,3 MM	C432109	00
3,7 MM	C432110	0
4,3 MM	C432111	1
4,8 MM	C432112	2
6,1 MM	C432113	4
6,7 MM	C432114	5
8,7 MM	C432115	6

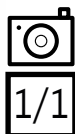

CURETTE OSSEUSE BRUNS 2,5 X 230 MM FIG 00 MANCHE HEXAGONALE

C432118 BRUNS BONE CURETTE 2,5 X 230 MM FIG 00 HEXAGONAL HANDLE

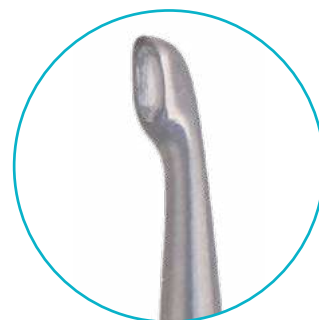
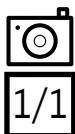

DIAMETRE DIAMETER	LONGUEUR LENGTH	
	230 MM	FIGURE
1,5 MM	C432116	0000
2 MM	C432117	000
2,5 MM	C432118	00
3,3 MM	C432119	0
3,7 MM	C432120	1
4,3 MM	C432121	2
4,8 MM	C432122	3
6,1 MM	C432123	4
6,7 MM	C432124	5
8,8 MM	C432125	6



CURETTE OSSEUSE BRUNS 3 X 280 MM COUDEE MANCHE HEXAGONALE

C432127 BRUNS BONE CURETTE 3 X 280 MM ANGLED HEXAGONAL HANDLE

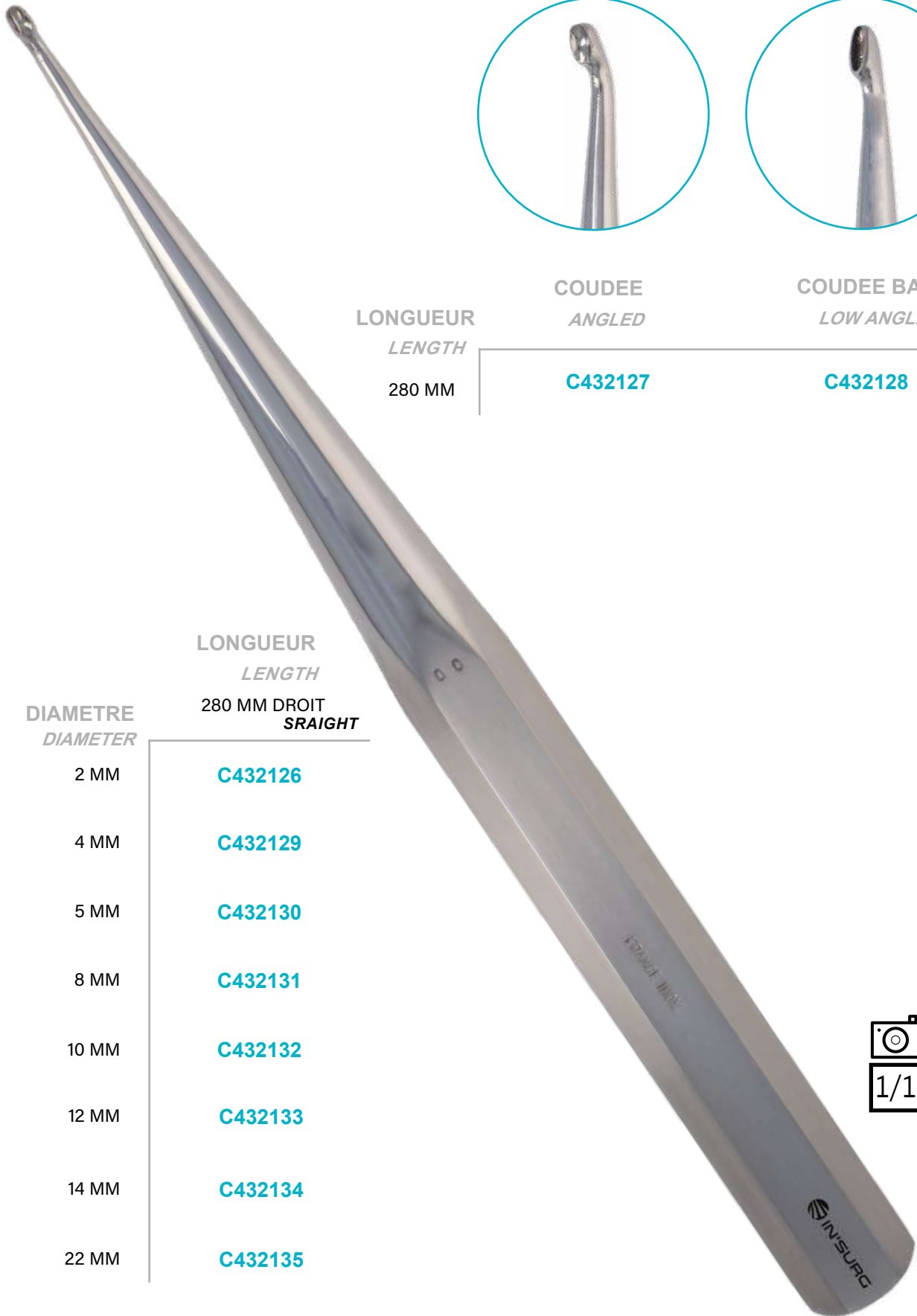

COUDEE
ANGLED

COUDEE BAS
LOW ANGLED

LONGUEUR
LENGTH

280 MM

C432127

C432128

LONGUEUR
LENGTH

280 MM DROIT
STRAIGHT

DIAMETRE
DIAMETER

2 MM

C432126

4 MM

C432129

5 MM

C432130

8 MM

C432131

10 MM

C432132

12 MM

C432133

14 MM

C432134

22 MM

C432135



CURETTE OSSEUSE CASPAR 3 X 270 MM CONTRE COUDEE DENTEE
C432137 CASPAR BONE CURETTE 3 X 270 MM SERRATED COUNTER ANGLED



CURETTE OSSEUSE CASPAR 4,4 X 220 MM COUDEE

C432139 CASPAR BONE CURETTE 4,4 X 220 MM ANGLED



DROITE
STRAIGHT



COUDEE
ANGLED

DIAMETRE
DIAMETER

3,6 MM

4,4 MM

5,2 MM

LONGUEUR
LENGTH

220 MM

220 MM

C432141

C432138

C432142

C432139

C432143

C432140

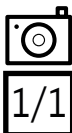

CURETTE OSSEUSE CAUCHOIX 8 X 260 MM CONTRE COUDEE
C432144 CAUCHOIX BONE CURETTE 8 X 260 MM COUNTER ELBOW



CURETTE OSSEUSE CHARNLEY 8 X 380 MM
C432145 CHARNLEY BONE CURETTE 8 X 380 MM

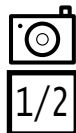
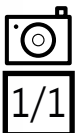

DIAMETRE DIAMETER	LONGUEUR LENGTH	
	380 MM	400 MM
6 MM		C432146
8 MM	C432145	
10 MM		C432147
12 MM		C432148
18 MM		C432149

CURETTE OSSEUSE

BONE CURETTE

CURETTE OSSEUSE CLOVIS VINCENT
3 - 4 X 200 MM DOUBLE MALLEABLE

C432154 CLOVIS VINCENT BONE CURETTE
3 - 4 X 200 MM DOUBLE MALLEABLE



C432155
5 - 6 X 200 MM

C432156
7 - 8 X 200 MM

C432157
9 - 10 X 200 MM

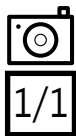

CURETTE OSSEUSE CLOVIS VINCENT
1 - 2 X 200 MM DOUBLE RIGIDE

C432158 CLOVIS VINCENT BONE CURETTE
1 - 2 X 200 MM DOUBLE RIGIDE



C432159
2 - 3 X 200 MM

C432160
3 - 4 X 200 MM

C432161
4 - 5 X 200 MM

C432162
5 - 6 X 200 MM

C432163
6 - 7 X 200 MM

C432164
7 - 8 X 200 MM

C432165
9 - 10 X 200 MM

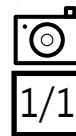

CURETTE OSSEUSE CLOWARD 3,3 X 200 MM DROITE FIGURE 00

C432180 CLOWARD BONE CURETTE 3,3 X 200 MM STRAIGHT FIGURE 00

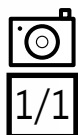
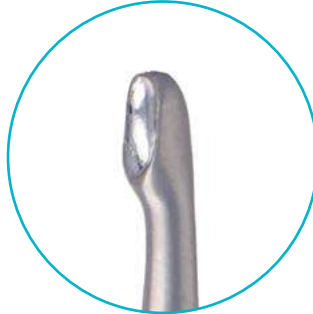

DIAMETRE <i>DIAMETER</i>	LONGUEUR <i>LENGTH</i>	
	200 MM	FIGURE
2 MM	C432178	6/0
2,8 MM	C432179	000
3,3 MM	C432180	00
3,7 MM	C432181	0
4,3 MM	C432182	1
4,8 MM	C432183	2
6,1 MM	C432184	4
6,7 MM	C432185	5
8,7 MM	C432186	6

CURETTE OSSEUSE CLOWARD 2,8 X 200 MM ANGULEE A 45° FIGURE 000

C432167 *CLOWARD BONE CURETTE 2,8 X 200 MM ANGLED 45° FIGURE 000*



ANGULEE A 45°
ANGLED AT 45°



CONTRE COUDEE
COUNTER ANGLED

DIAMETRE
DIAMETER

200 MM

200 MM

FIGURE

2 MM

C432166

6/0

2,5 MM

C432175

2,8 MM

C432167

C432176

000

3,3 MM

C432168

C432177

00

3,7 MM

C432169

0

4,3 MM

C432170

1

4,8 MM

C432171

2

6,1 MM

C432172

4

6,7 MM

C432173

5

8,7 MM

C432174

6

CURETTE OSSEUSE COBB 8.5 X 280 MM
C432194 *COBB BONE CURETTE 8.5 X 280 MM*



DIAMETRE <i>DIAMETER</i>	LONGUEUR <i>LENGTH</i>
2 MM	280 MM C432187
2,5 MM	C432188
3 MM	C432189
3,5 MM	C432190
4,5 MM	C432191
5,5 MM	C432192
7,5 MM	C432193
8,5 MM	C432194
10 MM	C432195

CURETTE OSSEUSE

BONE CURETTE

CURETTE OSSEUSE DAUBENSPECK
6 X 200 MM COUDEE

C432199 *DAUBENSPECK BONE CURETTE
6 X 200 MM ANGLED*

CURETTE OSSEUSE HALLE 5 X 210 MM
TRANCHANTE MALLEABLE

C432202 *HALLE BONE CURETTE 5 X 210 MM
SHARP MALLEABLE*



CURETTE OSSEUSE SCHEDE 2,5 X 170 MM DROITE
C432205 SCHEDE BONE CURETTE 2,5 X 170 MM STRAIGHT





CURETTE OSSEUSE 5 X 230 MM COUDEE PR SCIATIQUE

C432212 BONE CURETTE 5 X 230 MM ANGLED FOR SCIATICS



DIAMETRE
DIAMETER

COUDEE
ANGLED

DROITE
STRAIGHT

5 MM

C432212

C432214

7 MM

C432213

C432215

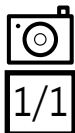



CURETTE OSSEUSE SCOVILLE 250 MM DROITE
C432218 *BONE CURETTE SCOVILLE 250 MM STRAIGHT*



DROITE
STRAIGHT



COUDEE AVANT
ANGLED FORWARD



COUDEE ARRIERE
ANGLED BACKWARD

LONGUEUR
LENGTH
 250 MM

C432218

C432217

C432216

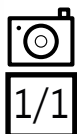



CURETTE OSSEUSE SEMMES 4 & 7 X 230 MM COURBE

C432219 BONE CURETTE SEMMES 4 & 7 X 230 MM CURVED



C432219
4 & 7 X 230 MM COURBE
CURVED



C432220
4 & 7 X 230 MM DROITE
STRAIGHT

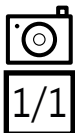

CURETTE OSSEUSE SPRATT 2 X 160 MM DROITE

C432221 BONE CURETTE SPRATT 2 X 160 MM STRAIGHT

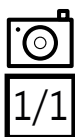

DIAMETRE DIAMETER	LONGUEUR LENGTH 160 MM
2 MM	C432221
3 MM	C432222
3,5 MM	C432223
4 MM	C432224
4,5 MM	C432225

CURETTE OSSEUSE

BONE CURETTE

CURETTE OSSEUSE 4,4 X 250 MM
DROITE TRANCHANTE

C432231 BONE CURETTE 4,4 X 250 MM
STRAIGHT SHARP



C432230
3,6 X 250 MM

C432232
5,2 X 250 MM

C432233
6 X 250 MM

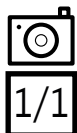

1/1

CURETTE OSSEUSE 10 X 270 MM DROITE
TRANCHANTE MANCHE LEGER

C432235 BONE CURETTE 10 X 270 MM
STRAIGHT SHARP LIGHT HANDLE



C432236
4 X 270 MM

C432237
6 X 270 MM

C432234
8 X 270 MM

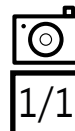

1/1

CURETTE OSSEUSE VOLKMANN 4 X 170 MM
C432241 VOLKMANN BONE CURETTE 4 X 170 MM



DIAMETRE DIAMETER	LONGUEUR LENGTH				
	170 MM	200 MM	240 MM	280 MM	460 MM
1 MM	C432238				
2 MM	C432239	C432250			
3 MM	C432240	C432251			
4 MM	C432241	C432252	C432261	C432268	
5 MM	C432242	C432253	C432262		
6 MM	C432243	C432254	C432263	C432272	C432283
7 MM	C432244	C432255			
8 MM	C432245	C432256	C432264	C432276	C432284
10 MM	C432246	C432257	C432265	C432277	C432285
12 MM	C432247	C432258	C432266	C432278	C432286
14 MM	C432248	C432259	C432267	C432279	
16 MM	C432249	C432260		C432280	
18 MM				C432281	
20 MM				C432282	

CURETTE OSSEUSE

BONE CURETTE

CURETTE OSSEUSE VOLKMANN 6 X 280 MM DENTELEE
C432275 VOLKMANN BONE CURETTE 6 X 280 MM SERRATED

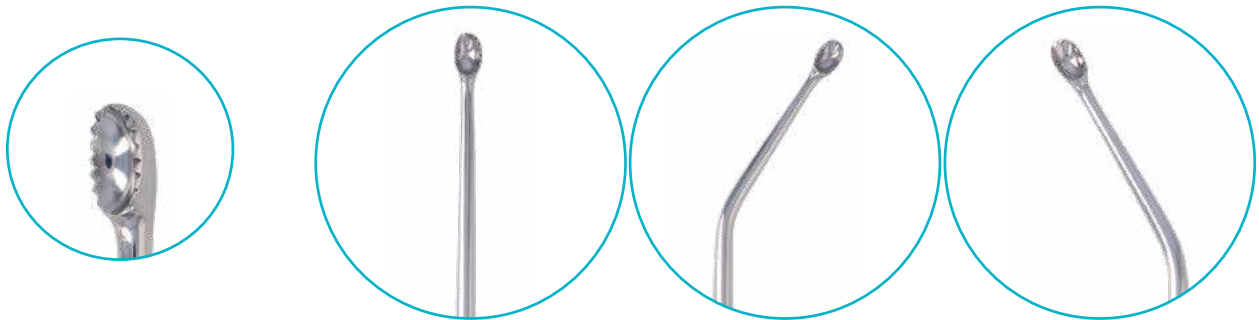

DIAMETRE DIAMETER	DROITE STRAIGHT	COUDEE A DROITE RIGHT ANGLED	COUDEE A GAUCHE LEFT ANGLED
5,5 MM	C432269	C432270	C432271
6 MM	C432275	C432273	C432274

CURETTE OSSEUSE WILLIGER 3 - 3,5 X 135 MM DOUBLE
C432292 WILLIGER DUAL BONE CURETTE 3 - 3,5 X 135 MM



C432291
2.5 - 3 X 135 MM

C432293
3.5 - 4 X 135 MM



CURETTE OSSEUSE VOLKMANN 6 - 8 X 160 MM
DOUBLE

C432289 VOLKMANN DUAL BONE CURETTE
6 - 8 X 160 MM



C432287
6 - 5 X 130 MM

C432288
6 - 7 X 130 MM

C432290
10 - 11 X 200 MM



CURETTE OSSEUSE VOLKMANN
CURETTE OVALE 8 MM - RONDE 9 MM
X 200 MM DOUBLE

C432294 VOLKMANN DUAL CURETTE 200 MM
CURETTE OVAL 8 MM ROUND 9 MM

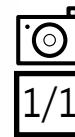

SOMMAIRE

DAVIER	435
<i>BONE HOLDING FORCEPS</i>	
DECOLLEUR	456
<i>BREAKER</i>	
DERMATOME	458
<i>DERMATOME</i>	
DILATATEUR :	
NEURO	459
<i>NEURO DILATATOR</i>	
RECTAL	460
<i>RECTAL DILATATOR</i>	
TRACHEAL	466
<i>TRACHEAL DILATATOR</i>	
VASCULAIRE	468
<i>VASCULAR DILATATOR</i>	
VOIES BILIAIRES	470
<i>GALL DUCT DILATATOR</i>	
DISSECTEUR	471
<i>DISSECTOR</i>	



D

RETRO 'SPECTIVE

Jean DAUSSET
(19 octobre 1916 - 6 juin 2009)

effectua , après la guerre, des recherches sur **la transfusion sanguine**. Il découvre **le complexe majeur d'histocompatibilité** et devient Président-fondateur de l'association France Transplant puis crée une fondation qui travaille intensivement au **décryptage du génome humain**.

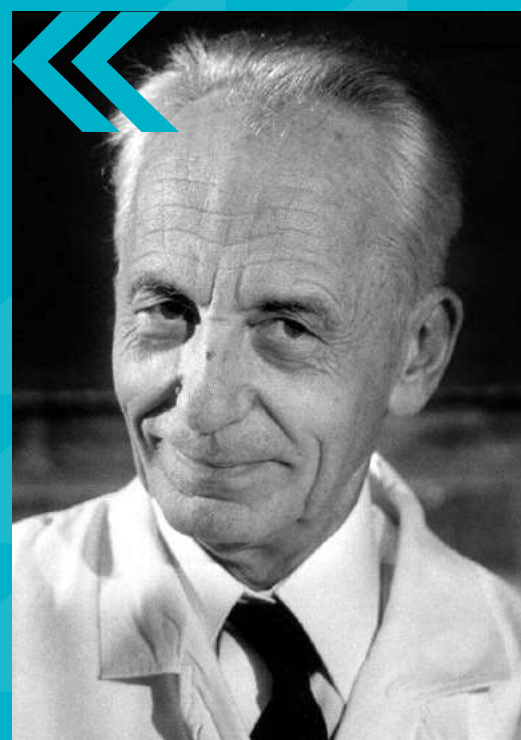

DAVIER

**BONE HOLDING
FORCEPS**

DAVIER BIRCHER GANSK 200 MM AVEC CREMAILLERE
D012294 *BIRCHER GANSK BONE HOLDING FORCEPS 200 MM
WITH RATCHET*



DAVIER DINGMANN 190 MM

D012295 DINGMANN BONE HOLDING FORCEPS 190 MM



DAVIER

BONE HOLDING FORCEPS

DAVIER FARABEUFF 170 MM AVEC CREMAILLERE
D012296 FARABEUFF BONE HOLDING FORCEPS 170 MM
 WITH RATCHET

DAVIER FARABEUFF 170 MM SANS CREMAILLERE
D012299 FARABEUFF BONE HOLDING FORCEPS 170 MM
 WITHOUT RATCHET



D012297
190 MM

D012298
260 MM

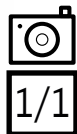

D012300
190 MM

D012301
260 MM

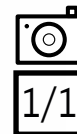

DAVIER KERN LANE 150 MM AVEC CREMAILLERE

D012302 KERN LANE BONE HOLDING FORCEPS
150 MM WITH RATCHET



D012303
170 MM

D012304
210 MM

DAVIER KERN LANE 150 MM SANS CREMAILLERE

D012305 KERN LANE BONE HOLDING FORCEPS
150 MM WITHOUT RATCHET



D012306
170 MM

D012307
210 MM

DAVIER

BONE HOLDING FORCEPS

DAVIER LAMBOTTE 220 MM DROIT
A CREMAILLERE

D012310 LAMBOTTE BONE HOLDING FORCEPS
220 MM STRAIGHT WITH RATCHET

DAVIER LAMBOTTE 220 MM EN S
A CREMAILLERE

D012313 LAMBOTTE BONE HOLDING FORCEPS
220 MM S FORM WITH RATCHET



D012311
260 MM

D012312
330 MM



D012314
260 MM

D012315
330 MM

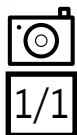
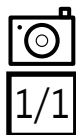

DAVIER LANE 450 MM AVEC CREMAILLERE
D012317 LANE BONE HOLDING FORCEPS 450 MM
WITH RATCHET

DAVIER LANE 450 MM SANS CREMAILLERE
D012319 LANE BONE HOLDING FORCEPS 450 MM
WITHOUT RATCHET



D012316
330 MM

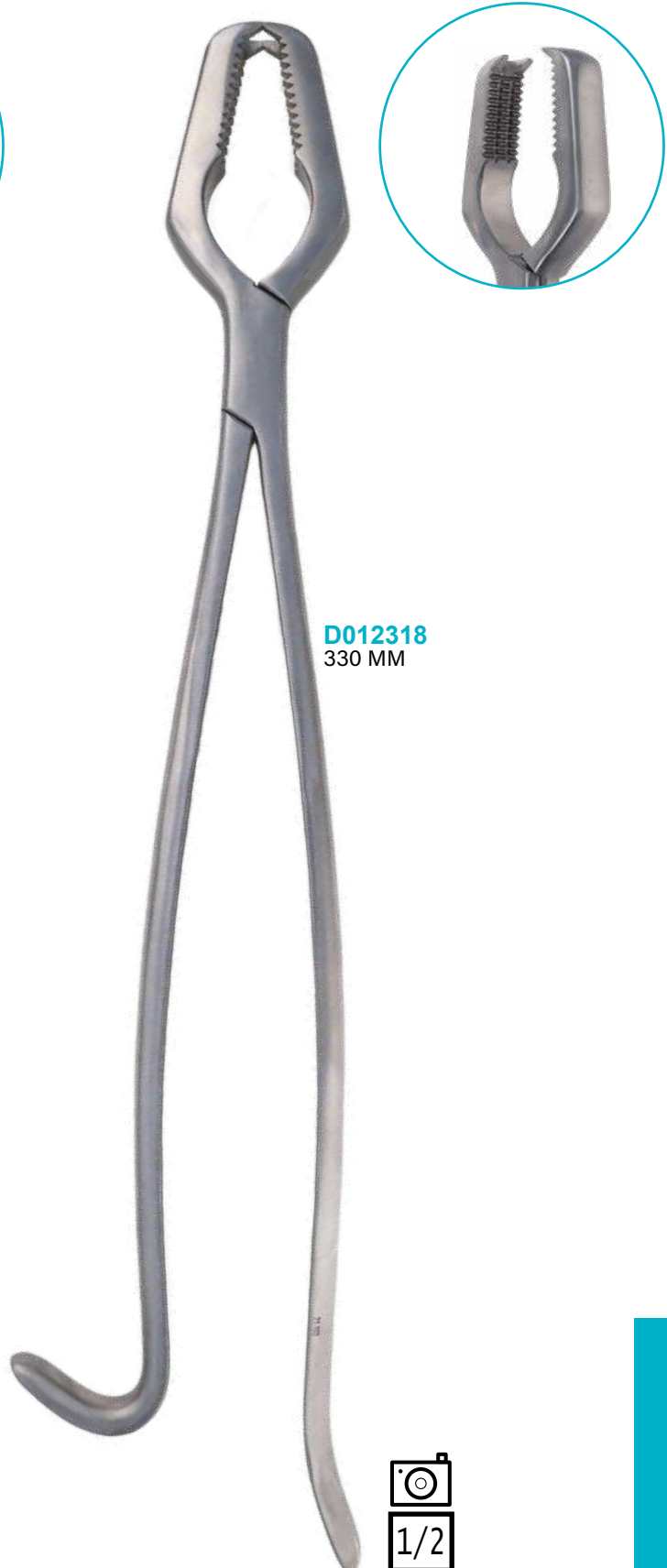

D012318
330 MM

DAVIER

BONE HOLDING FORCEPS

DAVIER LANGENBECK MORS 11 MM X 205 MM

D012320 LANGENBECK BONE HOLDING FORCEPS
11 X 205 MM

DAVIER LEWIN 170 MM

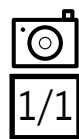
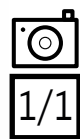
D012321 LEWIN BONE HOLDING FORCEPS
170 MM



DAVIER LOWMAN 200 MM
D012323 LOWMAN BONE HOLDING FORCEPS 200 MM

D012322
180 MM

D012324
220 MM

D012325
180 MM 1 X 1 GRIFFE
1 X 1 TOOTH

REDUCTEUR POUR DAVIER DE LOWMAN
D012326 REDUCTANT FOR LOWMAN BONE HOLDING FORCEPS



DAVIER

DAVIER OS MALLEOLE 210 MM
D012327 BONE HOLDING FORCEPS 210 MM
 MALLEOLE

BONE HOLDING FORCEPS

DAVIER OLLIER 190 MM A CREMAILLIERE
 POUR ROTULE

D012332 OLLIER BONE HOLDING FORCEPS 190 MM
 WITH RATCHET FOR KNEECAP



D012333
 220 MM

D012334
 270 MM



DAVIER 150 MM PREHENSEUR
PETITS FRAGMENTS

D012335 BONE HOLDING FORCEPS 150 MM
GRASPER FOR SMALL FRAGMENTS



DAVIER 135 MM REDUCTEUR PETITS OS

D012336 BONE HOLDING FORCEPS 135 MM
REDUCTANT FOR SMALL BONE



DAVIER 200 MM REDUCTEUR POUR GENOUX

D012337 BONE HOLDING FORCEPS 200 MM REDUCTANT FOR KNEES



DAVIER 190 MM RESECTION

D012338 BONE HOLDING FORCEPS 190 MM RESECTION

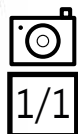

DAVIER 250 MM DELICAT RESECTION

D012339 BONE HOLDING FORCEPS 250 MM DELICATE RESECTION

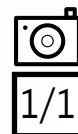

DAVIER

BONE HOLDING FORCEPS

DAVIER ROWE 230 MM A DROITE

D012340 ROWE BONE HOLDING FORCEPS 230 MM ON THE RIGHT**D012340**
230 MM - DROITE
RIGHT**D012341**
230 MM - GAUCHE
LEFT

PIECE CONNECTION POUR DAVIER ROWE

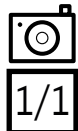
D012342 CONNECTION PIECE FOR ROWE BONE HOLDING FORCEPS

DAVIER SEMB 200 MM AVEC CREMAILLERE

D012344 SEMB BONE HOLDING FORCEPS 200 MM WITH RATCHET

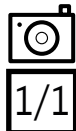

DAVIER SEMB 200 MM SANS CREMAILLERE

D012345 SEMB BONE HOLDING FORCEPS 200 MM WITHOUT RATCHET

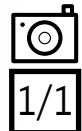

DAVIER

BONE HOLDING FORCEPS

DAVIER SEQUESTRE 200 MM COURBE
D012346 SEQUESTRE BONE HOLDING
 FORCEPS 200 MM CURVED

DAVIER SEQUESTRE 200 MM DROIT
D012347 SEQUESTRE BONE HOLDING
 FORCEPS 200 MM STRAIGHT

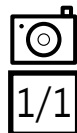

DAVIER SETTER 170 MM AVEC SYSTÈME D'ARRET

D012348 SETTER BONE HOLDING FORCEPS 170 MM WITH START-STOP



D012349
235 MM



DAVIER SETTER 145 MM REDUCTEUR

D012350 SETTER BONE HOLDING FORCEPS 145 MM REDUCTANT

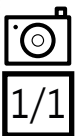

DAVIER

BONE HOLDING FORCEPS

DAVIER ULRICH 180 MM PETIT MODELE

D012351 *ULRICH BONE HOLDING
FORCEPS 180 MM SMALL MODEL*

DAVIER ULRICH ST GALLEN 280 MM A VIS

D012352 *ULRICH ST GALLEN BONE
HOLDING FORCEPS 280 MM
SCREW*

DAVIER VAN BUREN 220 MM COURBURE LATÉRALE

D012353 VAN BUREN BONE HOLDING FORCEPS 220 MM LATÉRALE CURVATURE

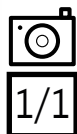

DAVIER

BONE HOLDING FORCEPS

DAVIER VERBRUGGE 150 MM PREHENSEUR
D012360 VERBRUGGE BONE HOLDING
 FORCEPS 150 MM GRASPER

DAVIER VERBRUGGE 150 MM REDUCTEUR
D012370 VERBRUGGE BONE HOLDING
 FORCEPS 150 MM REDUCTANT

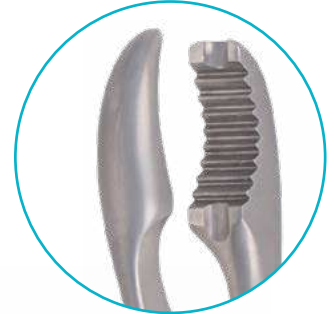

- D012361**
180 MM
- D012362**
240 MM
- D012363**
260 MM
- D012364**
280 MM



- D012371**
180 MM
- D012372**
240 MM
- D012373**
260 MM
- D012374**
280 MM

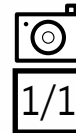

DAVIER VERBRUGGE 160 MM PREHENSEUR
POUR MAIN

D012357 VERBRUGGE BONE HOLDING
FORCEPS 160 MM GRASPER
FOR HAND



DAVIER VERBRUGGE 160 MM REDUCTEUR
POUR MAIN

D012358 VERBRUGGE BONE HOLDING
FORCEPS 160 MM REDUCTANT
FOR HAND



DAVIER

BONE HOLDING FORCEPS

DAVIER VERBRUGGE 150 MM PREHENSEUR
AUTO CENTREUR

D012365 VERBRUGGE BONE HOLDING FORCEPS
150 MM GRASPER SELF CENTERING



DAVIER VERBRUGGE 190 MM REDUCTEUR
AUTO CENTREUR

D012366 VERBRUGGE BONE HOLDING FORCEPS
190 MM REDUCTANT SELF CENTERING



D012367
240 MM

D012368
260 MM

D012369
280 MM



BREAKER

DECOLLEUR ABOULKER 5 x 200 MM

D022375 ABOULKER BREAKER
5 X 200 MM



D022376
3,5 X 200 MM

DECOLLEUR STENSTROM 160 MM LA PAIRE

D022379 STENSTROM BREAKER 160 MM THE PAIR



DECOLLEUR

BREAKER

DECOLLEUR SEGURA 4 x 145 MM
SPATULE TRANCHANT

D022378 *SEGURA BREAKER 4 X 145 MM
SHARP SPATULA*

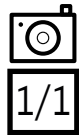

DECOLLEUR SEGURA 4 x 145 MM
SPATULE MOUSSE

D022377 *SEGURA BREAKER 4 X 145 MM
BLUNT SPATULA*



DERMATOME

DERMATOME LAGROS 90 MM
PAQUET DE 6 LAMES

D032381 LAGROS DERMATOME 90 MM
PACK OF 6 BLADES

DERMATOME LAGROS 90 MM INOX

D032384 LAGROS DERMATOME 90 MM
STAINLESS STEEL

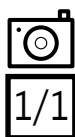

D032380
40 MM

D032382
140 MM



D032385
40 MM INOX
STAINLESS STEEL

D032383
140 MM INOX
STAINLESS STEEL



DILATATEUR NEURO 0,5 X 125 MM POUR VAISSEAUX

D052389 *NEURO DILATATOR 0,5 X 125 MM FOR VESSELS*

D052390
1 X 125 MM

D052391
1,5 X 125 MM



DILATATEUR RECTAL

RECTAL DILATATOR

www.in-surg.fr

D

DILATATEUR RECTAL BODENHAMMER 150 MM
D062393 *BODENHAMMER RECTAL DILATATOR 150 MM*



DILATATEUR RECTAL

RECTAL DILATATOR

DILATATEUR RECTAL BARR 22 X 70 MM

D062392 *BARR RECTAL DILATATOR 22 X 70 MM*

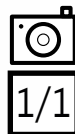
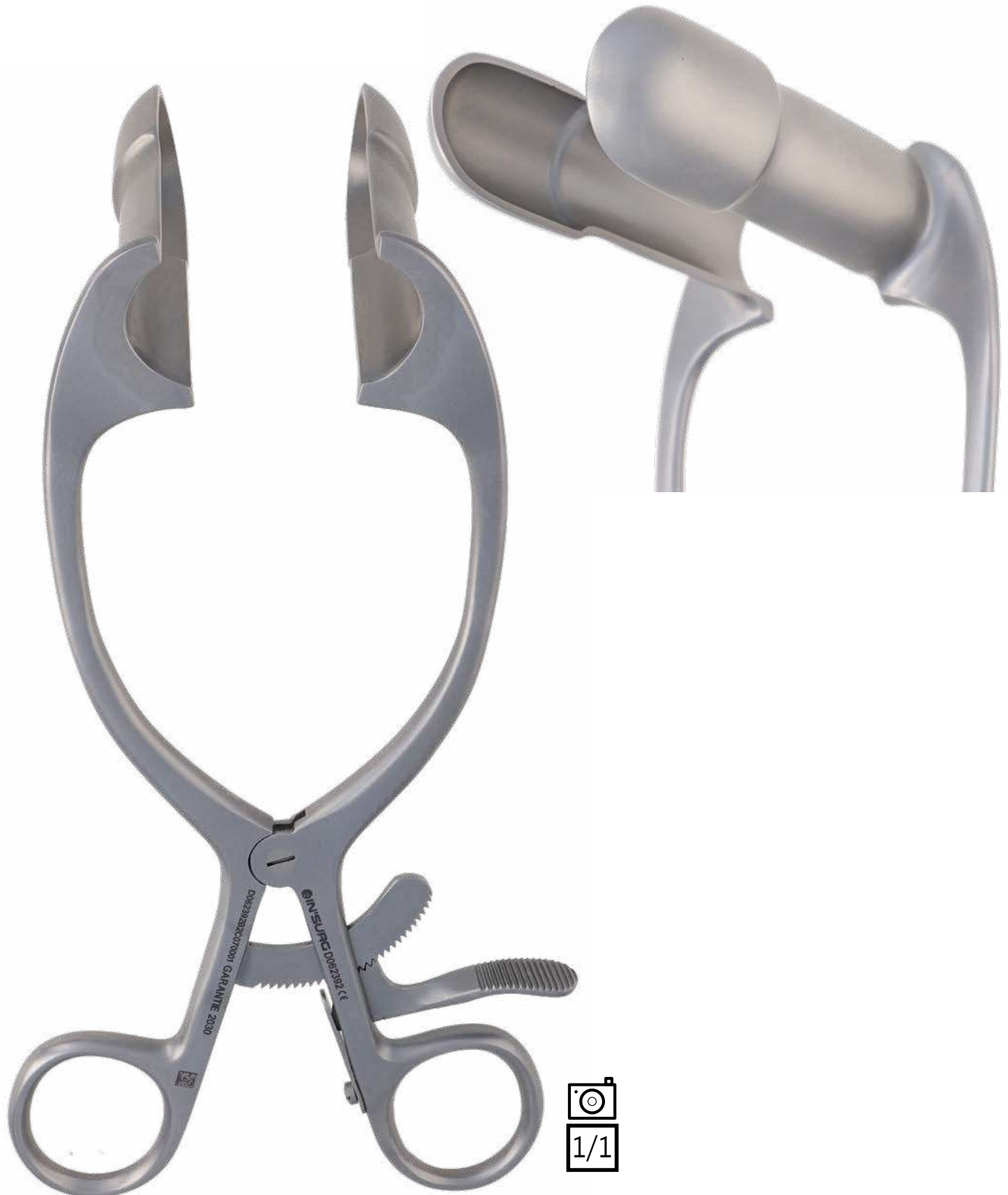

DILATATEUR RECTAL MATHIEU 195 MM

D062395 MATHIEU RECTAL DILATOR 195 MM

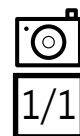

DILATATEUR RECTAL

RECTAL DILATATOR

DILATATEUR RECTAL PRATT 210 MM

D062396 PRATT RECTAL DILATATOR 210 MM

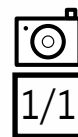

1/1

DILATATEUR RECTAL TRELAT 30 X 115 MM AVEC CREMAILLERE

D062397 TRELAT RECTAL DILATATOR 30 X 115 MM WITH RATCHET

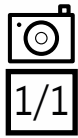

DILATATEUR RECTAL TRELAT 30 X 115 MM SANS CREMAILLERE
D062398 TRELAT RECTAL DILATATOR 30 X 115 MM WITHOUT RATCHET

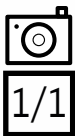

DILATATEUR TRACHEAL

www.in-surg.fr

D

TRACHEAL DILATOR

DILATATEUR TRACHEAL LABORDE 145 MM

D072399 LABORDE TRACHEAL DILATOR 145 MM



DILATATEUR TRACHEAL MARION-TRIEPIER 160 MM

D072400 MARION TRIPIER TRACHEAL DILATOR 160 MM



DILATATEUR TRACHEAL TROUSSEAU 140 MM
D072401 TROUSSEAU TRACHEAL DILATOR 140 MM



VASCULAR DILATOR

DILATATEUR VASCULAIRE DEBAKEY 4 X 190 MM

D092411 DEBAKEY VASCULAR DILATOR 4 X 190 MM

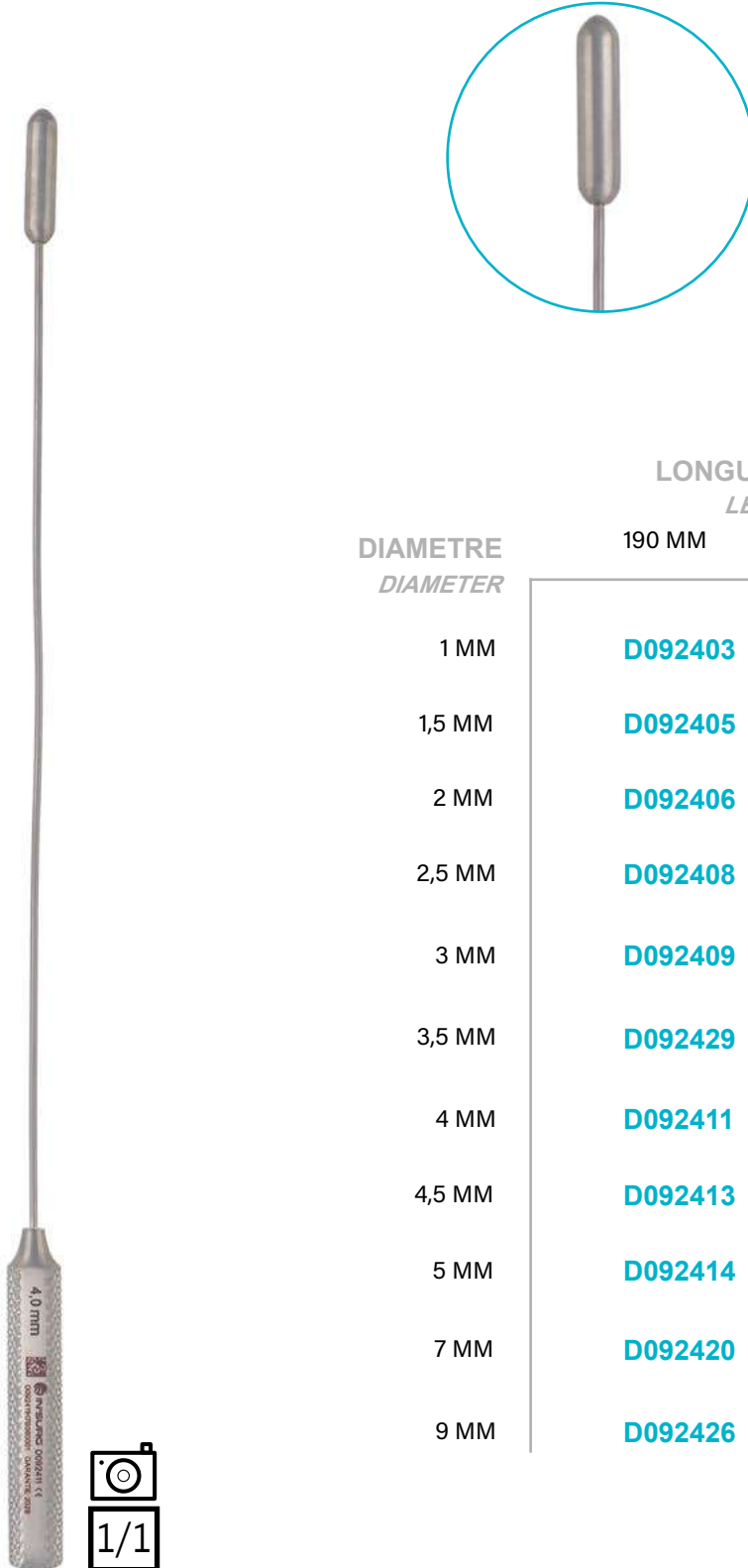

DIAMETRE DIAMETER	LONGUEUR LENGTH	
	190 MM	350 MM
1 MM	D092403	D092404
1,5 MM	D092405	
2 MM	D092406	D092407
2,5 MM	D092408	
3 MM	D092409	D092410
3,5 MM	D092429	
4 MM	D092411	D092412
4,5 MM	D092413	
5 MM	D092414	D092415
7 MM	D092420	D092421
9 MM	D092426	D092427

DILATATEUR VASCULAIRE GARRET 1 X 200 MM

D092438 GARRET VASCULAR DILATOR 1 X 200 MM

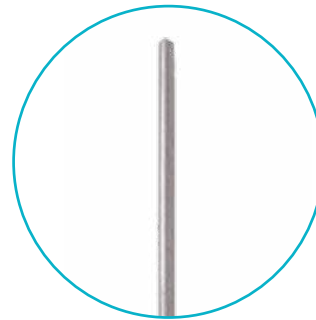

LONGUEUR
LENGTH
200 MM

DIAMETRE
DIAMETER

1 MM	D092438
1,5 MM	D092439
2 MM	D092440
2,5 MM	D092441
3 MM	D092442
3,5 MM	D092443
4 MM	D092444
4,5 MM	D092445
5 MM	D092446

GALL DUCT DILATATOR

DILATATEUR VOIES BILIAIRES BAKES 13 X 300 MM

D102459 BAKES GALL DUCT DILATOR 13 X 300 MM



DIAMETRE DIAMETER	LONGUEUR LENGTH 300 MM
1 MM	D102447
2 MM	D102448
3 MM	D102449
4 MM	D102450
5 MM	D102451
6 MM	D102452
7 MM	D102453
8 MM	D102454
9 MM	D102455
10 MM	D102456
11 MM	D102457
12 MM	D102458
13 MM	D102459

DISSECTEUR

DISSECTOR

DISSECTEUR CAIRNS 6 X 180 MM
POUR DURE MERE

D112460 CAIRNS DISSECTOR 6 X 180 MM
FOR DURA MATER

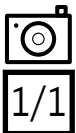

DISSECTEUR CARPENTIER 260 MM
POUR AMYGDALES

D112461 CARPENTIER DISSECTOR 260 MM
FOR TONSILS

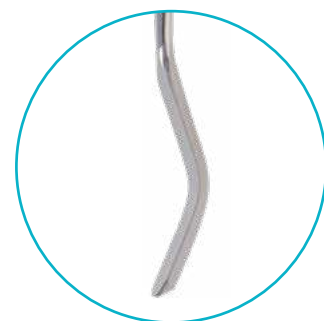
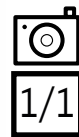

DISSECTEUR CASPAR 1 X 210 MM COUDE BAS
BAIONNETTE

D112462 CASPAR DISSECTOR 1 X 210 MM ANGLED
DOWN BAYONET



D112462
1 X 210 MM - COUDE BAS
ANGLED DOWN
D112466
4.5 X 230 MM - COUDE BAS
ANGLED DOWN

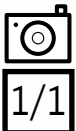

DISSECTEUR CASPAR 1 X 210 MM COUDE HAUT
BAIONNETTE

D112463 CASPAR DISSECTOR 1 X 210 MM ANGLED UP
BAYONET



DISSECTEUR

DISSECTOR

DISSECTEUR CASPAR 4.5 X 230 MM COURBE
BAIONNETTE

D112465 CASPAR DISSECTOR 4.5 X 230 MM CURVED
BAYONET



D112464
2 X 230 MM

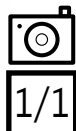

DISSECTEUR CASPAR 1 X 200 MM
COURBE

D112467 CASPAR DISSECTOR 1 X 200 MM
CURVED

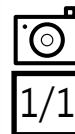

DISSECTEUR CLOVIS VINCENT 7 X 200 MM
DURE MERE

D112468 CLOVIS VINCENT DISSECTOR 7 X 200 MM
FOR DURA MATER



DISSECTEUR COTTLE 210 MM CLOISON
MOUSSE TRANCHANT

D112469 COTTLE DISSECTOR 210 MM DOUBLE
BLUNT - SHARP FOR SEPTUM



DISSECTEUR

DISSECTOR

DISSECTEUR CREED 210 MM
1 COTE TRANCHANT 3,8 MM
1 COTE MOUSSE 3,5 MM

D112470 CREED DISSECTOR 210 MM DOUBLE
1 SHARP EDGE 3,8 MM
1 BLUNT EDGE 3,5 MM

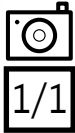
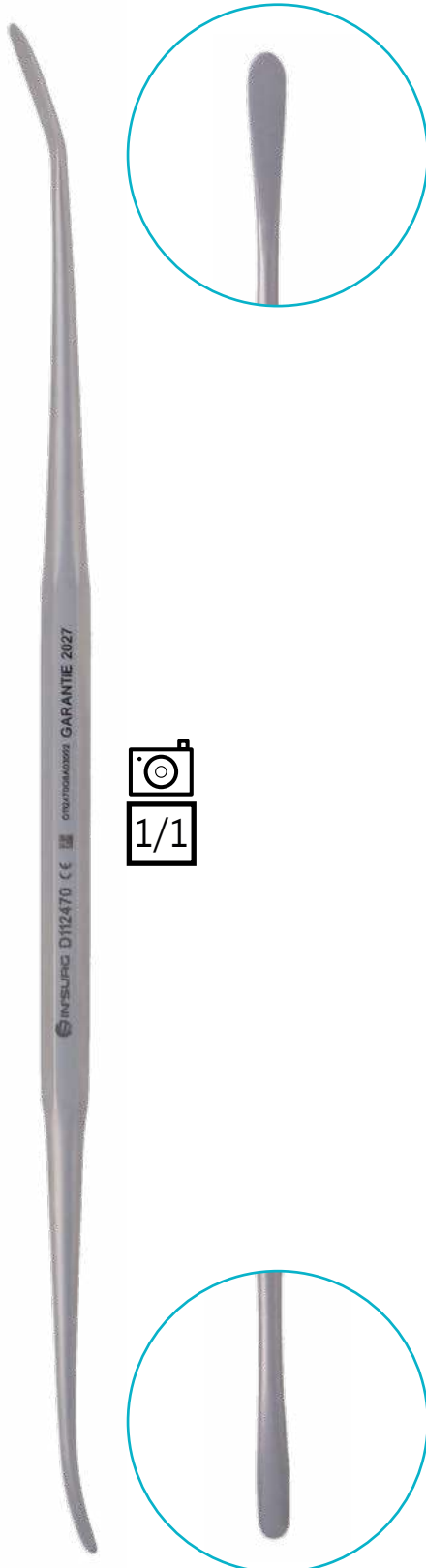

DISSECTEUR DAVID - SACHS 6 X 210 MM
D112471 DAVID - SACHS DISSECTOR 6 X 210 MM

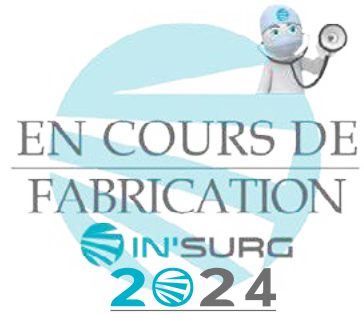

DISSECTEUR FRAZIER 150 MM POUR DURE MERE
D112473 FRAZIER DISSECTOR 150 MM FOR DURA MATER



DISSECTEUR DAVIS 245 MM
1 COTE TRANCHANT 6 MM
1 COTE MOUSSE 6,8 MM

D112472 DAVIS DISSECTOR 245 MM
1 SHARP EDGE 6 MM
1 BLUNT EDGE 6,8 MM



DISSECTEUR

DISSECTOR

DISSECTEUR FREER 200 MM
1 COTE TRANCHANT 4,5 MM
1 COTE MOUSSE 5 MM

D112474 *FREER DISSECTOR 200 MM*
1 SHARP EDGE 4,5 MM
1 BLUNT EDGE 5 MM

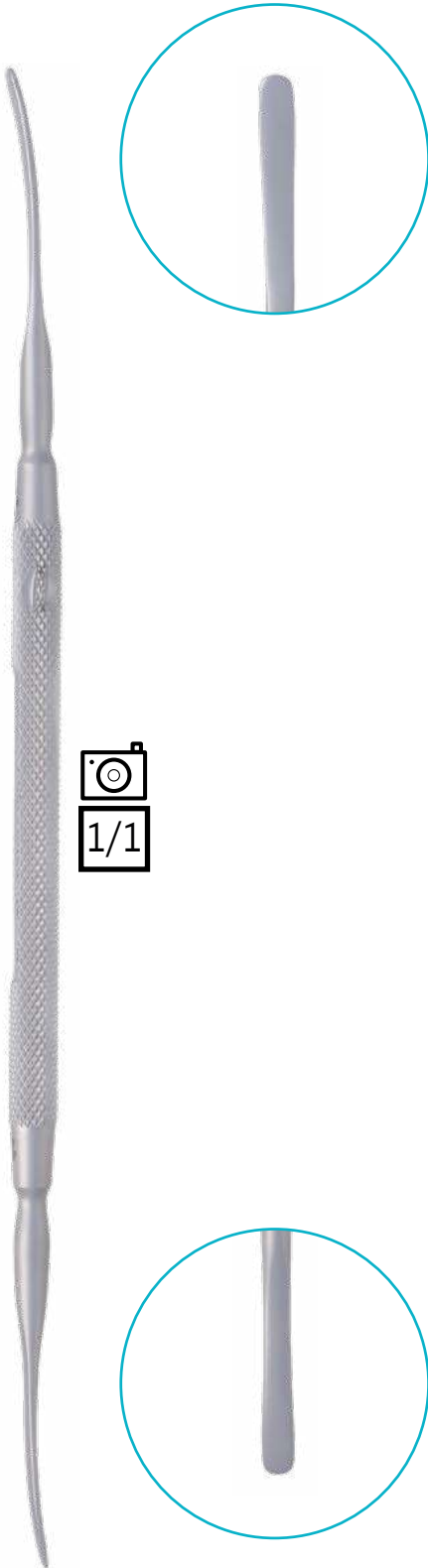

DISSECTEUR GUILLEN ASPIRATEUR
D112475 *GUILLEN DISSECTOR SUCTION*



DISSECTEUR HENKE 4 X 11 X 230 MM
D112476 HENKE DISSECTOR 4 X 11 X 230 MM

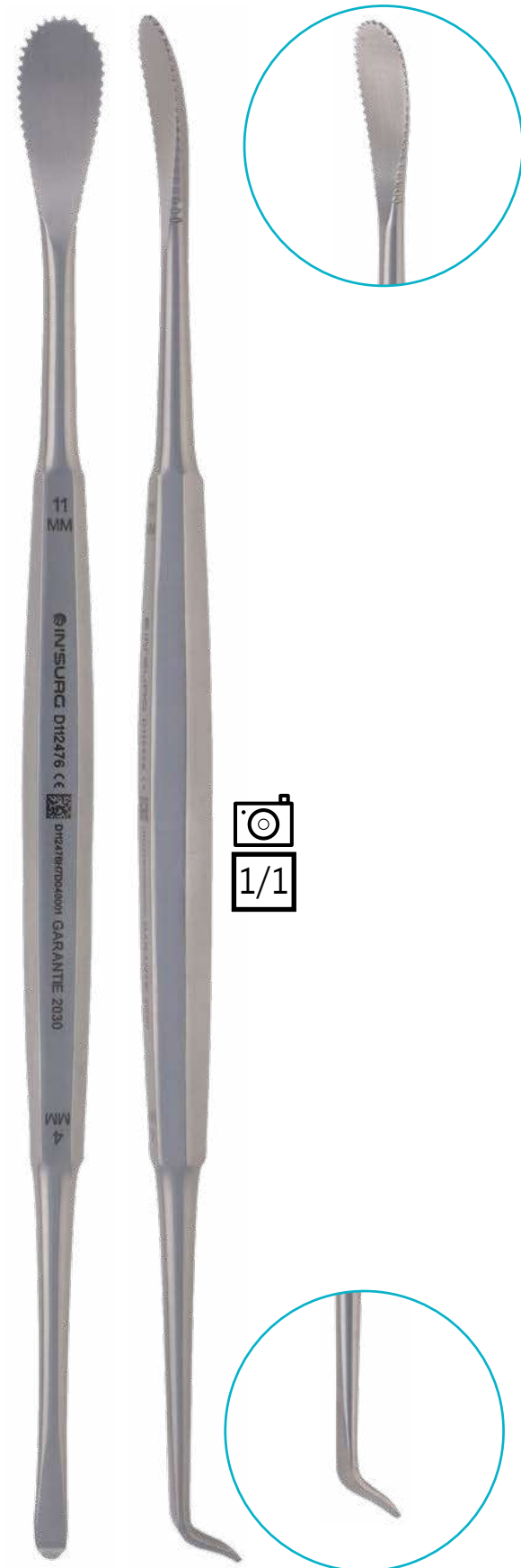

DISSECTEUR HOEN 150 MM COUDE A 45°
D112477 HOEN DISSECTOR 150 MM ANGLED 45°



D112477
150 MM
COUDE A 45°
ANGLED 45°

D112478
150 MM
COUDE A 90°
ANGLED 90°

DISSECTEUR

DISSECTOR

DISSECTEUR HOSOBUCHI 260 MM
 SPATULE NEURO
D112479 HOSOBUCHI NEURO
 DISSECTOR 260 MM SPATULA



DISSECTEUR HURD 225 MM AMYGDALES
D112480 HURD DISSECTOR 225 MM TONSILS

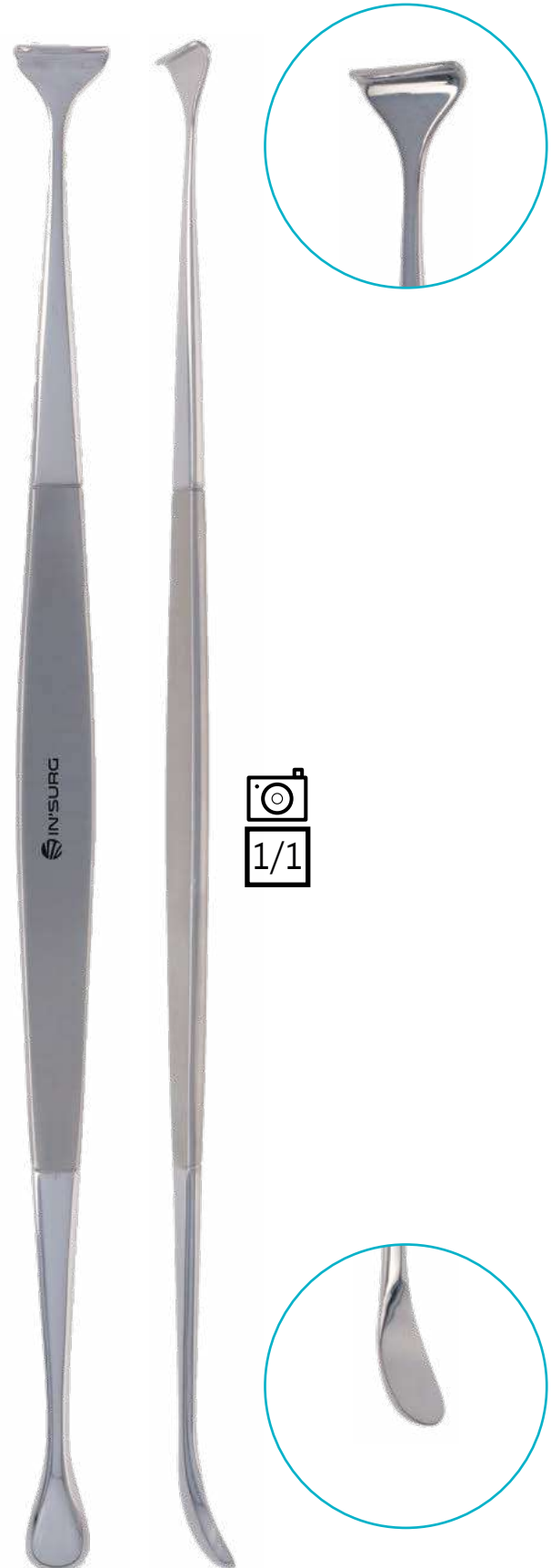

DISSECTEUR KILLIAN 190 MM
MOUSSE TRANCHANT

D112481 *KILLIAN DISSECTOR 190 MM
BLUNT - SHARP*

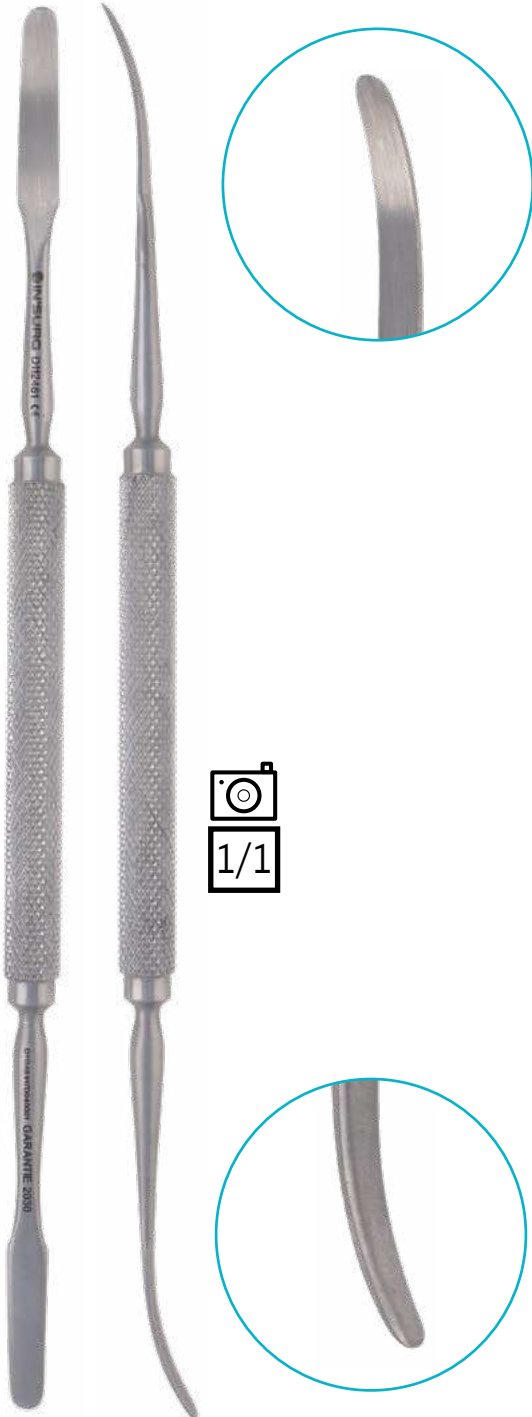

DISSECTEUR KILLIAN 220 MM
MOUSSE TRANCHANT

D112482 *KILLIAN DISSECTOR 220 MM
BLUNT - SHARP*

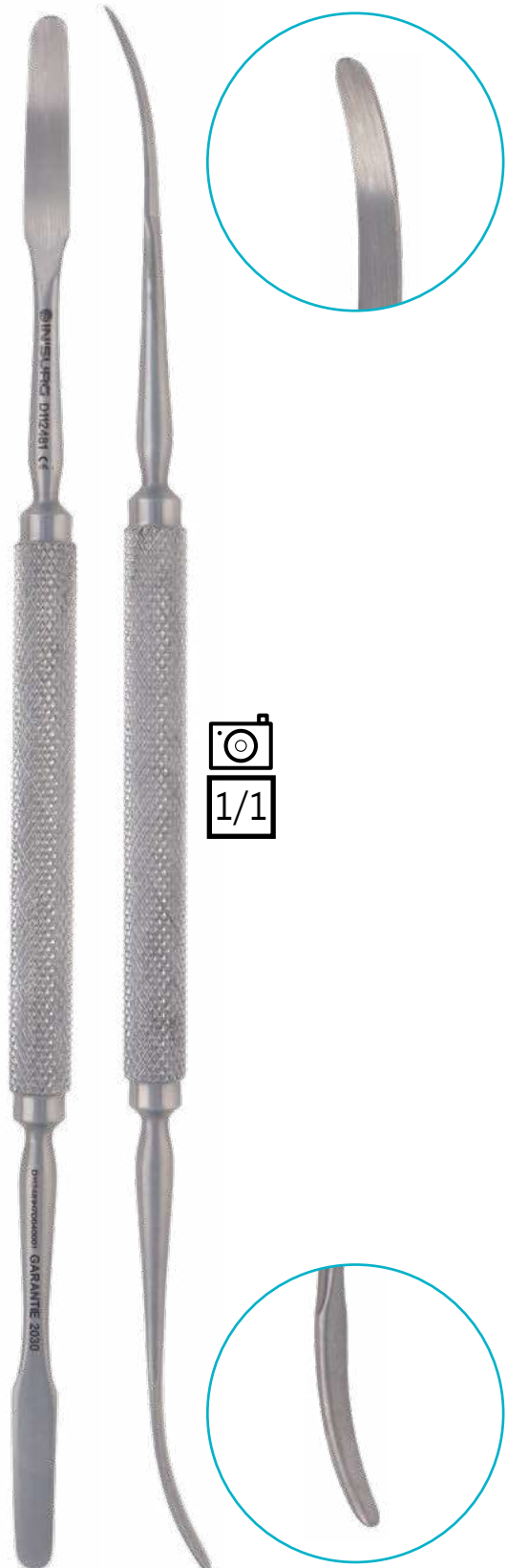

DISSECTEUR

DISSECTOR

DISSECTEUR LERICHE 3,5 X 170 MM

D112489 LERICHE DISSECTOR 3,5 X 170 MM

DISSECTEUR PENFIELD 3 X 205 MM
MOUSSE SIMPLE

D112495 PENFIELD DISSECTOR 3 X 205 MM
BLUNT SIMPLE



DISSECTEUR PENFIELD 175 MM
COTE CURETTE TRANCHANTE 7 MM
COTE DISSECTEUR MOUSSE 7 MM

D112496 PENFIELD DISSECTOR 175 MM
1 CURETTE EDGE SHARP 7 MM,
1 DISSECTOR EDGE BLUNT 7 MM

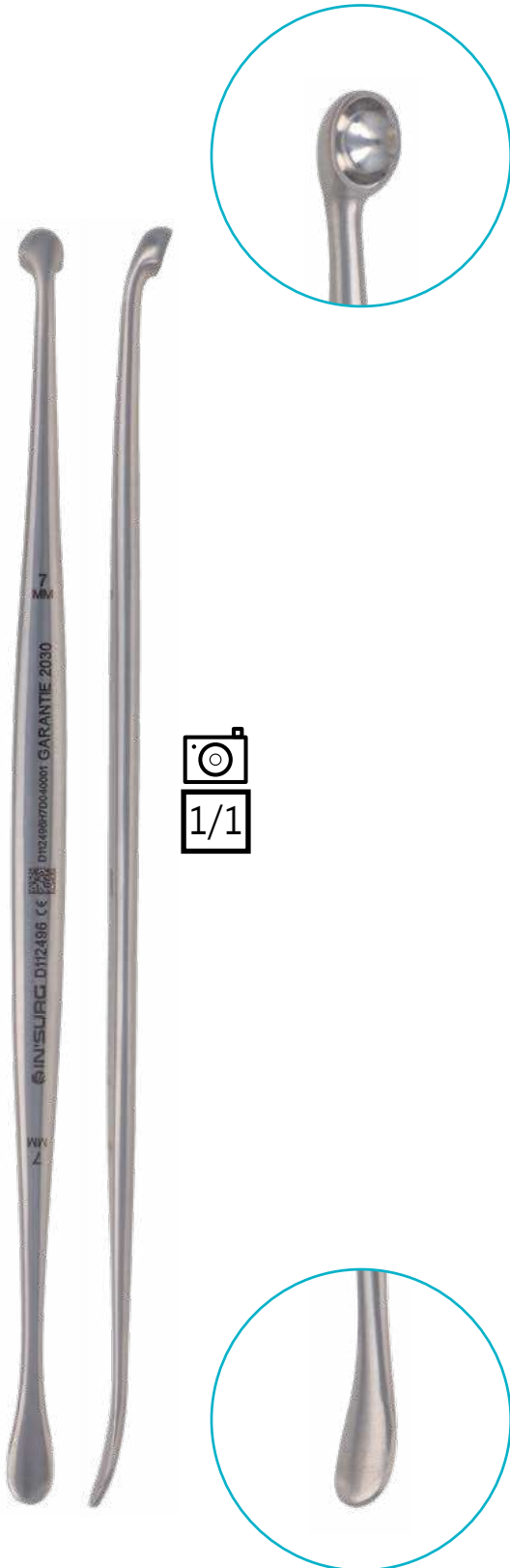

DISSECTEUR PENFIELD 195 MM
COTE REPOUSSOIR 4 X 2,5 MM,
COTE DISSECTEUR SEMI COURBE MOUSSE 7 MM

D112497 PENFIELD DISSECTOR 195 MM
1 REPOUSSOIR EDGE 4 X 2,5 MM,
1 DISSECTOR EDGE SEMI CURVED BLUNT 7 MM

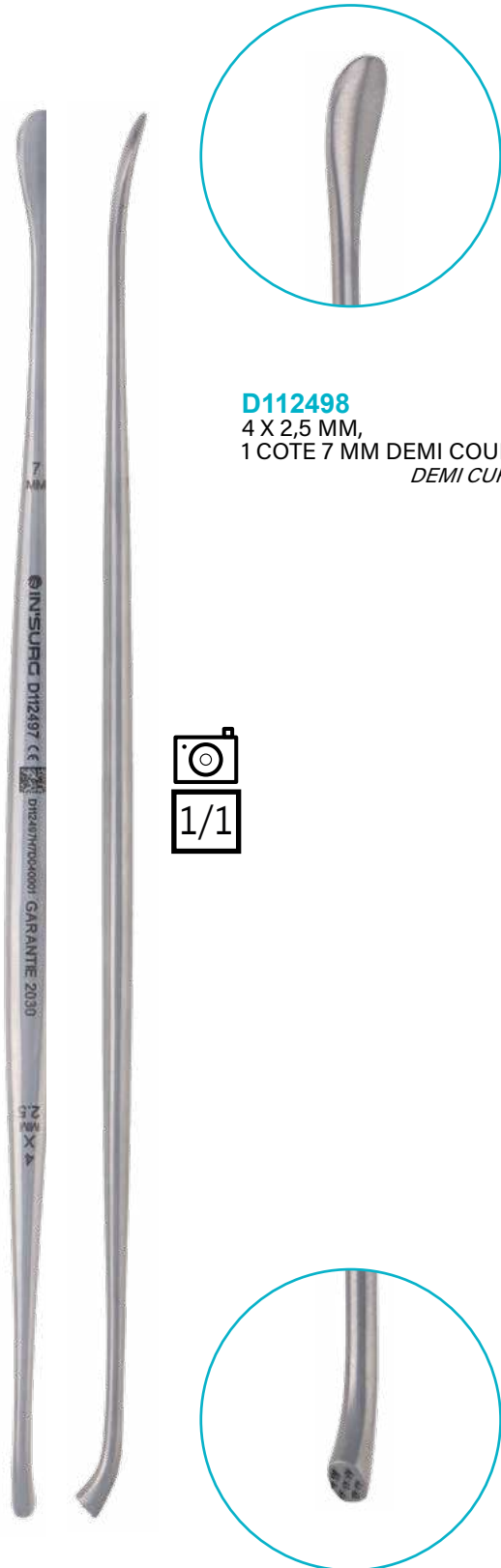

D112498
4 X 2,5 MM,
1 COTE 7 MM DEMI COURBE
DEMI CURVED

DISSECTEUR

DISSECTOR

DISSECTEUR RIZZUTI 200 MM
D112499 RIZZUTI DISSECTOR 200 MM

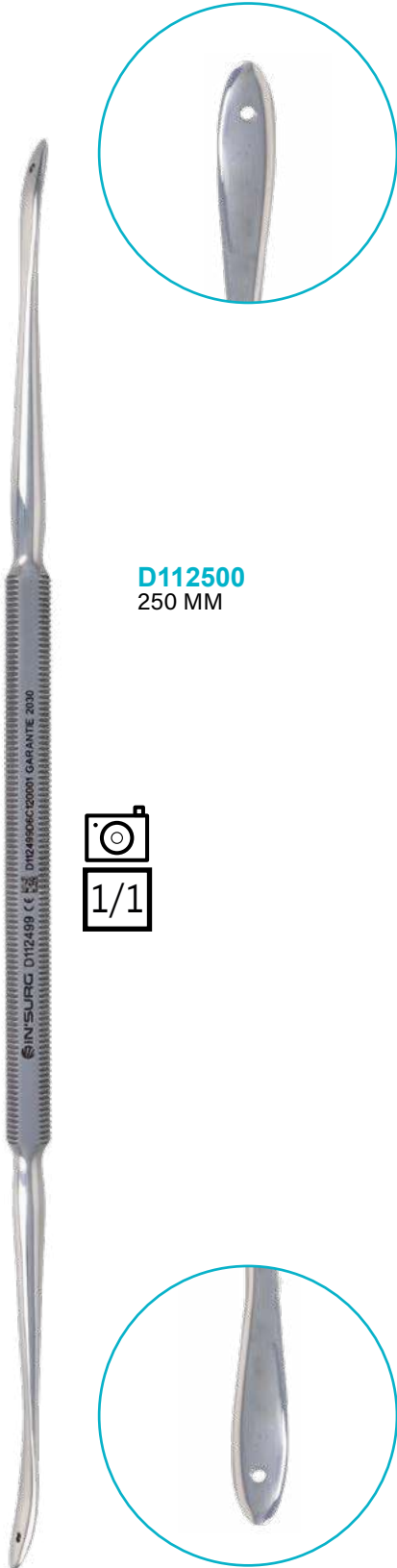

D112500
 250 MM

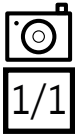

DISSECTEUR ROBB 2,2 - 3,0 MM X 210 MM
 MOUSSE DOUBLE

D112501 ROBB DISSECTOR 2,2 - 3,0 MM X 210 MM
 BLUNT DOUBLE

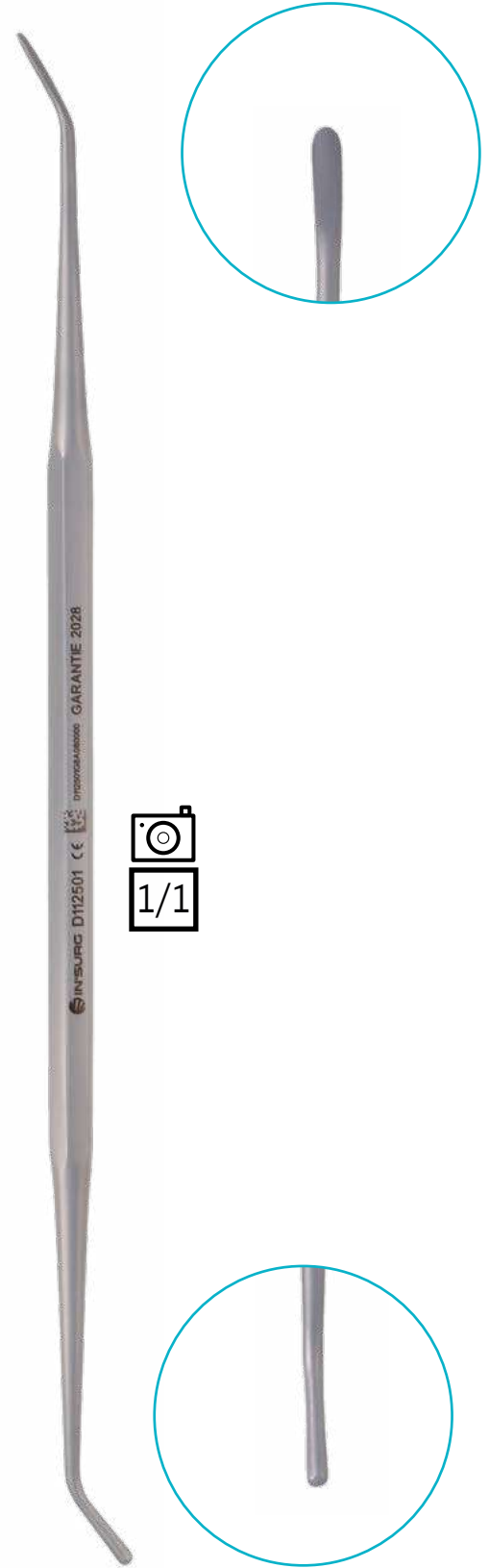

DISSECTEUR SACHS 3 X 210 MM
TRANCHANT

D112502 SACHS DISSECTOR 3 X 210 MM
SHARP



DISSECTEUR TONNIS 3 - 5 MM X 240 MM DOUBLE
D112505 TONNIS DISSECTOR 3 - 5 MM X 240 MM DOUBLE



D112506
5 - 5 MM X 240 MM

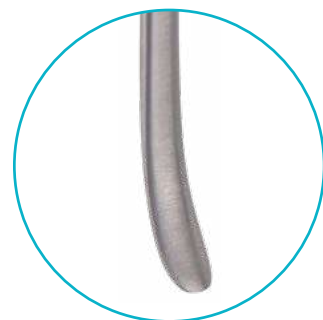

DISSECTEUR

DISSECTOR

DISSECTEUR SCOVILLE 300 MM
CROCHET ANGLE

D112503 *SCOVILLE DISSECTOR 300 MM
ANGLED HOOK*

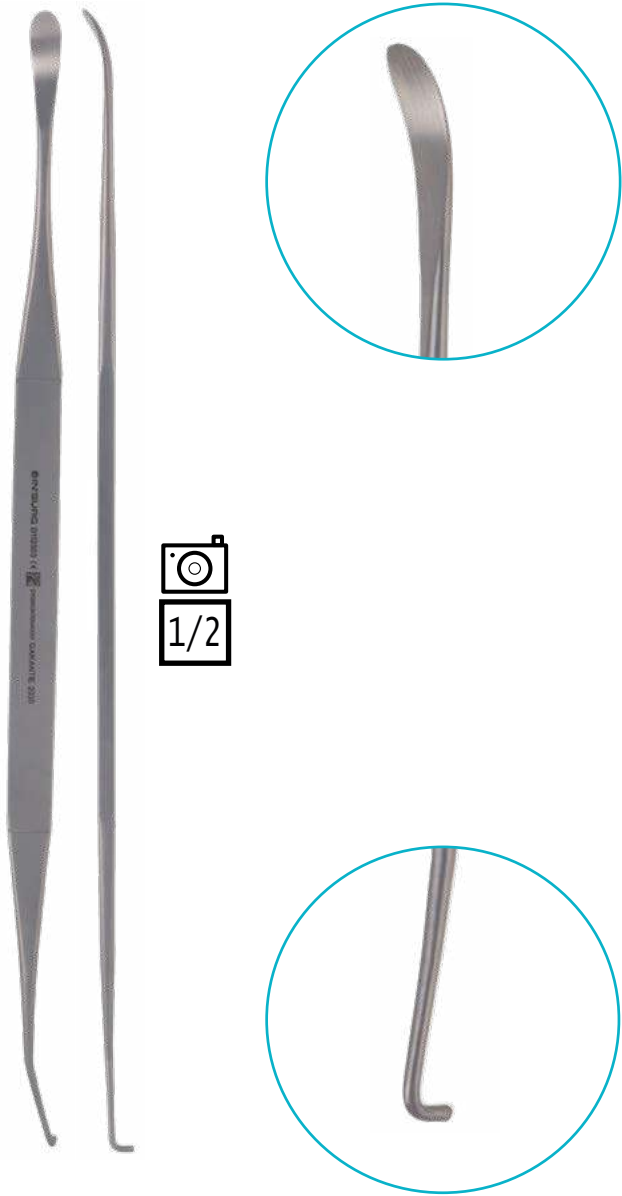

DISSECTEUR SCOVILLE 300 MM
CROCHET COURBE

D112504 *SCOVILLE DISSECTOR 300 MM
HOOK CURVED*

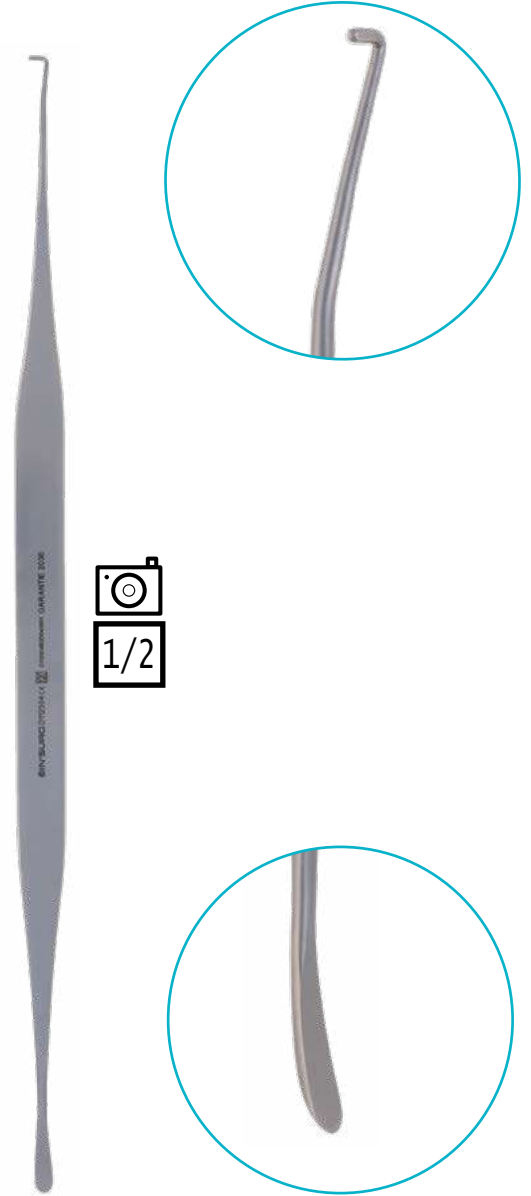

DISSECTEUR WATSON CHEYNE 125 MM DOUBLE

D112507 *WATSON CHEYNE DISSECTOR 125 MM DOUBLE*



DISSECTEUR YASARGIL 1 X 185 MM ANGLE

D112509 YASARGIL DISSECTOR 1 X 185 MM
ANGLED



DISSECTEUR YASARGIL 4 X 185 MM ANGLE ROND

D112511 YASARGIL DISSECTOR 4 X 185 MM
ANGLED ROUND



SOMMAIRE

ECARTEUR :	
(SUR MANCHE).....	489
<i>HANDLE RETRACTOR</i>	
ABDOMINAL.....	555
<i>ABDOMINAL RETRACTOR</i>	
AUTOSTATIQUE.....	578
<i>AUTOSTATIC RETRACTOR</i>	
AUTOSTATIQUE CASPAR.....	627
<i>CASPAR AUTOSTATIC RETRACTOR</i>	
AUTOSTATIQUE CLOWARD.....	639
<i>CLOWARD AUTOSTATIC RETRACTOR</i>	
AUTOSTATIQUE SCOVILLE HAVERFIELD.....	645
<i>SCOVILLE HAVERFIELD AUTOSTATIC RETRACTOR</i>	
DOUBLE.....	647
<i>DOUBLE RETRACTOR</i>	
THORACIQUE.....	659
<i>THORACIC RETRACTOR</i>	
ECRASEUR/ETAU.....	666
<i>INTESTINAL AND PYLORUS CLAMPS</i>	
ELEVATEUR.....	668
<i>ELEVATOR</i>	
ETRIER.....	674
<i>TRACTIONS BOWS</i>	
EXTRACTEUR.....	677
<i>EXTRACTOR</i>	



E

RETRO 'SPECTIVE

Willem EINTHOVEN (21 mai 1860 - 29 septembre 1927)

était un **physiologiste** néerlandais renommé ayant reçu **le prix Nobel de médecine** en 1924, pour avoir inventé **le premier électrocardiogramme**. Il donna alors naissance à la **cardiologie moderne**.
Il a également publié un article et mené de nombreuses études sur les diverses illusions géométriques-optiques.

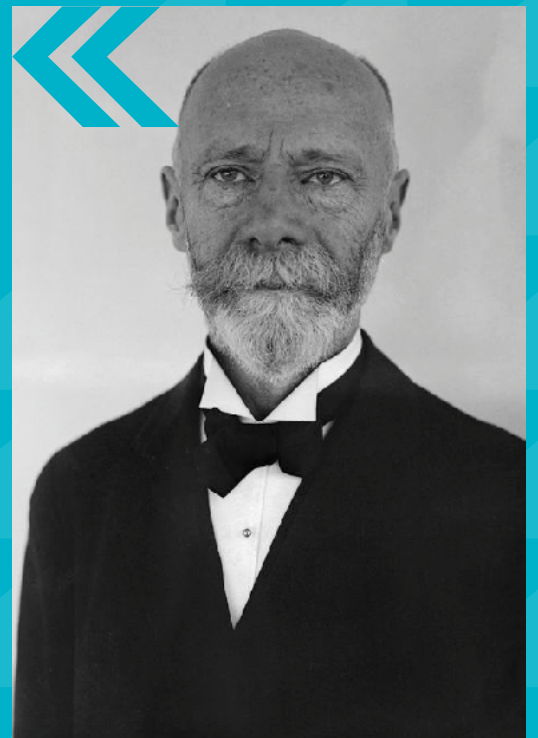

ECARTEUR SUR MANCHE

HANDLE RETRACTOR



ECARTEUR SUR MANCHE AUFRICT 45 X 160 MM
E012515 AUFRICT HANDLE RETRACTOR 45 X 160 MM



ECARTEUR SUR MANCHE BANKART 20 MM POUR RECLINER LES MUSCLES

E012517 BANKART HANDLE RETRACTOR 20 MM FOR RECLINING THE MUSCLES

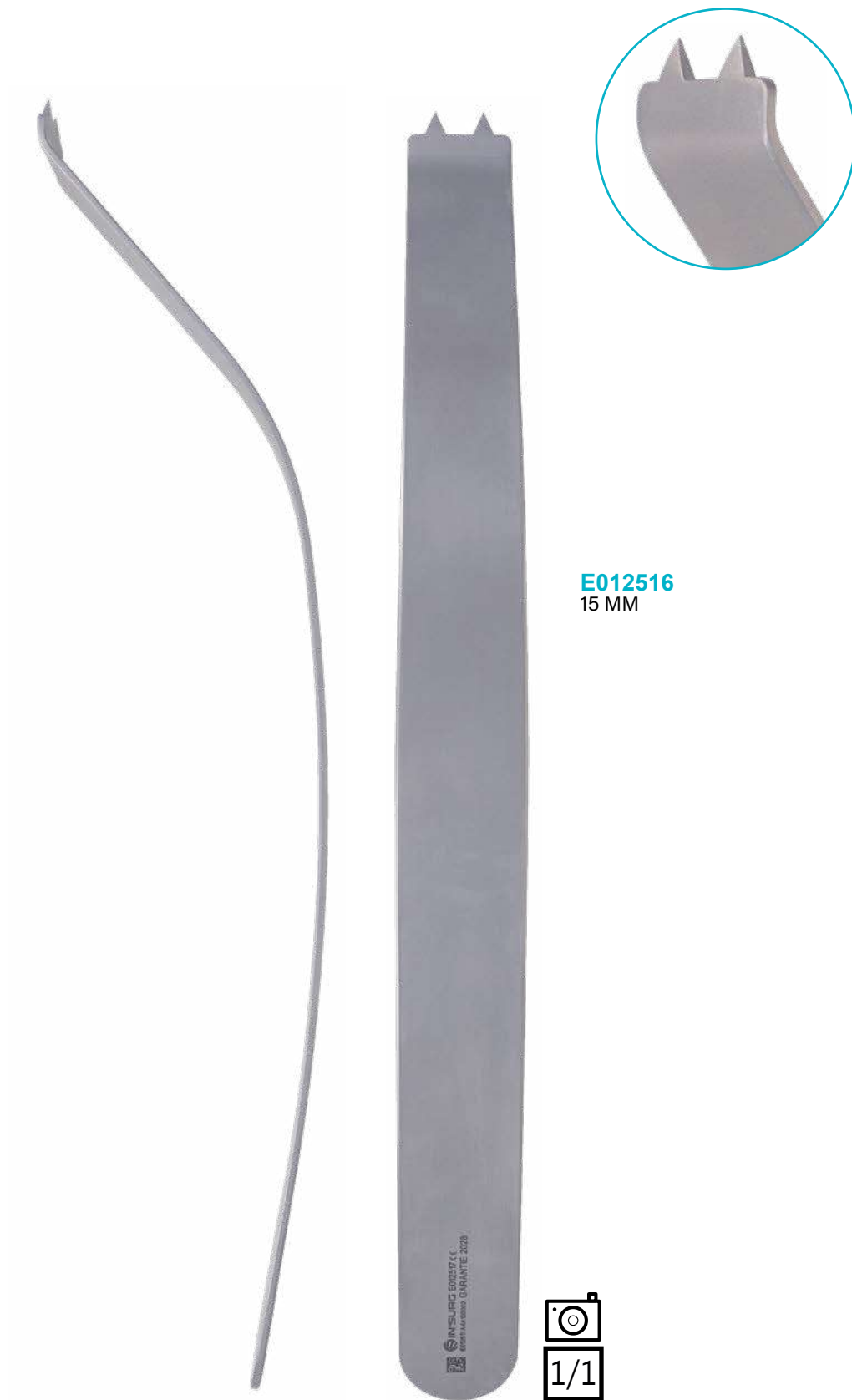

E012516
15 MM

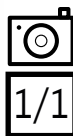

ECARTEUR SUR MANCHE BANKART POUR TETE HUMERALE
E012518 BANKART HANDLE RETRACTOR FOR THE HUMERAL HEAD



ECARTEUR SUR MANCHE BENNET 50 X 260 MM
E012520 *BENNET HANDLE RETRACTOR 50 X 260 MM*



E012521
60 X 260 MM

E012522
65 X 260 MM

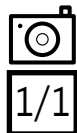

ECARTEUR SUR MANCHE BLOUNT
5 X 40 X 170 MM
E012523 *BLOUNT HANDLE RETRACTOR
5 X 40 X 170 MM*

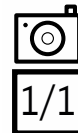

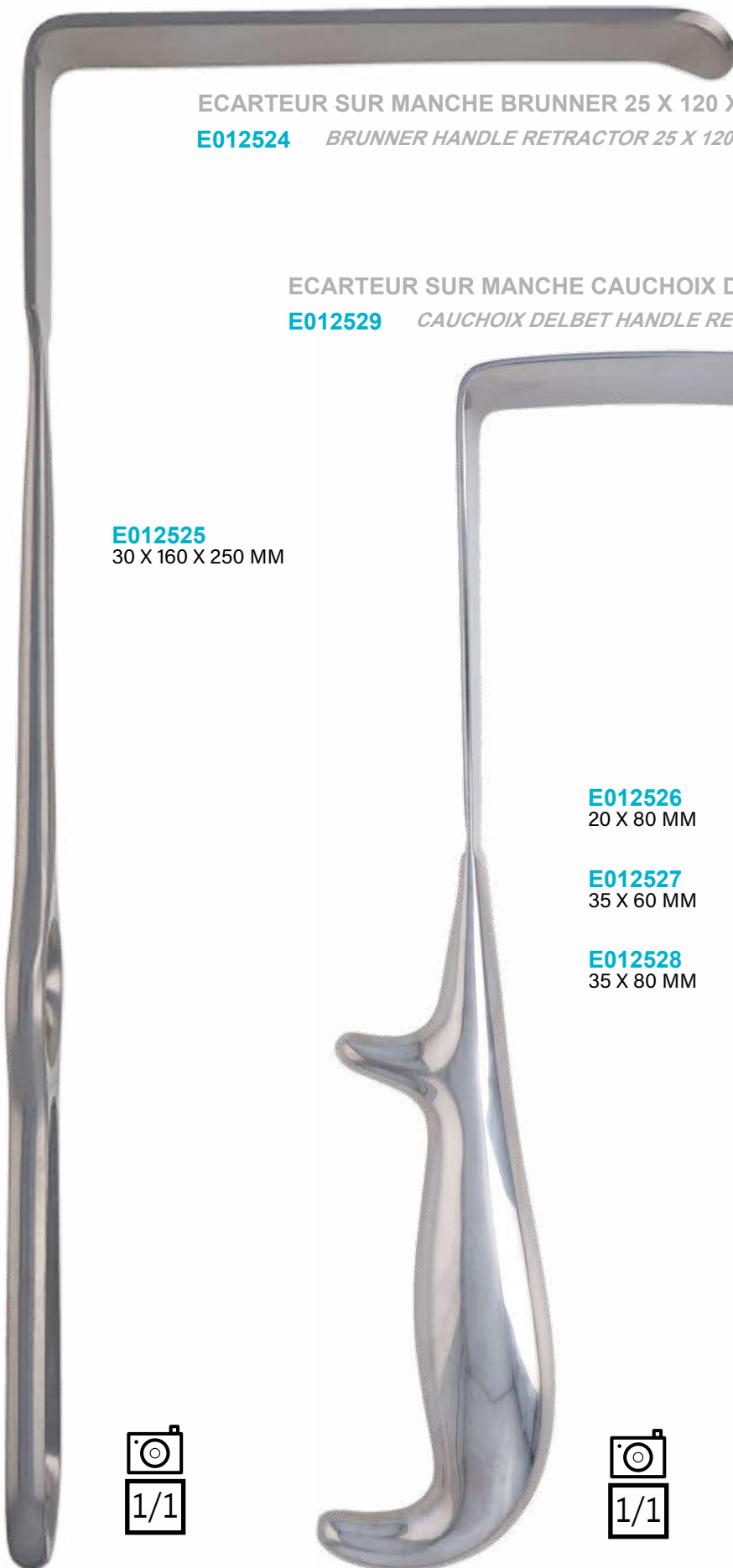

ECARTEUR SUR MANCHE BRUNNER 25 X 120 X 250 MM

E012524 BRUNNER HANDLE RETRACTOR 25 X 120 X 250 MM

ECARTEUR SUR MANCHE CAUCHOIX DELBET 40 X 100 MM

E012529 CAUCHOIX DELBET HANDLE RETRACTOR 40 X 100 MM

E012525
30 X 160 X 250 MM

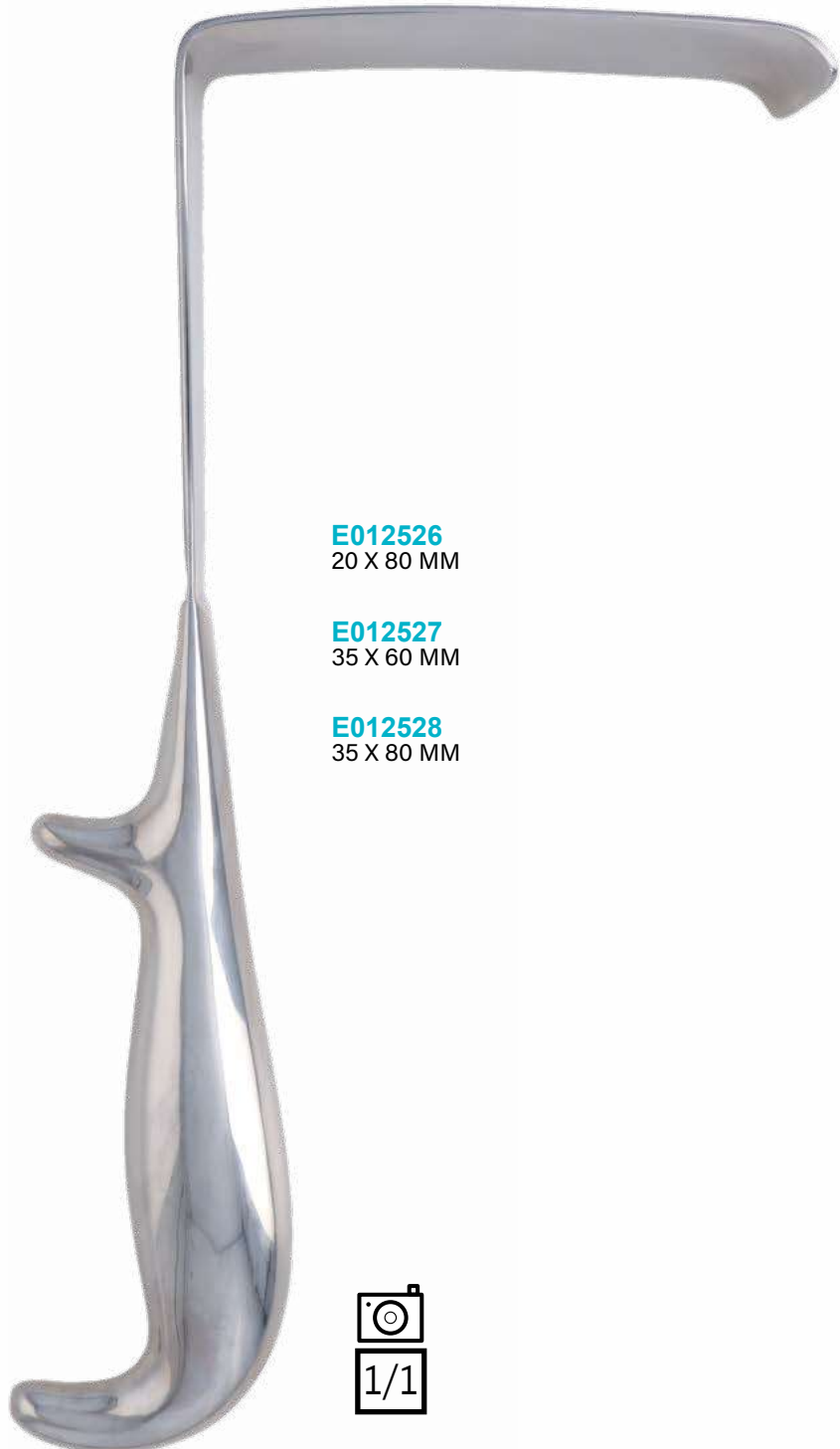

E012526
20 X 80 MM

E012527
35 X 60 MM

E012528
35 X 80 MM

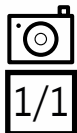

ECARTEUR SUR MANCHE CHIGOT 6 X 21 X 170 MM
E012530 CHIGOT HANDLE RETRACTOR 6 X 21 X 170 MM



E012531
6 X 15 X 170 MM

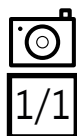

ECARTEUR SUR MANCHE

HANDLE RETRACTOR

ECARTEUR SUR MANCHE CLOWARD
11 X 38 X 197 MM

E012532 CLOWARD HANDLE RETRACTOR
11 X 38 X 197 MM

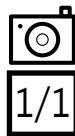

ECARTEUR SUR MANCHE CLOWARD 18 X 76 X 180 MM

E012534 CLOWARD HANDLE RETRACTOR 18 X 76 X 180 MM

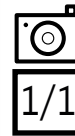

E012535
20 X 76 X 180 MM

E012536
23 X 76 X 180 MM

ECARTEUR SUR MANCHE COOLEY 48 X 48 X 250 MM CANNELE
E012537 *COOLEY HANDLE RETRACTOR 48 X 48 X 250 MM CANNELE*

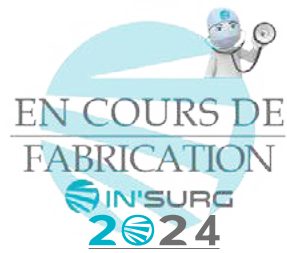

ECARTEUR SUR MANCHE

HANDLE RETRACTOR

ECARTEUR SUR MANCHE COOLEY
48 X 32 X 250 MM MITRAL A GAUCHE

E012538 *COOLEY HANDLE RETRACTOR
48 X 32 X 250 MM AT LEFT MITRAL*

ECARTEUR SUR MANCHE COOLEY
48 X 48 X 250 MM MITRAL A DROITE

E012539 *COOLEY HANDLE RETRACTOR
48 X 48 X 250 MM AT RIGHT MITRAL*

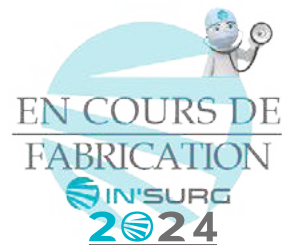
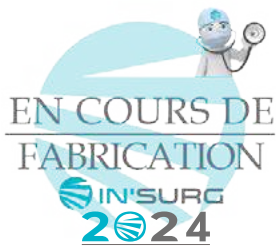

ECARTEUR SUR MANCHE CORYLLOS 38 X 115 X 225 MM

E012541 CORYLLOS HANDLE RETRACTOR 38 X 115 X 225 MM



E012540
22 X 82 X 240 MM

E012541
38 X 115 X 225 MM

E012542
65 X 115 X 240 MM

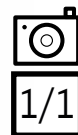
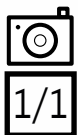

ECARTEUR SUR MANCHE

HANDLE RETRACTOR

ECARTEUR SUR MANCHE COTTLE
140 MM POINTE A DROITE

E012543 COTTLE HANDLE RETRACTOR 140 MM
POINTS TO THE RIGHT

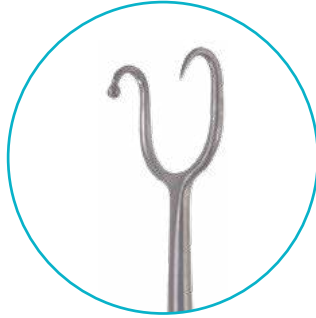

ECARTEUR SUR MANCHE CRAWFORD
22 X 20 X 190 MM AORTIQUE

E012544 CRAWFORD HANDLE RETRACTOR
20 X 22 X 190 MM AORTIC

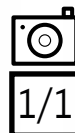

ECARTEUR SUR MANCHE CUSHING 6 X 240 MM
E012545 CUSHING HANDLE RETRACTOR 6 X 240 MM



ECARTEUR SUR MANCHE CUSHING
10 X 18 X 200 MM COUDE
E012558 CUSHING HANDLE RETRACTOR
 10 X 18 X 200 MM ANGLED



LARGEUR WIDTH	LONGUEUR LENGTH	
	200 MM	240 MM
6 MM		E012545
8 MM	E012546	E012547
10 MM	E012548	E012549
12 MM	E012550	E012551
14 MM	E012552	E012553
16 MM	E012554	E012555
18 MM	E012556	E012557

6 mm
 IN'SURG E012545 CE
 GARANTIE 2028

IN'SURG E012558 CE
 GARANTIE 2028

10 X 18 MM

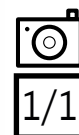

HANDLE RETRACTOR

ECARTEUR SUR MANCHE CUSHING
14 X 11 X 250 MM

E012559 CUSHING HANDLE RETRACTOR
14 X 11 X 250 MM



E012559
14 X 11 X 250 MM



E012560
18 X 13 X 250 MM



E012561
22 X 15 X 250 MM

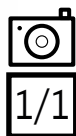

ECARTEUR SUR MANCHE DANIS
25 X 300 MM

E012562 DANIS HANDLE RETRACTOR
25 X 300 MM



E012563
40 X 300 MM

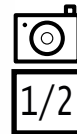

ECARTEUR SUR MANCHE DAVIDSON 90 X 75 MM POUR POUMONS
E012567 DAVIDSON HANDLE RETRACTOR 90 X 75 MM FOR LUNGS



E012565
50 X 75 MM

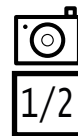

ECARTEUR SUR MANCHE DESMARRES 8 X 160 MM

E012568 DESMARRES HANDLE RETRACTOR 8 X 160 MM

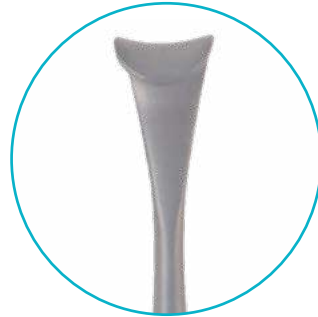
E012568
8 X 160 MME012569
10 X 160 MME012570
12 X 160 MME012571
14 X 160 MME012572
16 X 160 MME012573
18 X 160 MM

ECARTEUR SUR MANCHE FARABEUF MINI
5 X 17 X 160 MM POUR LA MAIN

E012574 FARABEUF HANDLE RETRACTOR
MINI 5 X 17 X 160 MM FOR THE HAND

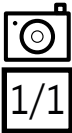

E012575
6 X 10 MM



E012576
6 X 20 MM



E012577
8 X 22 MM

ECARTEUR SUR MANCHE FARABEUF TRILLAT
10 X 40 X 220 MM

E012705 FARABEUF TRILLAT HANDLE RETRACTOR
10 X 40 X 220 MM

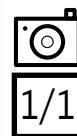

E012704
10 X 30 MM

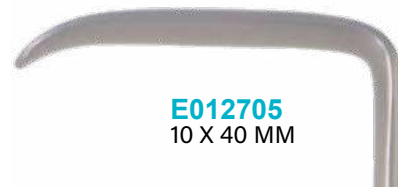

E012705
10 X 40 MM



E012706
10 X 50 MM



E012707
13 X 43 MM



E012708
14 X 30 MM



E012709
14 X 33 MM



E012710
16 X 30 MM

ECARTEUR SUR MANCHE FOMON 160 MM
BOUTONNE

E012578 FOMON HANDLE RETRACTOR 160 MM
BUTTONNE

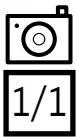

ECARTEUR SUR MANCHE FRITSCH
37 X 31 X 235 MM

E012579 FRITSCH HANDLE RETRACTOR
37 X 31 X 235 MM

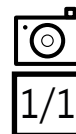

ECARTEUR SUR MANCHE FUKUDA 225 MM

E012580 *FUKUDA HANDLE RETRACTOR 225 MM*



ECARTEUR SUR MANCHE GILVERNET
9 X 280 MM MALLEABLE

E012581 GILVERNET HANDLE RETRACTOR
9 X 280 MM MALLEABLE

ECARTEUR SUR MANCHE GILVERNET
9 X 240 MM RIGIDE

E012586 GILVERNET HANDLE RETRACTOR
9 X 240 MM RIGID



E012581
9 X 280 MM



E012582
11 X 280 MM

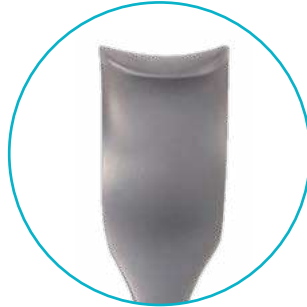

E012583
13 X 280 MM



E012584
15 X 280 MM



E012585
18 X 280 MM

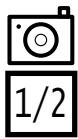
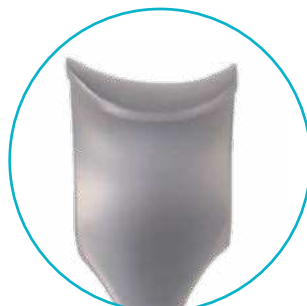

E012586
9 X 240 MM

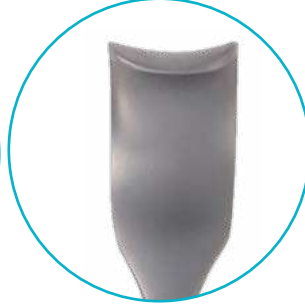

E012587
11 X 240 MM



E012588
13 X 240 MM



E012589
15 X 240 MM



E012590
18 X 240 MM



**ECARTEUR SUR MANCHE GUILLAUME
5 X 150 MM**

E012591 *GUILLAUME HANDLE RETRACTOR
5 X 150 MM*



**ECARTEUR SUR MANCHE HOHMANN
15 X 150 MM A ANNEAU**

E012592 *HOHMANN HANDLE RETRACTOR
15 X 150 MM TO RING*



ECARTEUR SUR MANCHE

HANDLE RETRACTOR

ECARTEUR SUR MANCHE HOHMANN
2,8 X 150 MM

E012593 HOHMANN HANDLE RETRACTOR
2,8 X 150 MM



ECARTEUR SUR MANCHE HOHMANN
7 X 150 MM

E012595 HOHMANN HANDLE RETRACTOR
7 X 150 MM



ECARTEUR SUR MANCHE HOHMANN
5 X 150 MM

E012594 HOHMANN HANDLE RETRACTOR
5 X 150 MM



ECARTEUR SUR MANCHE HOHMANN
6 X 160 MM

E012596 HOHMANN HANDLE RETRACTOR
6 X 160 MM



ECARTEUR SUR MANCHE HOHMANN
7,5 X 160 MM

E012597 HOHMANN HANDLE RETRACTOR
7,5 X 160 MM



ECARTEUR SUR MANCHE HOHMANN
8 X 160 MM

E012598 HOHMANN HANDLE RETRACTOR
8 X 160 MM



ECARTEUR SUR MANCHE

HANDLE RETRACTOR

ECARTEUR SUR MANCHE HOHMANN 8 X 220 MM
E012599 HOHMANN HANDLE RETRACTOR 8 X 220 MM

ECARTEUR SUR MANCHE HOHMANN 18 X 240 MM
E012602 HOHMANN HANDLE RETRACTOR 18 X 240 MM

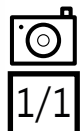
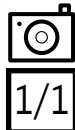

ECARTEUR SUR MANCHE HOHMANN 18 X 240 MM COUDE A 45°

E012603 HOHMANN HANDLE RETRACTOR 18 X 240 MM ANGLED 45°

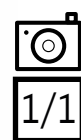

ECARTEUR SUR MANCHE
HOHMANN 43 X 240 MM

E012600 HOHMANN HANDLE
RETRACTOR 43 X 240 MM

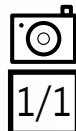

ECARTEUR SUR MANCHE HOHMANN 70 X 240 MM

E012601 HOHMANN HANDLE RETRACTOR 70 X 240 MM

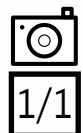

ECARTEUR SUR MANCHE

HANDLE RETRACTOR

ECARTEUR SUR MANCHE
HOHMANN 24 X 265 MM

E012607 HOHMANN HANDLE
RETRACTOR 24 X 265 MM

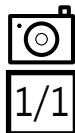

ECARTEUR SUR MANCHE HOHMANN
33 X 280 MM

E012608 HOHMANN HANDLE RETRACTOR
33 X 280 MM

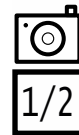

ECARTEUR SUR MANCHE
HOHMANN 22 X 260 MM

E012604 HOHMANN HANDLE
RETRACTOR
22 X 260 MM

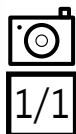

ECARTEUR SUR MANCHE
HOHMANN 22 X 260 MM
RAINURE

E012605 HOHMANN HANDLE
RETRACTOR 22 X 260 MM
GROOVE



ECARTEUR SUR MANCHE HOHMANN ALDIGER 24 X 270 MM

E012609 HOHMANN ALDIGER HANDLE RETRACTOR 24 X 270 MM



ECARTEUR SUR MANCHE HOSEL
30 X 100 X 250 MM

E012612 HOSEL HANDLE RETRACTOR
30 X 100 X 250 MM



E012610
20 X 60 MM



E012611
30 X 80 MM



E012613
30 X 120 MM



E012614
30 X 140 MM



E012615
40 X 140 MM



ECARTEUR SUR MANCHE ISRAEL
40 X 40 X 250 MM 4 GRIFFES

E012617 ISRAEL HANDLE RETRACTOR
40 X 40 X 250 MM 4 TEETH



E012618
45 X 50 X 250 MM
5 GRIFFES
5 TEETH

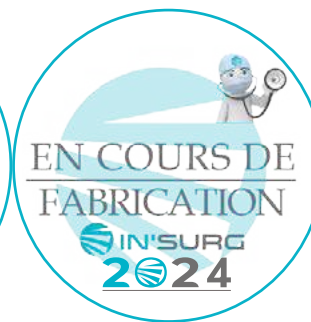

E012619
50 X 60 X 250 MM
6 GRIFFES
6 TEETH



E012620
70 X 70 X 250 MM
6 GRIFFES
6 TEETH

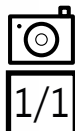

ECARTEUR SUR MANCHE JUDET
30 X 60 X 300 MM A BEC

E012621 *JUDET HANDLE RETRACTOR*
30 X 60 X 300 MM WITH NOSE



ECARTEUR SUR MANCHE KLAPP VALUDE
175 MM 2 GRIFFES MOUSSES

E012623 *KLAPP VALUDE HANDLE RETRACTOR*
175 MM 2 TEETH BLUNT



E012623
175 MM - 2 GRIFFES
2 TEETH



E012624
175 MM - 3 GRIFFES
3 TEETH

ECARTEUR SUR MANCHE KOCHER 25 X 60 X 230 MM

E012632 KOCHER HANDLE RETRACTOR 25 X 60 X 230 MMLONGUEUR
LENGTH

190 MM

220 MM

230 MM

E012625

12 X 19 MM

E012626

8 X 35 MM

E012635

18 X 40 MM

E012627

11 X 40 MM

E012636

20 X 60 MM

E012628

15 X 40 MM

E012632

25 X 60 MM

E012629

11 X 55 MM

E012633

30 X 75 MM

E012630

14 X 70 MM

E012634

40 X 76 MM

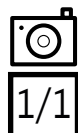

ECARTEUR SUR MANCHE KORTE 230 MM

E012637 KORTE HANDLE RETRACTOR 230 MM



ECARTEUR SUR MANCHE MARTIN
27 X 105 X 260 MM

E012656 MARTIN HANDLE RETRACTOR
27 X 105 X 260 MM



ECARTEUR SUR MANCHE LANGENBECK 10 X 30 X 210 MM

E012639 LANGENBECK HANDLE RETRACTOR 10 X 30 X 210 MM

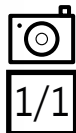

E012639
10 X 30 MM



E012646
16 X 30 MM



E012640
10 X 40 MM



E012641
10 X 50 MM



E012638
7 X 35 MM



E012642
13 X 43 MM



E012643
14 X 30 MM



E012644
14 X 33 MM

ECARTEUR SUR MANCHE LANGENBECK
15 X 85 X 210 MM

E012645 LANGENBECK HANDLE RETRACTOR
15 X 85 X 210 MM

ECARTEUR SUR MANCHE LANGENBECK
20 X 63 X 210 MM

E012649 LANGENBECK HANDLE RETRACTOR
20 X 63 X 210 MM

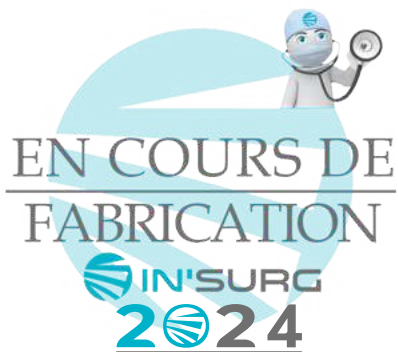

ECARTEUR SUR MANCHE

HANDLE RETRACTOR

ECARTEUR SUR MANCHE
LANGENBECK MANNERFELDT 6 X 20 X 150 MM

E012650 LANGENBECK MANNERFELDT
HANDLE RETRACTOR 6 X 20 X 150 MM



E012651
6 X 25 MM



ECARTEUR SUR MANCHE LOVE
210 MM BAIONNETTE

E012652 LOVE HANDLE RETRACTOR
210 MM BAYONET



ECARTEUR SUR MANCHE LOVE 190 MM COUDE A 45°
E012653 LOVE HANDLE RETRACTOR 190 MM ANGLED 45°



E012655
190 MM DROIT
STRAIGHT

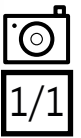

E012654
190 MM COUDE A 90°
ANGLED 90°

ECARTEUR SUR MANCHE

HANDLE RETRACTOR

ECARTEUR SUR MANCHE MAURER
30 X 270 MM

E012657 MAURER HANDLE RETRACTOR
30 X 270 MM



ECARTEUR SUR MANCHE MERLE D'AUBIGNE
CONTRE COUDE

E012668 MERLE D'AUBIGNE HANDLE RETRACTOR
COUNTER ANGLED



ECARTEUR SUR MANCHE MERLE D'AUBIGNE 12 X 35 X 180 MM

E012659 MERLE D'AUBIGNE HANDLE RETRACTOR 12 X 35 X 180 MM



LONGUEUR
LENGTH

150 MM 180 MM 200 MM

E012658 **E012659** **E012660**
10 X 30 MM 12 X 35 MM 16 X 60 MM

E012661
20 X 60 MM

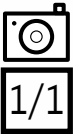

ECARTEUR SUR MANCHE MERLE D'AUBIGNE 30 X 90 X 250 MM

E012664 MERLE D'AUBIGNE HANDLE RETRACTOR 30 X 90 X 250 MM



LONGUEUR
LENGTH
250 MM

E012663 **E012662**
30 X 60 MM 20 X 90 MM

E012666 **E012664**
50 X 70 MM 30 X 90 MM

E012665
30 X 110 MM

E012667
50 X 110 MM

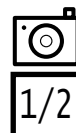

ECARTEUR SUR MANCHE MEYERDING 16 X 50 X 230 MM

E012669 MEYERDING HANDLE RETRACTOR 16 X 50 X 230 MM

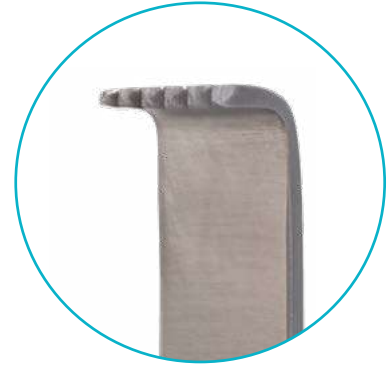

E012670

25 X 75 MM

E012671

50 X 90 MM



ECARTEUR SUR MANCHE MIDDELDORPF 14 X 17 X 215 MM MANCHE FENETRE
E012672 *MIDDELDORPF HANDLE RETRACTOR 14 X 17 X 215 MM FENESTRATED HANDLE*

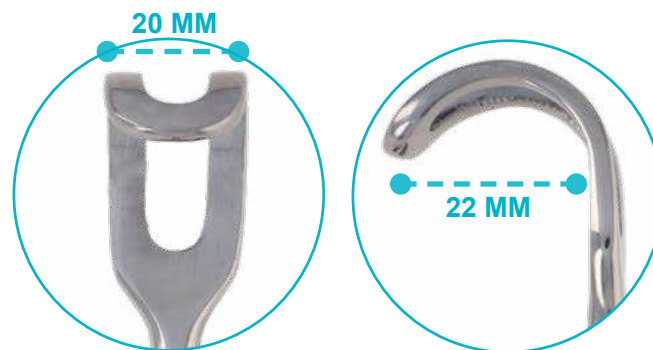

E012673
20 X 22 X 220 MM

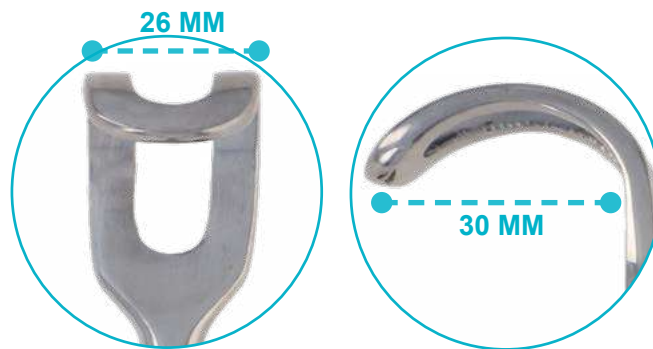

E012674
26 X 30 X 235 MM

ECARTEUR SUR MANCHE MIKULICZ 50 X 90 X 260 MM

E012676 MIKULICZ HANDLE RETRACTOR 50 X 90 X 260 MM



E012677

50 X 120 MM

E012678

50 X 155 MM

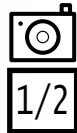

ECARTEUR SUR MANCHE MULLER 22 X 300 MM ANTERIEUR

E012679 MULLER HANDLE RETRACTOR 22 X 300 MM FRONT PATH

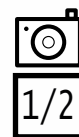

ECARTEUR SUR MANCHE MULLER 26 X 320 MM FEMORAL
E012682 *MULLER HANDLE RETRACTOR 26 X 320 MM FEMORAL*



ECARTEUR SUR MANCHE OBWERGESER 10 X 31 X 220 MM COURBE BAS

E012685 OBWERGESER HANDLE RETRACTOR 10 X 31 X 220 MM BOTTOM CURVED

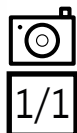

E012684
7 X 25 MM



E012685
10 X 31 MM



E012686
11 X 42 MM



E012687
12 X 55 MM



E012688
14 X 70 MM



E012689
16 X 80 MM

ECARTEUR SUR MANCHE OBWERGESER 12 X 60 X 220 MM COURBE HAUT

E012690 *OBWERGESER HANDLE RETRACTOR 12 X 60 X 220 MM HIGH CURVED*

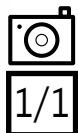

E012690
12 X 60 MM



E012691
13 X 42 MM



E012692
16 X 80 MM

ECARTEUR SUR MANCHE OBWERGESER
160 MM

E012683 *OBWERGESER HANDLE RETRACTOR
160 MM*



ECARTEUR SUR MANCHE OBWERGESER
160 MM SUPPORT MENTON

E012695 *OBWERGESER HANDLE RETRACTOR
160 MM CHIN REST*

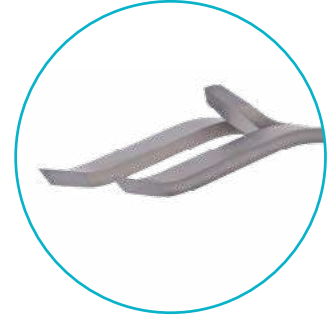

ECARTEUR SUR MANCHE OBWERGESER
11 X 70 X 220 MM RAMEAU

E012694 *OBWERGESER HANDLE RETRACTOR
11 X 70 X 220 MM BOUGH*



ECARTEUR SUR MANCHE OBWERGESER
9,5 X 44 X 220 MM EPINE NASALE

E012693 *OBWERGESER HANDLE RETRACTOR
9,5 X 44 X 220 MM FOR NASAL SPINE*



ECARTEUR SUR MANCHE OLLIER 50 x 60 x 230 MM 2 GRIFFES

E012702 OLLIER HANDLE RETRACTOR 50 X 60 X 230 MM 2 TEETH



E012698
25 X 50 MM

E012699
35 X 50 MM

E012700
30 X 70 MM

E012701
45 X 50 MM

E012696
30 X 36 X 225 MM 3 GRIFFES
3 TEETH

E012697
36 X 60 X 225 MM 4 GRIFFES
4 TEETH

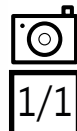

ECARTEUR SUR MANCHE PAUL 8 X 11 X 120 MM
E012703 PAUL HANDLE RETRACTOR 8 X 11 X 120 MM



ECARTEUR SUR MANCHE POSTEL
50 X 115 X 210 MM

E012711 POSTEL HANDLE RETRACTOR
50 X 115 X 210 MM



ECARTEUR SUR MANCHE RICHARDSON 20 X 28 X 240 MM

E012712 RICHARDSON HANDLE RETRACTOR 20 X 28 X 240 MM



E012713
22 X 54 MM

E012714
28 X 30 MM

E012715
37 X 38 MM

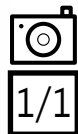

**ECARTEUR SUR MANCHE ROLLET
130 MM 4 GRIFFES POINTUES**

E012716 *ROLLET HANDLE RETRACTOR
130 MM 4 TEETH SHARP*



**ECARTEUR SUR MANCHE 150 MM
SCAPHOID**

E012722 *HANDLE RETRACTOR 150 MM
FOR SCAPHOID*

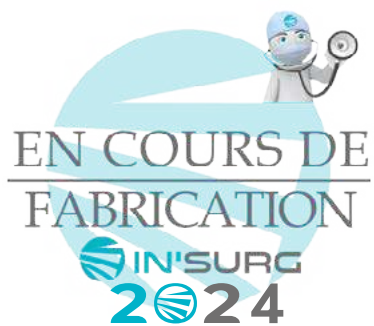

ECARTEUR SUR MANCHE SAUERBRUCH 15 X 45 X 225 MM

E012717 SAUERBRUCH HANDLE RETRACTOR 15 X 45 X 225 MM



E012718
20 X 72 X 225 MM



E012719
23 X 55 X 225 MM

EN COURS DE
FABRICATION
IN'SURG
2024

E012720
38 X 130 X 250 MM

EN COURS DE
FABRICATION
IN'SURG
2024

E012721
38 X 160 X 250 MM



ECARTEUR SUR MANCHE SCHONBORN 5 X 13 X 210 MM
E012723 SCHONBORN HANDLE RETRACTOR 5 X 13 X 210 MM



ECARTEUR SUR MANCHE

HANDLE RETRACTOR

ECARTEUR SUR MANCHE SCOVILLE
8 X 200 MM ANGULE

E012724 *SCOVILLE HANDLE RETRACTOR
8 X 200 MM ANGULED*

ECARTEUR SUR MANCHE SCOVILLE
8 X 230 MM DROIT

E012725 *SCOVILLE HANDLE RETRACTOR
8 X 230 MM STRAIGHT*



ECARTEUR SUR MANCHE SENN GREEN
6 X 10 X 160 MM

E012726 SENN GREEN HANDLE RETRACTOR
6 X 10 X 160 MM



ECARTEUR SUR MANCHE SIMON
22 X 115 MM

E012728 SIMON HANDLE RETRACTOR
22 X 115 MM



ECARTEUR SUR MANCHE

HANDLE RETRACTOR

ECARTEUR SUR MANCHE SMILLIE TRILLAT
12 X 150 MM COURBE

E012729 *SMILLIE TRILLAT HANDLE RETRACTOR
12 X 150 MM CURVED*



ECARTEUR SUR MANCHE SMILLIE TRILLAT
20 X 70 X 150 MM COUDE

E012733 *SMILLIE TRILLAT HANDLE RETRACTOR
20 X 70 X 150 MM ANGLED*



E012730
20 X 50 X 150 MM

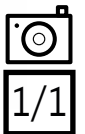

ECARTEUR SUR MANCHE SMILLIE TRILLAT
20 X 50 X 150 MM DOUBLE COURBURE

E012731 SMILLIE TRILLAT HANDLE RETRACTOR
20 X 50 X 150 MM DOUBLE CURVATURE



E012732
20 X 70 MM

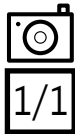

ECARTEUR SUR MANCHE STRANDELL STILLE
190 MM DENTES

E012735 STRANDELL STILLE HANDLE RETRACTOR
190 MM TOOTHED

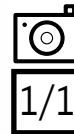

E012735
190 MM DENTES
TOOTHED



E012736
190 MM LISSE
SMOOTH

ECARTEUR SUR MANCHE TAYLOR 30 X 100 X 170 MM POUR RACHIS

E012738 TAYLOR HANDLE RETRACTOR 30 X 100 X 170 MM FOR SPINE



ECARTEUR SUR MANCHE TAYLOR 30 X 75 X 170 MM
POUR RACHIS

E012737 TAYLOR HANDLE RETRACTOR 30 X 75 X 170 MM
FOR SPINE

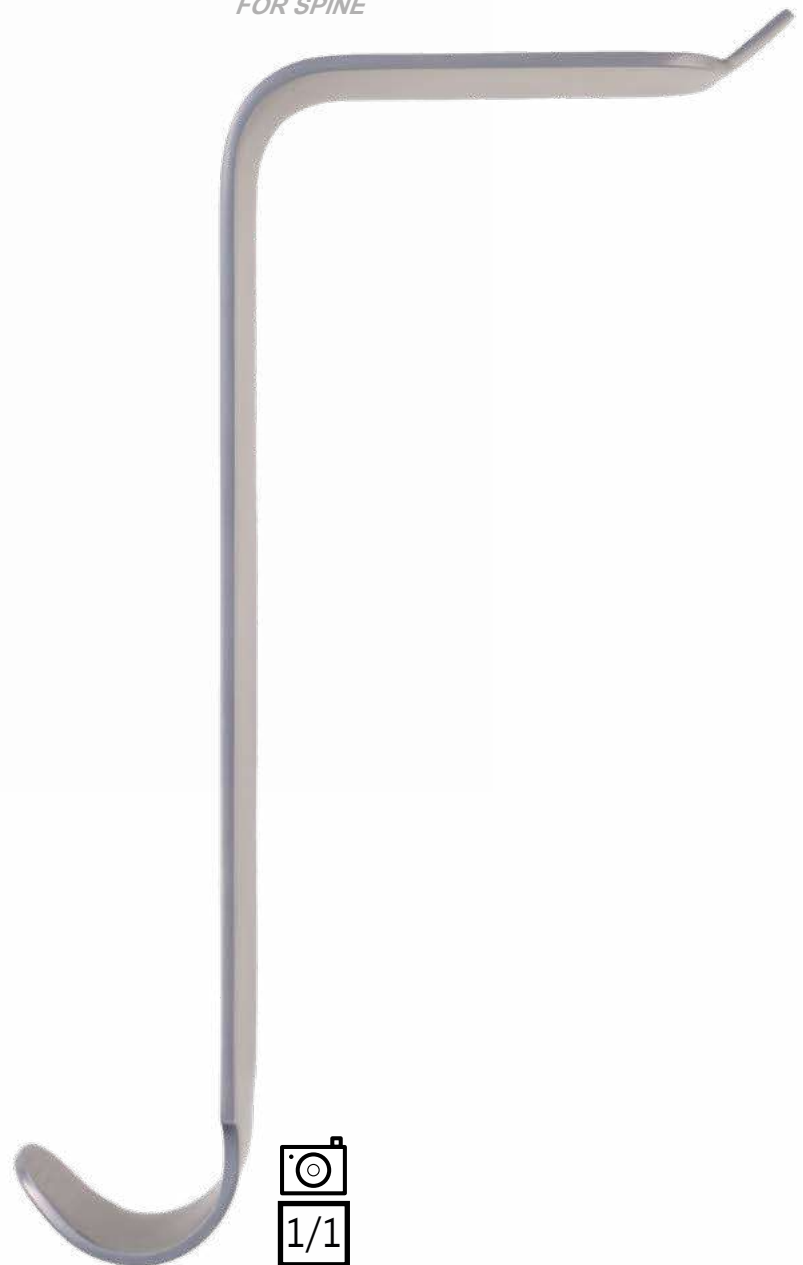

ECARTEUR SUR MANCHE VOLKMANN 160 MM GRAND MANCHE 2 GRIFFES MOUSSES

E012742 VOLKMANN HANDLE RETRACTOR 160 MM BIG HANDLE 2 TEETH BLUNT



LONGUEUR
LENGTH

160 MM

220 MM



GRIFFES MOUSSES

TEETH BLUNT

2 GRIFFES 2 TEETH	3 GRIFFES 3 TEETH	4 GRIFFES 4 TEETH	5 GRIFFES 5 TEETH	6 GRIFFES 6 TEETH
----------------------	----------------------	----------------------	----------------------	----------------------

E012742	E012746	E012750	E012754	E012757
E012743	E012747	E012751	E012755	E012758



GRIFFES POINTUES

TEETH SHARP

2 GRIFFES 2 TEETH	3 GRIFFES 3 TEETH	4 GRIFFES 4 TEETH	5 GRIFFES 5 TEETH	6 GRIFFES 6 TEETH
----------------------	----------------------	----------------------	----------------------	----------------------

LONGUEUR
LENGTH

160 MM

220 MM

E012744	E012748	E012752	E012756	E012759
E012745	E012749	E012753	E012760	E012761

ECARTEUR SUR MANCHE VOLKMANN 220 MM MANCHE FENETRE 2 GRIFFES MOUSSES
E012764 VOLKMANN HANDLE RETRACTOR 220 MM HANDLE FENESTRATED 2 TEETH BLUNT



GRIFFES MOUSSES
TEETH BLUNT

1 GRIFFE	2 GRIFFES	3 GRIFFES	4 GRIFFES	6 GRIFFES	8 GRIFFES
<i>1 TOOTH</i>	<i>2 TEETH</i>	<i>3 TEETH</i>	<i>4 TEETH</i>	<i>6 TEETH</i>	<i>8 TEETH</i>

LONGUEUR
LENGTH

220 MM

E012762	E012764	E012766	E012768	E012770	E012772
----------------	----------------	----------------	----------------	----------------	----------------



GRIFFES POINTUES
TEETH SHARP

1 GRIFFE	2 GRIFFES	3 GRIFFES	4 GRIFFES	6 GRIFFES
<i>1 TOOTH</i>	<i>2 TEETH</i>	<i>3 TEETH</i>	<i>4 TEETH</i>	<i>6 TEETH</i>

LONGUEUR
LENGTH

220 MM

E012763	E012765	E012767	E012769	E012771
----------------	----------------	----------------	----------------	----------------

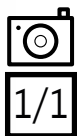

ECARTEUR SUR MANCHE VOLKMANN 160 MM PETIT MANCHE 2 GRIFFES POINTUES

E012777 VOLKMANN HANDLE RETRACTOR 160 MM HANDLE SMALL 2 TEETH SHARP

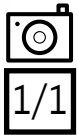

GRIFFES MOUSSES

TEETH BLUNT

LONGUEUR LENGTH	1 GRIFFE 1 TOOTH	2 GRIFFES 2 TEETH	3 GRIFFES 3 TEETH	4 GRIFFES 4 TEETH
160 MM	E012774	E012776	E012778	E012780



GRIFFES POINTUES

TEETH SHARP

LONGUEUR LENGTH	1 GRIFFE 1 TOOTH	2 GRIFFES 2 TEETH	3 GRIFFES 3 TEETH	4 GRIFFES 4 TEETH
160 MM	E012775	E012777	E012779	E012781

ECARTEUR SUR MANCHE VOLKMANN 150 MM TIGE RESSORT 2 GRIFFES MOUSSES
E012782 VOLKMANN HANDLE RETRACTOR 150 MM SPRING-LOADED ROD 2 TEETH BLUNT

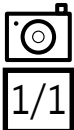

GRIFFES MOUSSES
 TEETH BLUNT

LONGUEUR LENGTH	2 GRIFFES 2 TEETH	3 GRIFFES 3 TEETH	4 GRIFFES 4 TEETH
	150 MM	E012782	
160 MM		E012784	E0127686



GRIFFES POINTUES
 TEETH SHARP

LONGUEUR LENGTH	2 GRIFFES 2 TEETH	3 GRIFFES 3 TEETH	4 GRIFFES 4 TEETH
	160 MM	E012783	E012785

ECARTEUR SUR MANCHE

HANDLE RETRACTOR

ECARTEUR SUR MANCHE WAGNER
17 X 220 MM

E012788 *WAGNER HANDLE RETRACTOR
17 X 220 MM*

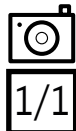

ECARTEUR SUR MANCHE SCHUMACHER
18 X 37 X 345 MM

E012789 *SCHUMACHER HANDLE RETRACTOR
18 X 37 X 345 MM*

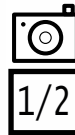

ECARTEUR SUR MANCHE ZENKER
8 X 35 X 250 MM

E012790 ZENKER HANDLE RETRACTOR
8 X 35 X 250 MM



E012791
12 X 60 MM

E012792
12 X 75 MM

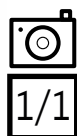

ECARTEUR SUR MANCHE
MODIFIE TUBIANA 20 X 50 X 160 MM

E012793 TUBIANA RETRACTOR ON HANDLE
MODIFIED 20 X 50 X 160 MM

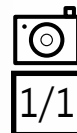

ECARTEUR ABDOMINAL ABADIE 22 X 30 MM

E022793 ABADIE ABDOMINAL RETRACTOR 22 X 30 MM

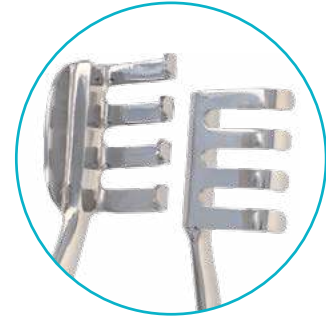

1/1

CADRE POUR ECARTEUR ABDOMINAL AUVERT
260 X 340 MM L'UNITE

E022796 *FRAME FOR ABDOMINAL RETRACTOR AUVERT
260 X 340 MM UNIT*

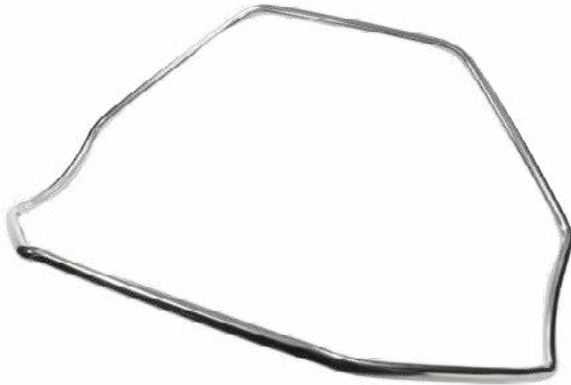

VALVE PR ECARTEUR ABDOMINAL AUVERT
30 X 60 MM

E022794 *VALVE FOR AUVERT ABDOMINAL
RETRACTOR 30 X 60 MM*



CURSEUR PORTE VALVE POUR
ECARTEUR ABDOMINAL AUVERT L'UNITE

E022797 *VALVE HOLDER SLIDER FOR ABDOMINAL
RETRACTOR AUVERT UNIT*



VALVE PR ECARTEUR ABDOMINAL AUVERT
50 X 80 MM

E022795 *VALVE FOR AUVERT ABDOMINAL
RETRACTOR 50 X 80 MM*

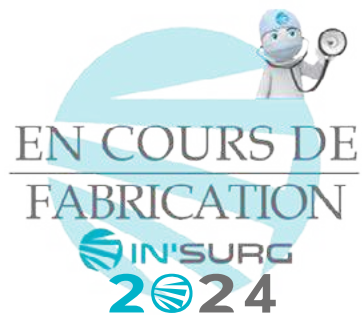

ECARTEUR ABDO. BALFOUR VALVES LAT. 100 MM MEDIANE 100 x 70 MM OUVERTURE MAX 200 MM
E022802 ABDOMINAL RETRACTOR BALFOUR VALVES LAT. 100 MM MEDIAN 100 X 70 MM MAX. OPENING 200 MM MAX



REFERENCES ITEMS	OUVERTURE MAX MAX OPENING	VALVES LATERALES LATERAL VALVES	VALVE MEDIANE MEDIAN VALVE
E022798	90 MM	27 MM	25 X 25 MM
E022799	180 MM	70 MM	80 X 45 MM
E022801	200 MM	100 MM	85 X 70 MM
E022802	200 MM	100 MM	100 X 70 MM
E022803	250 MM	100 MM	85 X 70 MM

ECARTEUR ABDO. BALFOUR OUVERTURE MAX 180 MM VALVES PLEINES
E022800 ABDOMINAL RETRACTOR BALFOUR MAX OPENING 180 MM FULL VALVES



ECARTEUR ABDO. BALFOUR OUVERTURE MAX 200 MM VALVES PLEINES
E022804 ABDOMINAL RETRACTOR BALFOUR MAX OPENING 200 MM FULL VALVES

CADRE COMPLET PR ECARTEUR ABDO. BERGERET

E022812 BERGERET ABDOMINAL FRAME RETRACTOR COMPLETE

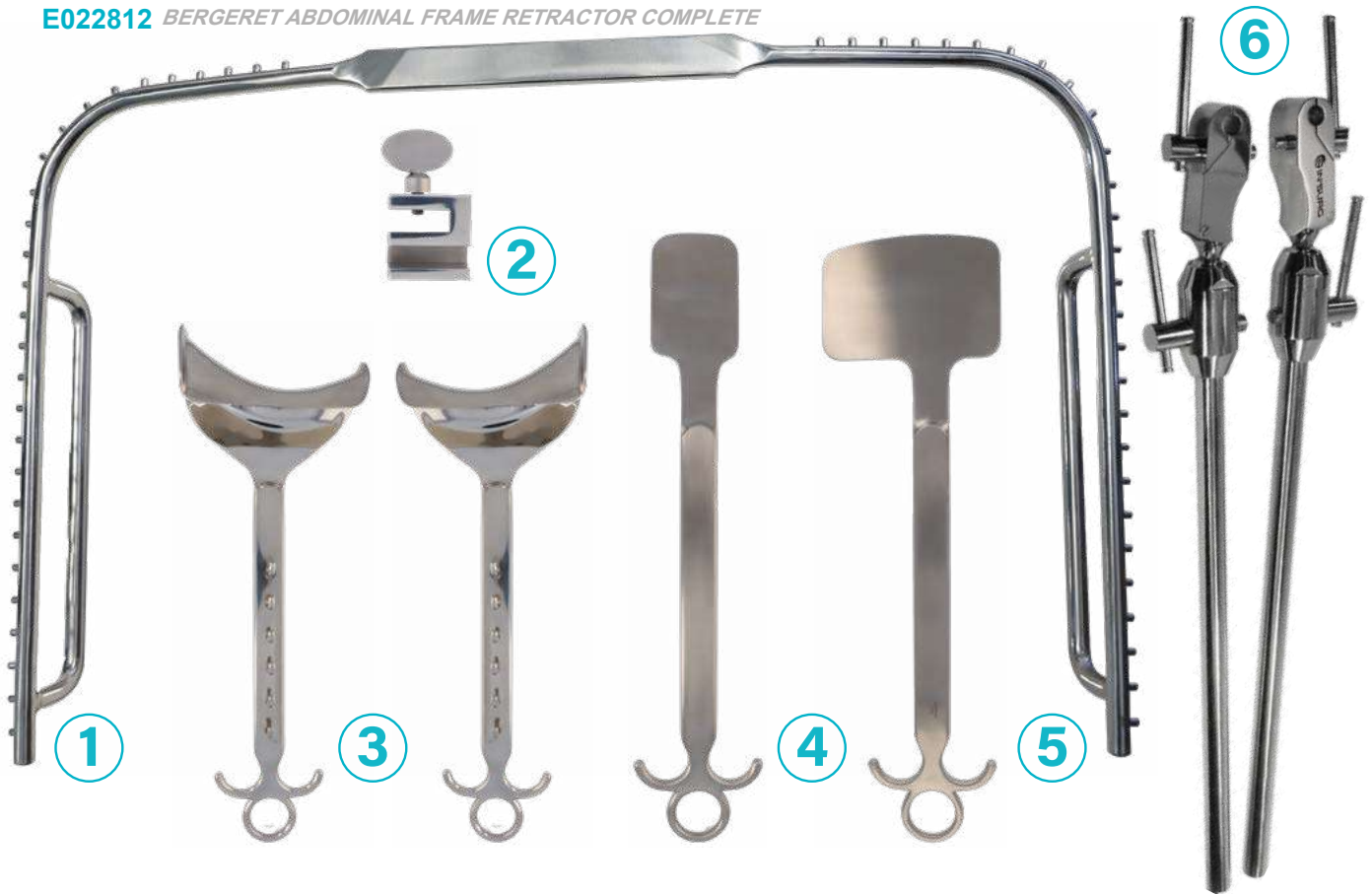

1

E022813

CADRE PR ECARTEUR ABDO.
BERGERET L'UNITEFRAME FOR BERGERET ABDOMINAL
RETRACTOR UNIT

2

E022814

CURSEUR PORTE VALVE A FOIE
PR ECARTEUR ABDO.
BERGERETVALVE HOLDER SLIDER FOR ABDOMINAL
RETRACTOR BERGERET FOR LIVER VALVE

3

E022815

PAIRE DE VALVES LAT. PR
ECARTEUR ABDO. BERGERET
100 x 50 MMPAIR OF VALVES FOR BERGERET ABDOMINAL
RETRACTOR 50 X 100 MM

4

E022816

VALVE PR ECARTEUR ABDO.
BERGERET 50 MM MALLEABLE
A FOIEPAIR OF LIVER VALVES FOR BERGERET
ABDOMINAL RETRACTOR 50 MM
MALLEABLE TO LIVER

5

E022817

VALVE PR ECARTEUR ABDO.
BERGERET 80 MM MALLEABLE
A FOIEPAIR OF LIVER VALVES FOR BERGERET
ABDOMINAL RETRACTOR 80 MM
MALLEABLE TO LIVER

6

E022942

PAIRE DE PIQUETS A ROTULES
470 MM POUR ECARTEUR
ABDO. BERGERETPAIR OF FLEX BARRS FOR BERGERET
ABDOMINAL RETRACTOR

ECARTEUR ABDO. COLLIN BABY 180 MM AV 2 PAIRES DE VALVES 23 X 44 MM ET 30 X 44 MM

E022818 COLLIN BABY ABDOMINAL RETRACTOR 180 MM WITH 2 PAIR OF BLADES 23 X 44 MM AND 30 X 44 MM

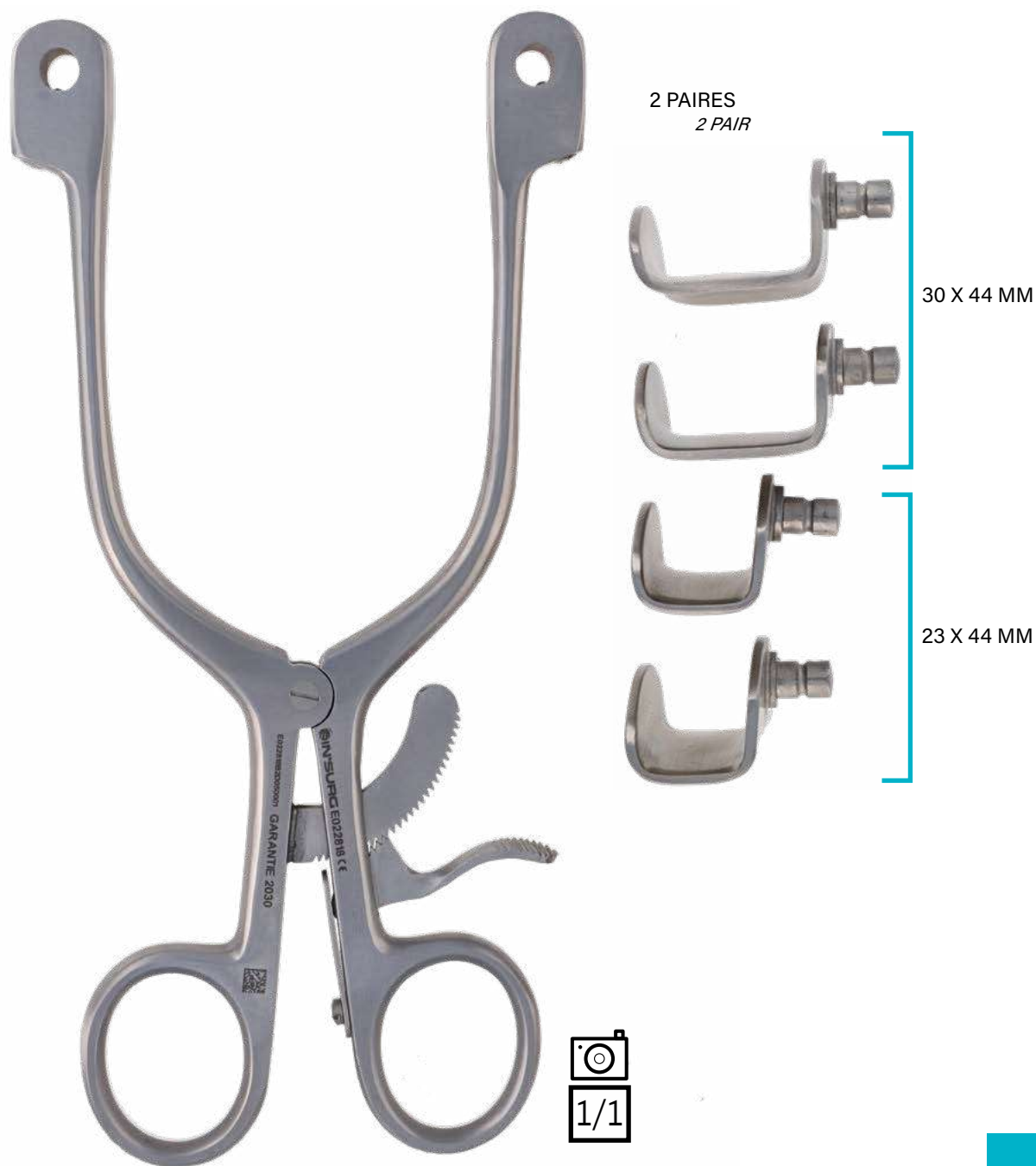

ECARTEUR ABDOMINAL

ABDOMINAL RETRACTOR

COMPAS PR ECARTEUR ABDO. COTTE 125 X 200 MM
L'UNITE

E022823 COMPASS FOR COTTE ABDOMINAL RETRACTOR
125 X 200 MM UNIT



E022824
280 X 230 MM

VALVE MEDIANE PR ECARTEUR ABDO.
COTTE 75 x 85 MM

E022822 MEDIAN VALVE FOR COTTE
ABDOMINAL RETRACTOR
75 X 85 MM



VALVE LAT. PR ECARTEUR ABDO. COTTE
50 X 40 MM L'UNITE

E022819 LATERAL VALVE FOR COTTE ABDOMINAL
RETRACTOR 50 X 40 MM UNIT

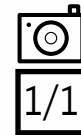

E022820
80 X 45 MM

E022821
80 X 55 MM



ECARTEUR ABDO. COMPLET DENIS BROWN ENFANT

E022825 DENIS BROWN RETRACTOR COMPLETE FOR CHILDREN



- | | | | |
|-----------------|-----------------------|--|---|
| <p>1</p> | <p>E022826</p> | <p>CADRE PR ECARTEUR ABDO. DENIS BROWN 180 X 150 MM ENFANT</p> | <p>FRAME FOR DENIS BROWN ABDOMINAL RETRACTOR 180 X 150 MM CHILDREN</p> |
| <p>2</p> | <p>E022827</p> | <p>PAIRE DE VALVES PR ECARTEUR ABDO. DENIS BROWN 30 X 40 MM ENFANT</p> | <p>PAIR OF VALVES FOR DENIS BROWN ABDOMINAL RETRACTOR 30 X 40 MM CHILDREN</p> |
| <p>3</p> | <p>E022828</p> | <p>PAIRE DE VALVES PR ECARTEUR ABDO. DENIS BROWN 35 X 40 MM ENFANT</p> | <p>PAIR OF VALVES FOR DENIS BROWN ABDOMINAL RETRACTOR 35 X 40 MM CHILDREN</p> |

ECARTEUR ABDO. DESMARET 65 X 370 MM OUVERTURE MAX 170 MM
E022829 DESMARET ABDOMINAL RETRACTOR 65 X 370 MM OPEN MAX 170 MM



COMPAS PR ECARTEUR ABDO. ROCHARD
 L'UNITE
E022888 ROCHARD ABDOMINAL RETRACTOR
 THE COMPASS UNIT

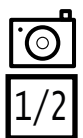
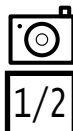

ECARTEUR ABDO. FOUCAULT OUVERTURE MIN 80 MM MAX 120 MM

E022830 FOUCAULT ABDOMINAL RETRACTOR OPEN MIN 80 MM MAX 120 MM

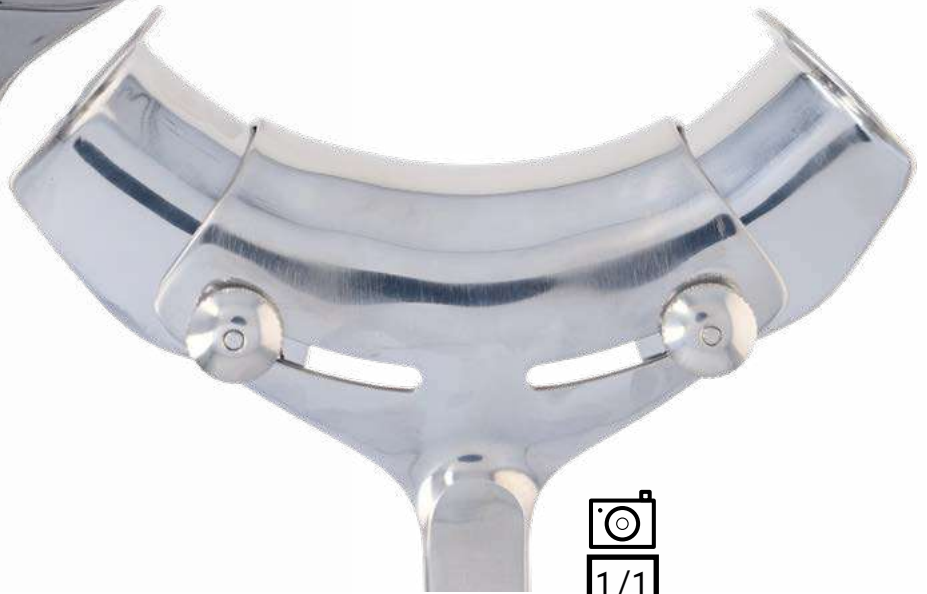
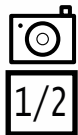

COMPAS PR ECARTEUR ABDO. ROCHARD L'UNITE

E022888 ROCHARD ABDOMINAL RETRACTOR THE COMPASS UNIT



ECARTEUR ABDO. GOSSET 45 X 60 X 200 MM AVEC CREMAILLERE

E022832 GOSSET ABDOMINAL RETRACTOR 45 X 60 X 200 MM WITH RATCHET

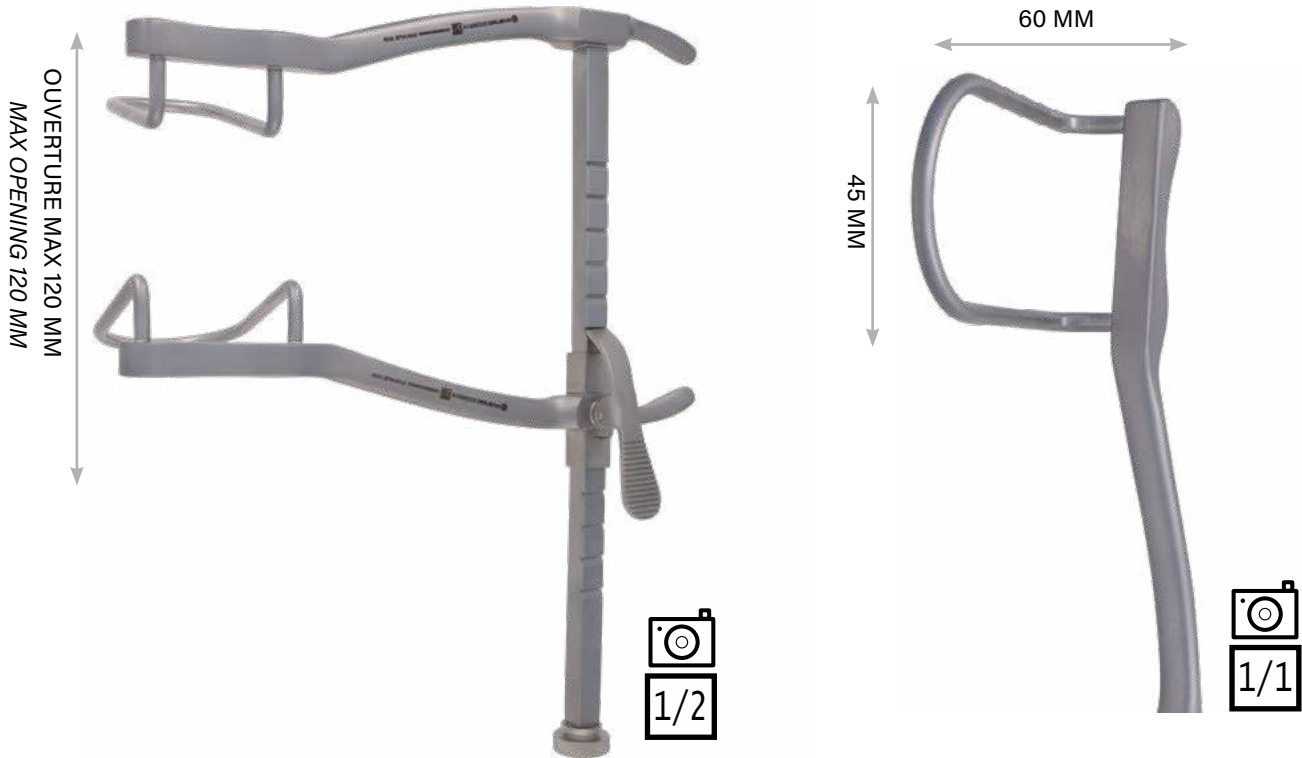

OUVERTURE MAX.
MAX. OPENING

DIMENSION
DIMENSION

E022831

150 MM

30 X 35 MM

E022832

200 MM

45 X 60 MM

E022833

300 MM

45 X 60 MM

E022834

300 MM

45 X 90 MM

PORTE VALVE MEDIANE PR ECARTEUR ABDO. GOSSET

E022838 VALVE MEDIAN HOLDER SLIDER FOR GOSSET ABDOMINAL RETRACTOR



ECARTEUR ABDO. GOSSET 45 X 60 X 200 MM SANS CREMAILLERE

E022836 *GOSSET ABDOMINAL RETRACTOR 45 X 60 X 200 MM WITHOUT RATCHET*

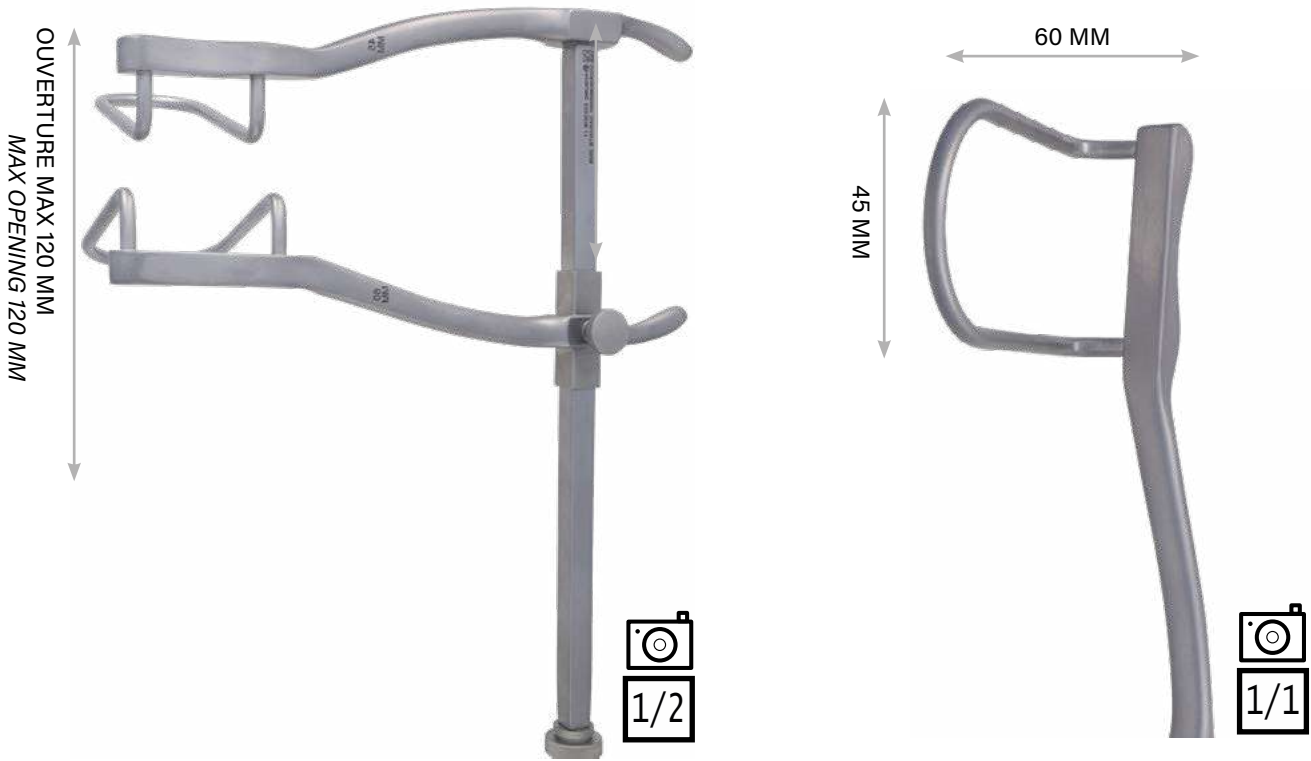

	OUVERTURE MAX. MAX. OPENING	DIMENSION DIMENSION
E022835	150 MM	30 X 35 MM
E022836	200 MM	45 X 60 MM
E022837	300 MM	45 X 60 MM

PORTE VALVE MEDIANE PR ECARTEUR ABDO. GOSSET

E022838 *VALVE MEDIAN HOLDER SLIDER FOR GOSSET ABDOMINAL RETRACTOR*



ECARTEUR ABDOMINAL

ABDOMINAL RETRACTOR

PAIRE DE PIQUETS PR ECARTEUR ABDO.
HAUTEFEUILLE 400 MM

E022839 PAIR OF STAKES FOR HAUTEFEUILLE
ABDOMINAL RETRACTOR 400 MM



E022840
500 MM

VALVE PR ECARTEUR ABDO. HAUTEFEUILLE
45 x 80 MM L'UNITE

E022841 VALVE FOR HAUTEFEUILLE ABDOMINAL
RETRACTOR 45 X 80 MM UNIT



E022842
50 X 100 MM

E022843
55 X 120 MM

COMPAS PR ECARTEUR ABDO. ROCHARD
L'UNITE

E022888 ROCHARD ABDOMINAL RETRACTOR
THE COMPASS UNIT



ECARTEUR ABDO. HRYNTSCHAK 115 MM ADULTE

E022844 HRYNTSCHAK ABDOMINAL RETRACTOR 115 MM ADULT



E022846
85 MM ENFANT
CHILDREN

VALVE MEDIANE ECARTEUR ABDO.HRYNTSCHAK
90 x 40 MM L'UNITE

E022847 VALVE MEDIAN FOR HRYNTSCHAK ABDOMINAL
RETRACTOR 90 X 40 MM UNIT



CURSEUR PR ECARTEUR ABDO. HRYNTSCHAK
L'UNITE

E022845 HOLDER SLIDER FOR HRYNTSCHAK
ABDOMINAL RETRACTOR UNIT



ECARTEUR ABDO. COMPLET JUDD MASSON

E022849 JUDD MASSON ABDOMINAL RETRACTOR COMPLETE

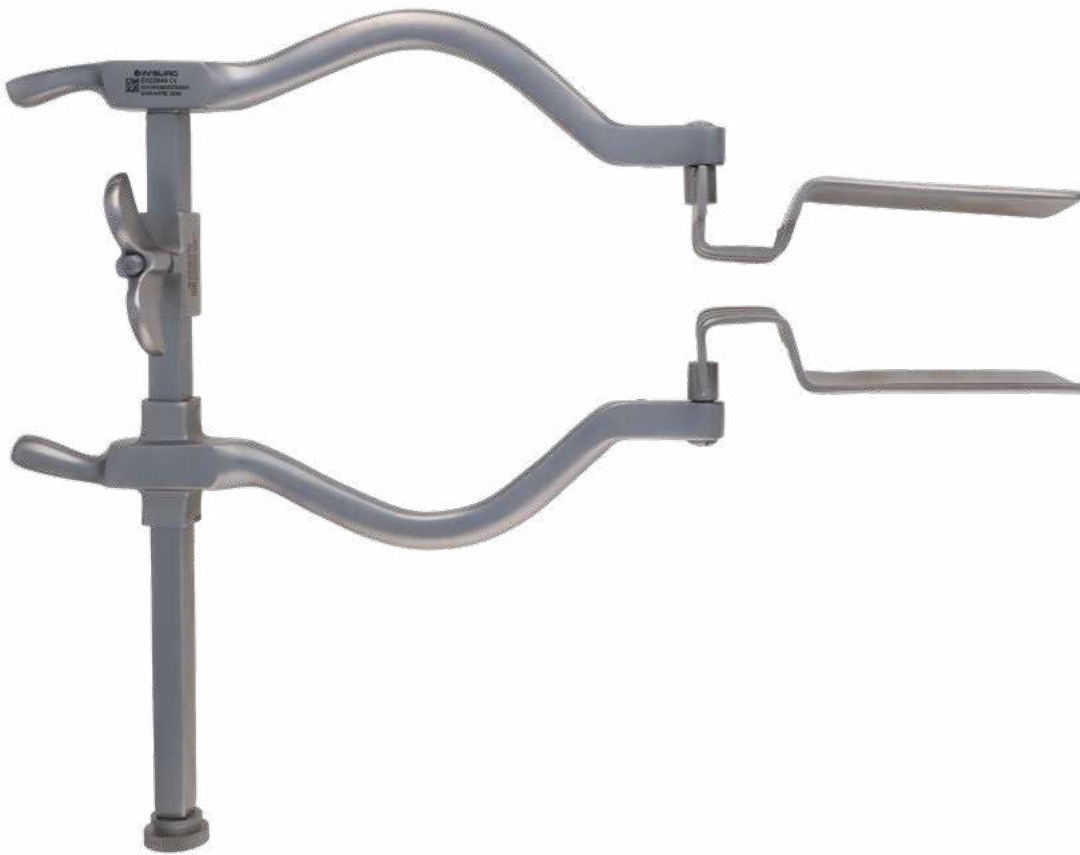

VALVE MEDIANE PR ECARTEUR ABDO. JUDD MASSON 25 X 75 MM

E022850 VALVE MEDIAN FOR JUDD MASSON ABDOMINAL RETRACTOR 25 X 75 MM



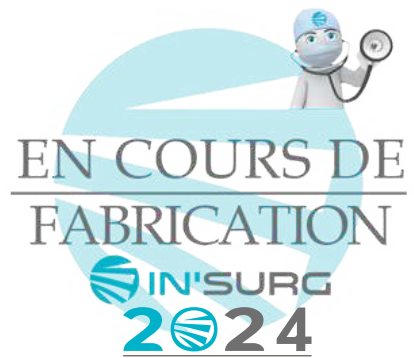

CADRE FIXE PR ECARTEUR ABDO. KIRSCHNER 250 X 250 MM

E022851 *FIXED FRAME FOR KIRSCHNER ABDOMINAL RETRACTOR 250 X 250 MM*

CADRE PLIANT PR ECARTEUR ABDO. KIRSCHNER 250 X 250 MM

E022852 *FOLDING FRAME FOR KIRSCHNER ABDOMINAL RETRACTOR 250 X 250 MM*



VALVE PR ECARTEUR ABDO. KIRSCHNER 50 X 40 MM

E022855 *VALVE FOR KIRSCHNER ABDOMINAL RETRACTOR 50 X 40 MM*

VALVE PR ECARTEUR ABDO. KIRSCHNER 60 X 50 MM

E022856 *VALVE FOR KIRSCHNER ABDOMINAL RETRACTOR 60 X 50 MM*

VALVE PR ECARTEUR ABDO. KIRSCHNER 80 X 65 MM

E022857 *VALVE FOR KIRSCHNER ABDOMINAL RETRACTOR 80 X 65 MM*

VALVE PR ECARTEUR ABDO. KIRSCHNER 80 X 80 MM

E022858 *VALVE FOR KIRSCHNER ABDOMINAL RETRACTOR 80 X 80 MM*

VALVE PR ECARTEUR ABDO. KIRSCHNER 90 X 65 MM

E022859 *VALVE FOR KIRSCHNER ABDOMINAL RETRACTOR 90 X 65 MM*

VALVE PR ECARTEUR ABDO. KIRSCHNER 90 X 90 MM

E022860 *VALVE FOR KIRSCHNER ABDOMINAL RETRACTOR 90 X 90 MM*

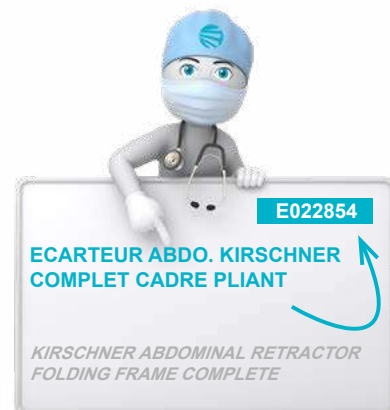
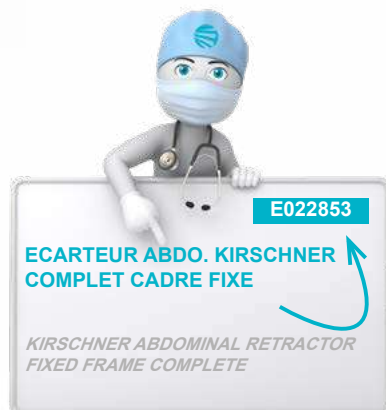

ECARTEUR ABDO. MILLIN VESICAL 290 MM

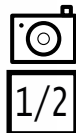
E022862 *MILLIN ABDOMINAL RETRACTOR FOR VESICAL 290 MM*

ECARTEUR ABDO. OLIVIER 75 X 45 MM VALVE SIMPLE
AV POIGNEE, CAPUCHON, CHAINE ET CROCHET

E022869 OLIVIER ABDOMINAL RETRACTOR 75 X 45 MM SINGLE VALVE
WITH HANDLE, CAPS, CHAIN AND HOOK

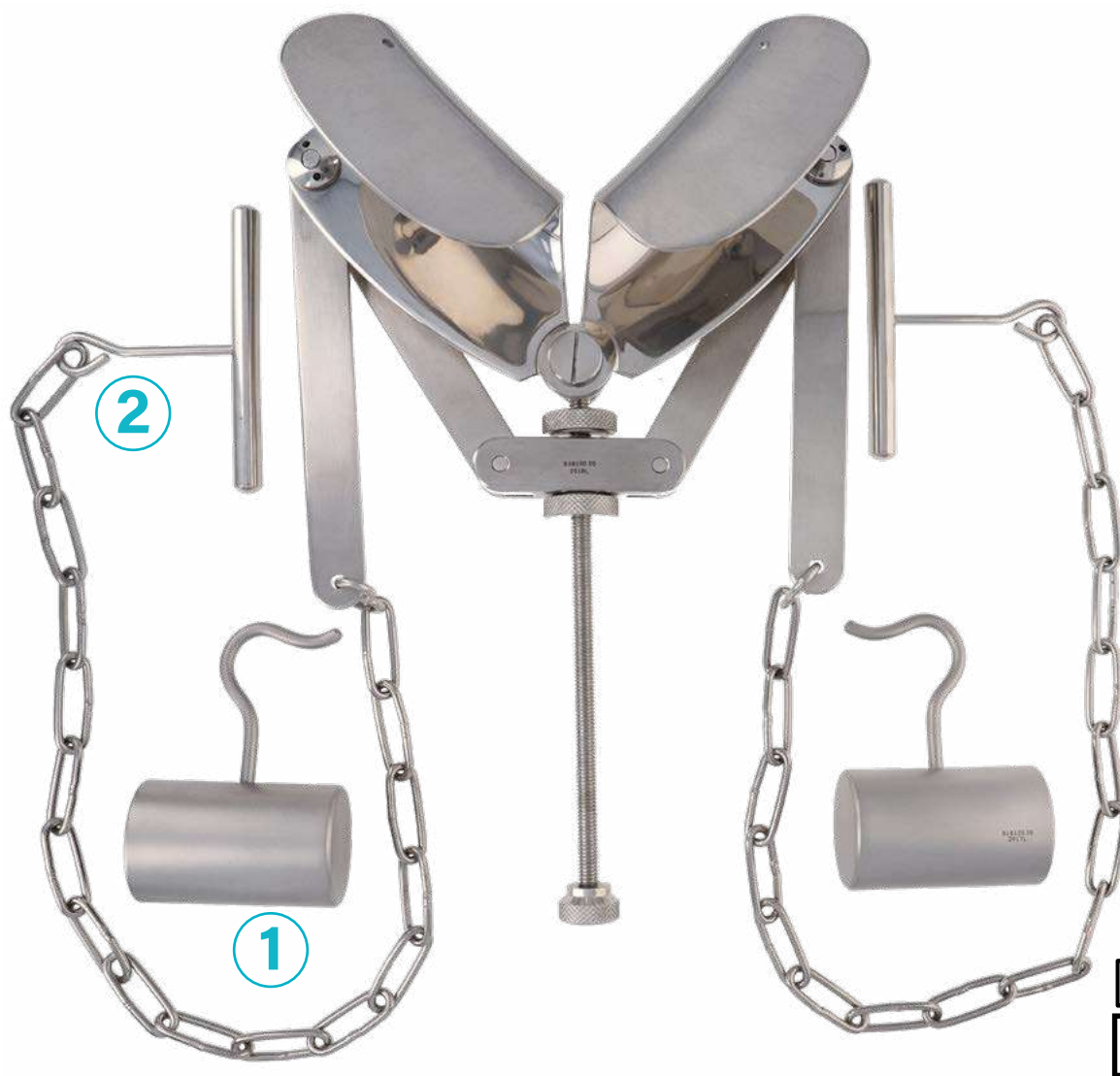

1 E022867 PAIRE DE CAPUCHON
PR ECARTEUR ABDO. OLIVIER

PAIR OF CAPS FOR OLIVIER
ABDOMINAL RETRACTOR

2 E022868 POIGNEE, CHAINE, CROCHET
PR ECARTEUR ABDO. OLIVIER
LE LOT

HANDLE, CHAIN, AND HOOK FOR
OLIVIER ABDOMINAL RETRACTOR
THE LOT

ECARTEUR ABDOMINAL

ABDOMINAL RETRACTOR



E022871

ECARTEUR ABDO.
COMPLET RICARD 3
VALVES DE 80 MM

RICARD ABDOMINAL RETRACTOR
WITH 3 VALVES 80 MM



1



2



3

COMPAS
COMPASS

DIMENSION
DIMENSION

DIMENSION
DIMENSION

REFERENCES
ITEMS

1

E022870

180 MM L'UNITE
THE UNIT

VALVE LATERALE

E022874

70 X 50 MM L'UNITE
THE UNIT

2

E022875

80 X 80 MM L'UNITE
THE UNIT

E022876

100 X 80 MM L'UNITE
THE UNIT

E022877

120 X 100 MM L'UNITE
THE UNIT

3

VALVE MEDIANE

E022881

70 X 50 MM L'UNITE
THE UNIT

E022882

80 X 80 MM L'UNITE
THE UNIT

E022883

100 X 80 MM L'UNITE
THE UNIT

E022880

65 X 85 MM L'UNITE
THE UNIT

E022884

120 X 100 MM L'UNITE
THE UNIT

DEPRESSEUR DE TOUPET DOUBLE PR
ECARTEUR ABDO. RICARD L'UNITE

E022872 *TOUPET DOUBLE DEPRESSOR FOR RICARD
ABDOMINAL RETRACTOR UNIT*



ENTEROSTAT DE TOUPET SIMPLE PR
ECARTEUR ABDO. RICARD L'UNITE

E022873 *TOUPET SINGLE ENTEROSTAT
FOR RICARD ABDOMINAL
RETRACTOR UNIT*



PORTE VALVE MEDIANE PR ECARTEUR ABDO. GOSSET

E022838 *VALVE MEDIAN HOLDER SLIDER FOR GOSSET ABDOMINAL RETRACTOR*



ECARTEUR ABDOMINAL

ABDOMINAL RETRACTOR

COMPAS PR ECARTEUR ABDO.
ROCHARD L'UNITE

E022888 ROCHARD ABDOMINAL RETRACTOR
THE COMPASS UNIT

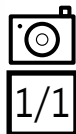

VALVE SUSPUBIENNE PR ECARTEUR ABDO.
ROCHARD 80 MM L'UNITE

E022885 SUSPIBIAN VALVE FOR ROCHARD
ABDOMINAL RETRACTOR 80 MM UNIT

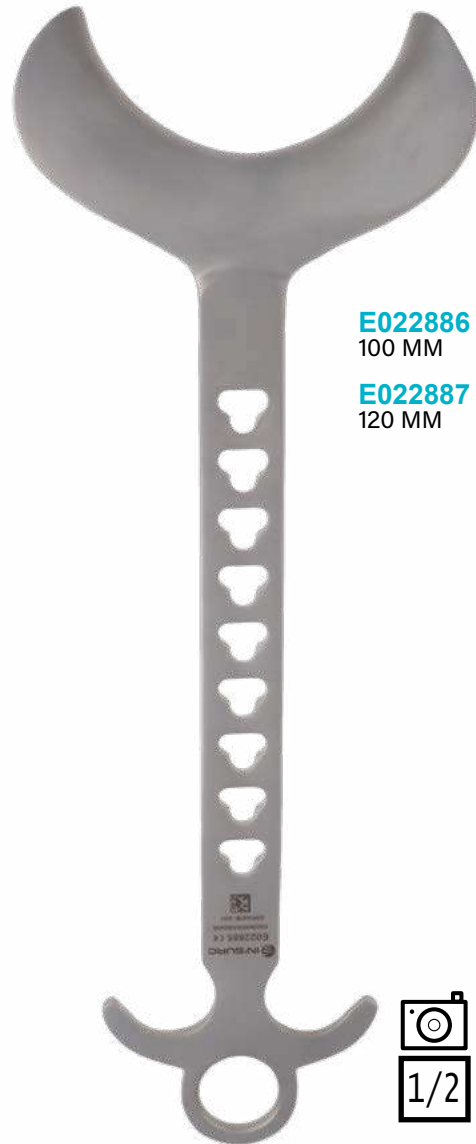

E022886
100 MM

E022887
120 MM

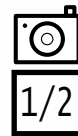

RALLONGE DE TIGE PR ECARTEUR ABDO.
ROCHARD 200 MM

E022892 SPINDLE EXTENSION ROCHARD
ABDOMINAL RETRACTOR 200 MM

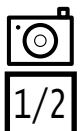
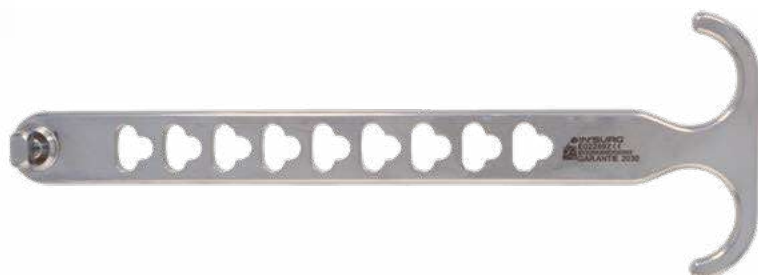

ECARTEUR ABDO. SMITH BUIE VALVE 22 X 70 X 150 MM PR RECTUM

E022895 SMITH BUIE ABDOMINAL RETRACTOR 22 X 70 X 150 MM FOR RECTUM

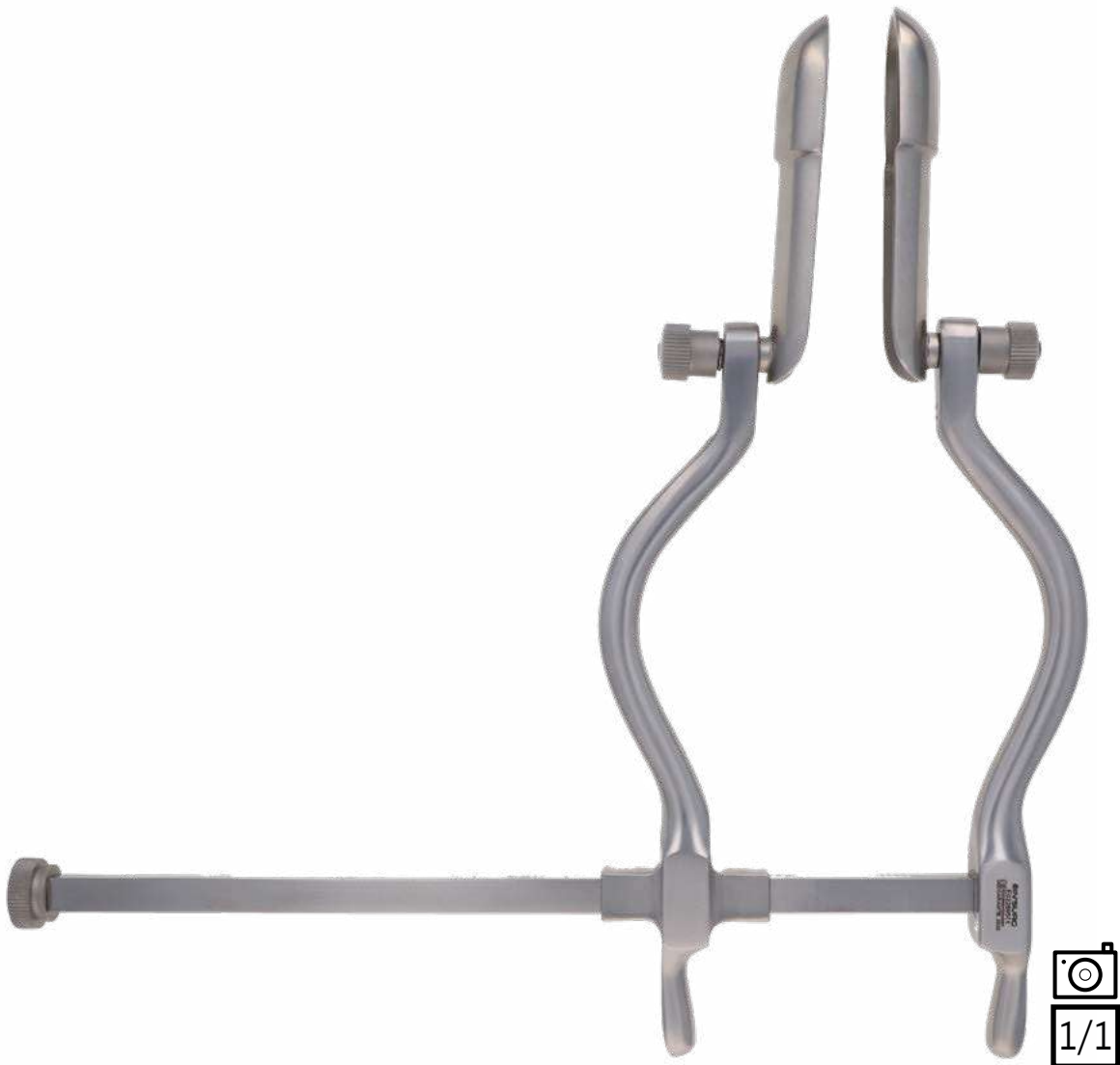

ECARTEUR ABDOMINAL

ABDOMINAL RETRACTOR

CHAINETTE PR ECARTEUR ABDO.
TOUPET LE METRE

E022896 CHAIN FOR TOUPET ABDOMINAL
RETRACTOR THE METER



CURSEUR PR ECARTEUR ABDO. TOUPET

E022897 HOLDER SLIDER FOR TOUPET
ABDOMINAL RETRACTOR



PAIRE DE PIQUETS PR ECARTEUR ABDO.
TOUPET 300 MM

E022899 PAIR OF PICKETS FOR TOUPET
ABDOMINAL RETRACTOR 300 MM



E022900
500 MM

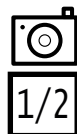

E022898

PORTE PIQUETS ET PAIRE DE
PIQUETS POUR ECARTEUR
ABDO. TOUPET 300 MM

PAIR OF PICKETS WITH PICKET
HOLDER FOR TOUPET ABDOMINAL
RETRACTOR

ECARTEUR AUTOSTATIQUE

www.in-surg.fr

E

AUTOSTATIC RETRACTOR

ECARTEUR AUTOSTATIQUE BANKART 2 X 2 GRIFFES

E032937 BANKART AUTOSTATIC RETRACTOR 2 X 2 TEETH

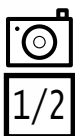

E032937
2 X 2 GRIFFES
2 X 2 TEETH



E032938
1 X 1 GRIFFE
1 X 1 TOOTH

ECARTEUR AUTOSTATIQUE BANKART 40 X 210 MM

E032939 BANKART AUTOSTATIC RETRACTOR 40 X 210 MM

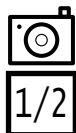

E032939
40 X 210 MM



E032940
60 X 210 MM

ECARTEUR AUTOSTATIQUE BANKART TRES COURBE

E032941 *BANKART AUTOSTATIC RETRACTOR VERY CURVED*

ECARTEUR AUTO. ADSON 290 MM
GRIFFES MOUSSES A DROITE PR
HEMILAMINECTOMIE

E033055 *ADSON AUTOSTATIC RETRACTOR
290 MM WITH RIGHT-TEETH BLUNT
FOR HEMILAMINECTOMY*



E033056
GRIFFES MOUSSES
A GAUCHE
LEFT-TEETH BLUNT

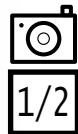

ECARTEUR AUTO. ADSON 290 MM
6 X 6 GRIFFES POINTUES PR
LAMINECTOMIE

E033054 *ADSON AUTOSTATIC RETRACTOR
290 MM 6 X 6 TEETH SHARP FOR
LAMINECTOMY*

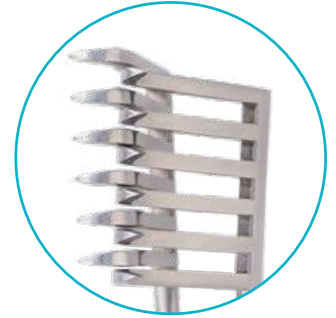

ECARTEUR AUTOSTATIQUE ADSON 20 x 200 MM COURBE POINTU
E032951 ADSON AUTOSTATIC RETRACTOR 20 X 200 MM CURVED SHARP



E032950

ECARTEUR AUTOSTATIQUE
 ADSON 32 x 190 MM DROIT
 MOUSSE

ADSON AUTOSTATIC RETRACTOR
 32 X 190 MM STRAIGHT BLUNT

EN COURS DE
 FABRICATION
 IN'SURG
 2024

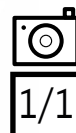

ECARTEUR AUTOSTATIQUE ADSON BECKMANN
25 X 25 X 320 MM MOUSSE

E032954 ADSON BECKMANN AUTOSTATIC
RETRACTOR 25 X 25 X 320 MM BLUNT



E032955
25 X 32 X 320 MM

E032956
25 X 38 X 320 MM

E032957
25 X 45 X 320 MM

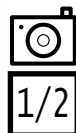

ECARTEUR AUTOSTATIQUE ADSON
BECKMANN 25 X 25 X 320 MM POINTU

E032958 ADSON BECKMANN AUTOSTATIC
RETRACTOR 25 X 25 X 320 MM
SHARP



E032959
25 X 32 X 320 MM

E032960
25 X 38 X 320 MM

E032961
25 X 45 X 320 MM

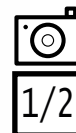

AUTOSTATIC RETRACTOR

ECARTEUR AUTOSTATIQUE
ALM 70 MM 4 x 4 GRIFFES
MOUSSES

E032962 *ALM AUTOSTATIC RETRACTOR 70 MM
4 X 4 TEETH BLUNT*

ECARTEUR AUTOSTATIQUE ALM
100 MM 4 x 4 GRIFFES POINTUES

E032965 *ALM AUTOSTATIC RETRACTOR
100 MM 4 X 4 TEETH SHARP*



E032963
100 MM

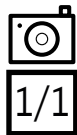

E032964
70 MM

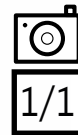

ECARTEUR AUTOSTATIQUE ADSON BECKMANN
35 x 270 MM COURBE POINTU

E032953

ADSON BECKMANN AUTOSTATIC
RETRACTOR 35 X 270 MM CURVED SHARP



E032952

MOUSSE
BLUNT

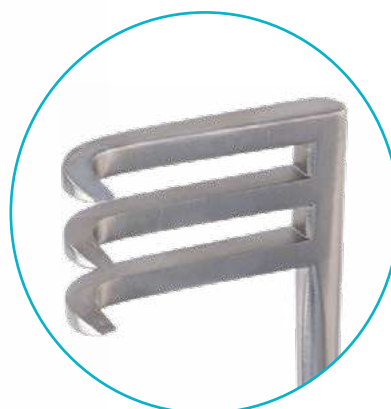

E032953

POINTU
SHARP

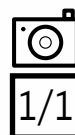

ECARTEUR AUTOSTATIQUE BECKMANN 10 x 140 MM MOUSSE

E032966 BECKMANN AUTOSTATIC RETRACTOR 10 X 140 MM BLUNT



LONGUEUR LENGTH	REFERENCE ITEMS	PROFONDEUR DEPTH
140 MM	E032966	10 MM
170 MM	E032967	12 MM
210 MM	E032968	15 MM
300 MM	E032969	20 MM
300 MM	E032970	30 MM
300 MM	E032971	50 MM

ECARTEUR AUTOSTATIQUE
BECKMANN CONE 170 MM MOUSSE

E032974 BECKMANN CONE AUTOSTATIC
RETRACTOR 170 MM BLUNT

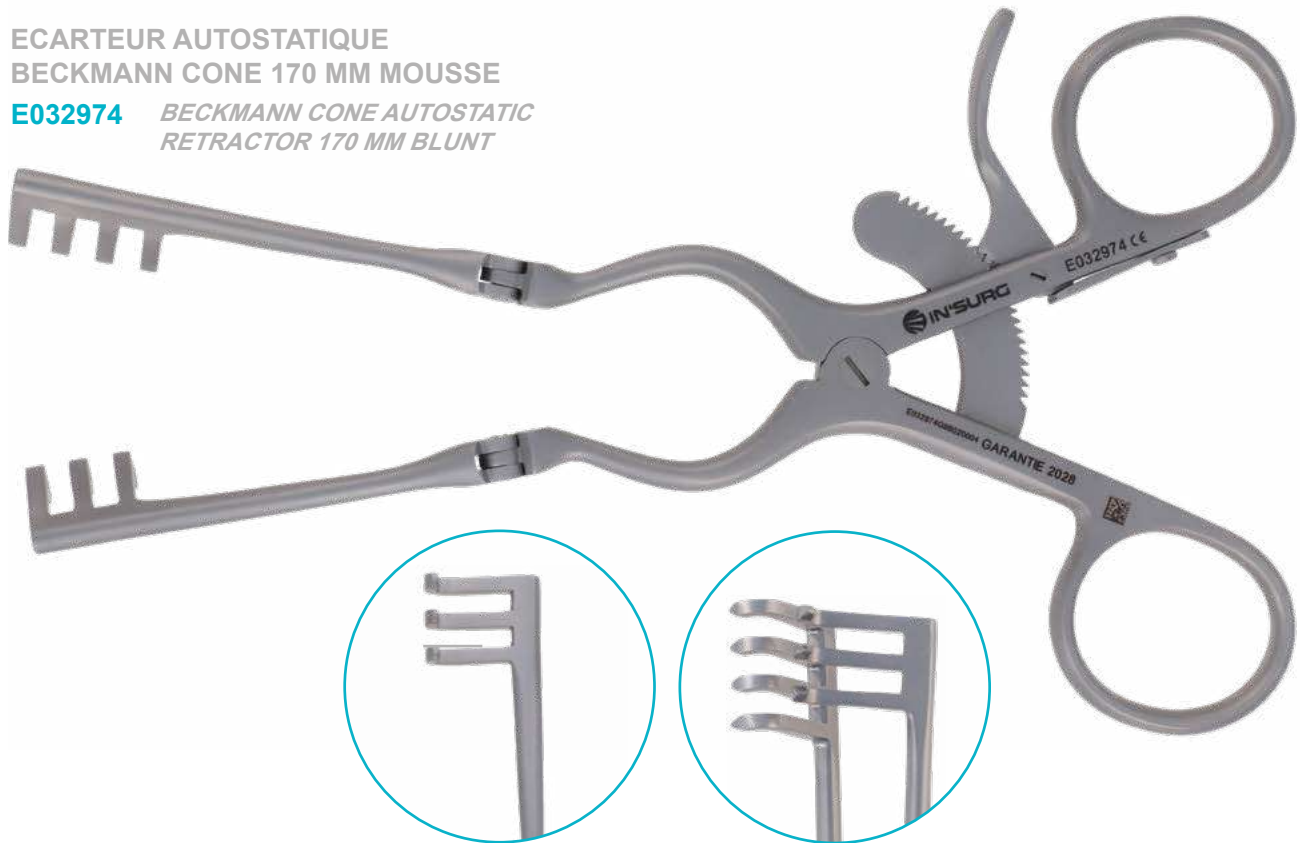

MOUSSE
BLUNT

POINTU
SHARP

LONGUEUR
LENGTH

3 X 4 GRIFFES
TEEHT

140 MM
170 MM
210 MM
240 MM

E032973

E032980

E032974

E032981

E032975

E032982

E032976

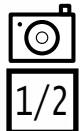

LONGUEUR
LENGTH

REFERENCE
ITEMS

PROFONDEUR
DEPTH

4 X 4 GRIFFES MOUSSES BLUNT THEET	330 MM	E032977	20 MM
	330 MM	E032978	30 MM
	330 MM	E032979	50 MM

AUTOSTATIC RETRACTOR

ECARTEUR AUTOSTATIQUE BECKMANN
EATON 47 X 330 MM MOUSSE

E032983 *BECKMANN EATON AUTOSTATIC
RETRACTOR 47 X 330 MM BLUNT*

ECARTEUR AUTOSTATIQUE BECKMANN
EATON 47 X 330 MM POINTU

E032984 *BECKMANN EATON AUTOSTATIC
RETRACTOR 47 X 330 MM SHARP*



ECARTEUR AUTOSTATIQUE BECKMANN
STILLE 35 X 330 MM MOUSSE

E032985 *BECKMANN STILLE AUTOSTATIC
RETRACTOR 35 X 330 MM BLUNT*

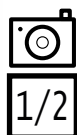

ECARTEUR AUTOSTATIQUE BECKMANN
STILLE 35 X 330 MM POINTU

E032986 *BECKMANN STILLE AUTOSTATIC
RETRACTOR 35 X 330 MM SHARP*

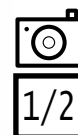

ECARTEUR AUTOSTATIQUE CHARNLEY 300 MM 2 x 2 GRIFFES HORIZONTALES

E032988 CHARNLEY AUTOSTATIC RETRACTOR 300 MM 2 X 2 HORIZONTAL TEETH

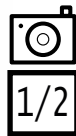

CADRE POUR ECARTEUR AUTOSTATIQUE
CHARNELY 237 X 310 MM CADRE SEUL

E033327 *FRAME FOR CHARNLEY AUTOSTATIC
RETRACTOR 237 X 310 MM FRAME ONLY*



CHAINE AVEC CROCHET POUR ECARTEUR
AUTOSTATIQUE CHARNLEY 540 MM L'UNITE

E033331 *CHAIN WITH HOOK FOR CHARNLEY
AUTOSTATIC RETRACTOR 540 MM THE UNIT*



VALVE POUR ECARTEUR AUTOSTATIQUE
CHARNELY 25 X 57 MM PROF 45 MM VALVE
SEULE

E033328 *VALVE FOR CHARNLEY AUTOSTATIC
RETRACTOR 25 X 57 MM DEPTH 45 MM
VALVE ONLY*



VALVE POUR ECARTEUR AUTOSTATIQUE
CHARNELY 26,5 X 190 MM PROF 45 MM VALVE
SEULE

E033329 *VALVE FOR CHARNLEY AUTOSTATIC
RETRACTOR 26,5 X 190 MM DEPTH 45 MM
VALVE ONLY*



POIDS POUR ECARTEUR AUTOSTATIQUE
CHARNELY 45 X 67 MM 830 GR POIDS SEUL

E033330 *WEIGH FOR CHARNLEY AUTOSTATIC
RETRACTOR 45 X 67 MM 830 G WEIGH ONLY*



ECARTEUR AUTOSTATIQUE CHARNLEY CADRE 310 MM - VALVES PROF 45 MM COMPLET
E032987 CHARNLEY AUTOSTATIC RETRACTOR COMPLETE FRAME 310 MM WITH VALVE 45 MM

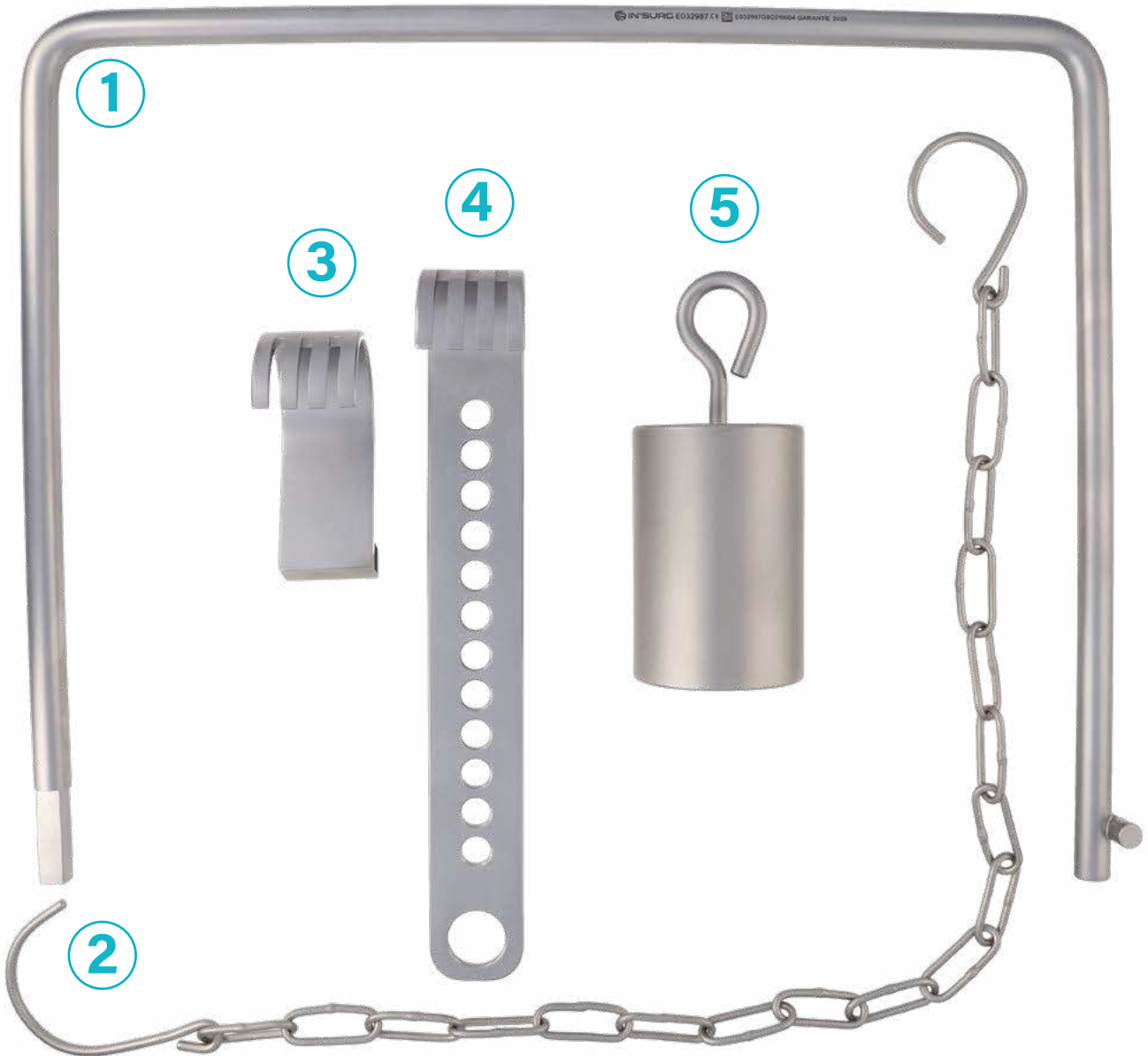

MOUSQUETON POUR CHAINE D'ECARTEUR DE TYPE CHARNLEY
E033341 CARABINER FOR CHAIN FOR RETRACTOR CHARNLEY TYPE

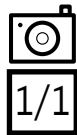

**ECARTEUR AUTOSTATIQUE CLOWARD
13 X 130 MM 1 X 1 GRIFFE MOUSSE**

E032989 CLOWARD AUTOSTATIC RETRACTOR
13 X 130 MM 1 X 1 TEETH BLUNT



**ECARTEUR AUTOSTATIQUE CLOWARD
140 MM 3 X 3 GRIFFES MOUSSES**

E032991 CLOWARD AUTOSTATIC RETRACTOR 140 MM
3 X 3 TEETH BLUNT



E032990
13 X 130 MM
3 X 3 GRIFFES MOUSSES
TEETH BLUNT

ECARTEUR AUTOSTATIQUE CONTUR 140 MM 3 X 4 GRIFFES POINTUES

E032992 *CONTUR AUTOSTATIC RETRACTOR 140 MM 3 X 4 TEETH SHARP*

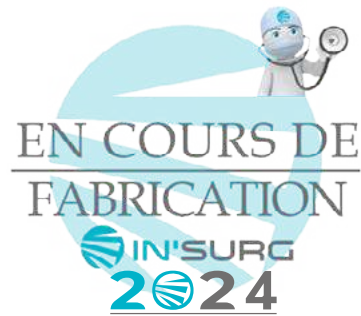

ECARTEUR AUTOSTATIQUE DAVIS
12 x 100 MM 3 x 3 GRIFFES MOUSSES

E032993 *DAVIS AUTOSTATIC RETRACTOR
12 X 100 MM 3 X 3 TEETH BLUNT*

ECARTEUR AUTOSTATIQUE DOS D'ANE
170 MM GRIFFES MOUSSES

E032996 *DOS D'ANE AUTOSTATIC RETRACTOR
170 MM TEETH BLUNT*



E032995
200 MM

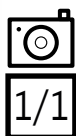

AUTOSTATIC RETRACTOR

ECARTEUR AUTOSTATIQUE FINSEN 70 MM
3 X 4 GRIFFES MOUSSES

E033001 *FINSEN AUTOSTATIC RETRACTOR
70 MM 3 X 4 TEETH BLUNT*

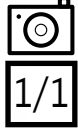
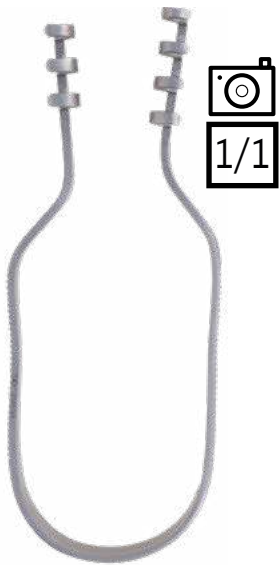

E033000
50 MM 2 X 3 GRIFFES MOUSSES
TEETH BLUNT

E033004
70 MM 2 X 3 GRIFFES MOUSSES REGLABLE
TEETH BLUNT ADJUSTABLE

ECARTEUR AUTOSTATIQUE FINSEN
50 MM 2 X 3 GRIFFES POINTUES

E033002 *FINSEN AUTOSTATIC RETRACTOR
50 MM 2 X 3 TEETH SHARP*

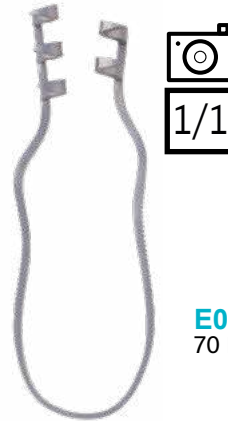

E033003
70 MM 3 X 4 GRIFFES POINTUES
TEETH SHARP

E033005
70 MM 3 X 4 GRIFFES POINTUES
REGLABLE
TEETH SHARP ADJUSTABLE

ECARTEUR AUTOSTATIQUE GELPI 90 MM

E033007 *GELPI AUTOSTATIC RETRACTOR 90 MM*

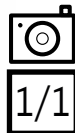

E033008
110 MM

E033009
130 MM

E033010
190 MM

ECARTEUR AUTOSTATIQUE FRIEDMANN 110 MM PR GOITRE
E033006 FRIEDMANN AUTOSTATIC RETRACTOR 110 MM GOITER

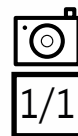

AUTOSTATIC RETRACTOR

ECARTEUR AUTOSTATIQUE GELPI SELETZ
150 MM COUDE

E033012 GELPI SELETZ AUTOSTATIC
RETRACTOR 150 MM ANGULATED



ECARTEUR AUTOSTATIQUE GELPI 190 MM
AVEC BUTEES

E033011 GELPI AUTOSTATIC RETRACTOR
190 MM WITH STOPPERS

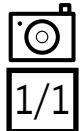

ECARTEUR AUTOSTATIQUE HEISS 100 MM 4 X 4 GRIFFES MOUSSES

E033014 HEISS AUTOSTATIC RETRACTOR 100 MM 4 X 4 TEETH BLUNT



E033014
100 MM - 4 X 4
GRIFFES MOUSSES
TEETH BLUNT

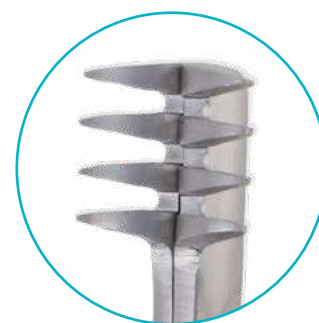

E033324
100 MM - 4 X 4
GRIFFES POINTUES
TEETH SHARP



AUTOSTATIC RETRACTOR

ECARTEUR AUTOSTATIQUE HENLEY 165 MM - 3 X 2 VALVES LAT.
25/50/75 MM - 3 VALVES MED. 16 X 19/25/32 MM COMPLET

E033015 *HENLEY AUTOSTATIC RETRACTOR 165 MM 3 X 2 VALVES LAT
25/ 50/ 75 MM - 3 VALVES MED 16 X 19/ 25/ 32 MM COMPLETE*

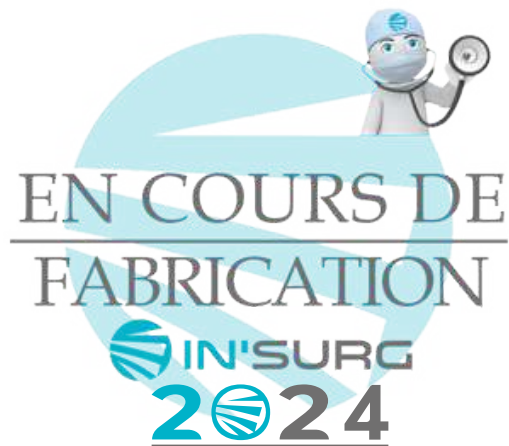

ECARTEUR AUTOSTATIQUE HENLEY SANS VALVE MEDIANE

E033018 HENLEY AUTOSTATIC RETRACTOR WITHOUT MEDIAN VALVE

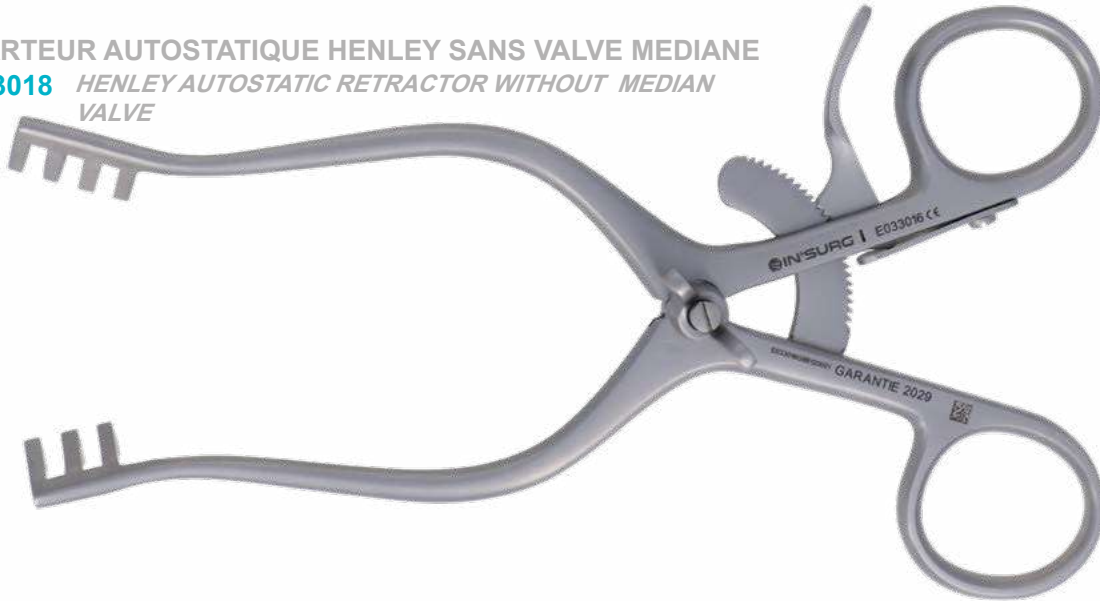

VALVE MEDIANE PR ECARTEUR AUTOSTATIQUE HENLEY 16 x 19 MM

E033019 VALVE MEDIAN FOR HENLEY AUTOSTATIC RETRACTOR 16 X 19 MM

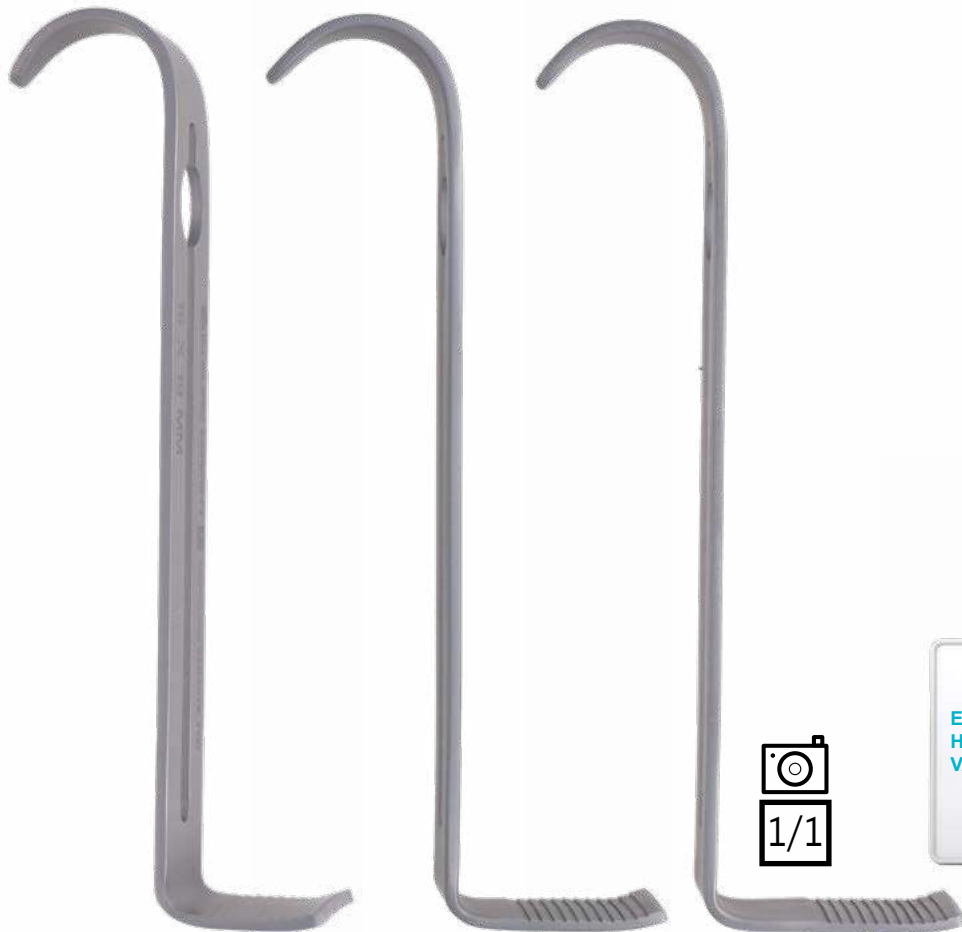

E033019
16 X 19 MM

E033020
16 X 25 MM

E033021
16 X 32 MM



E033017

ECARTEUR AUTOSTATIQUE HENLEY POINTUE AVEC 3 VALVES MEDIANES

HENLEY AUTOSTATIC RETRACTOR SHARP WITH 3 VALVES MEDIANES



E033016

ECARTEUR AUTOSTATIQUE HENLEY MOUSSE AVEC 3 VALVES MEDIANES

HENLEY AUTOSTATIC RETRACTOR BLUNT WITH 3 VALVES MEDIANES



AUTOSTATIC RETRACTOR

ECARTEUR AUTOSTATIQUE JANSEN 12 X 100 MM 3 X 3 GRIFFES
POINTUES

E033022 JANSEN AUTOSTATIC RETRACTOR 12 X 100 MM 3 X 3 SHARP
TEETH



E033024
12 X 100 MM 4 X 4
GRIFFES POINTUES
SHARP TEETH

E033023
20 X 100 MM 4 X 4
GRIFFES MOUSSES
BLUNT TEETH



ECARTEUR AUTOSTATIQUE JOLL A GOITRE

E033025 JOLL AUTOSTATIC RETRACTOR FOR GOITER

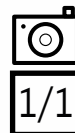

ECARTEUR AUTOSTATIQUE KOLBEL SANS VALVE 200 MM

E033326 KOLBEL AUTOSTATIC RETRACTOR WITHOUT VALVE 200 MM

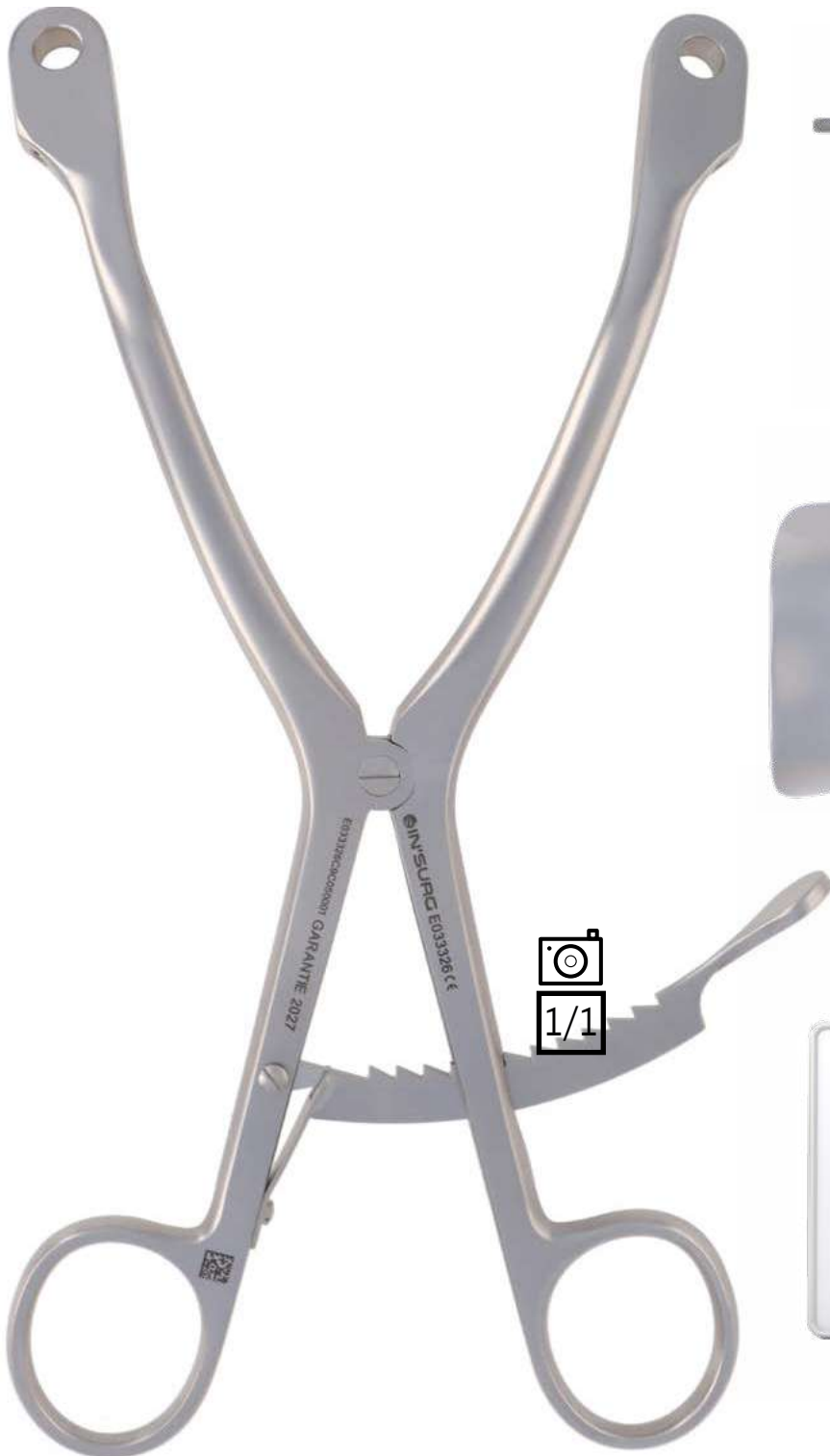

VALVES POUR ECARTEUR AUTOSTATIQUE KOLBEL 36 X 36 MM LA PAIRE

E033027 PAIR OF VALVES FOR KOLBEL AUTOSTATIC RETRACTOR 36 X 36 MM

E033028
53 X 36 MM

E033029
67 X 36 MM



E033026

ECARTEUR AUTOSTATIQUE KOLBEL 3 PAIRES DE VALVES 36/53/67 X 36 MM

KOLBEL AUTOSTATIC RETRACTOR WITH 3 PAIRS OF VALVES 36 / 53/ 67/ X 36 MM

ECARTEUR AUTO. MAC KEE 50 X 230 MM MOUSSE PR HANCHE

E033041 MAC KEE AUTOSTATIC RETRACTOR 50 X 230 MM BLUNT FOR HIP

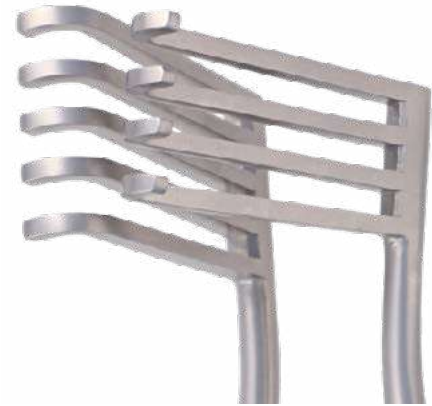

E033041
50 X 230 MM



DISPONIBLE EN PETITE CREMAILLERE
A PRECISER LORS DE LA COMMANDE
AVAILABLE IN SMALL RACK PLEASE SPECIFY
WHEN ORDERING



E033042
60 X 230 MM

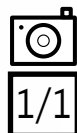

ECARTEUR AUTO. MAC KEE 4 GRIFFES A GAUCHE 35 MM / 5 GRIFFES A DROITE 50 MM
E033040 *MAC KEE AUTOSTATIC RETRACTOR 4 LEFT TEETH 35 MM / 5 RIGHT TEETH 50 MM*

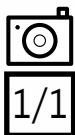

E033039
4 GRIFFES A DROITE 35 MM
5 GRIFFES A GAUCHE 50 MM

*4 RIGHT TEETH 35 MM
5 LEFT TEETH 50 MM*

ECARTEUR AUTO. MERLE D'AUBIGNE VALVES PIVOTANTES 45 X 33 MM

E033044 MERLE D'AUBIGNE AUTOSTATIC RETRACTOR PIVOTED VALVES 45 X 33 MM



ECARTEUR AUTO. MISKIMON 32 X 220 MM 7 X 7 GRIFFES MOUSSES

E033045 MISKIMON AUTOSTATIC RETRACTOR 32 X 220 MM 7 X 7 TEETH BLUNT



E033046
GRIFFES POINTUES
TEETH SHARP

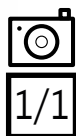

ECARTEUR AUTO. ALAN PARKS 135 MM COMPLET

E033049 ALAN PARKS AUTOSTATIC RETRACTOR 135 MM COMPLETE



ECARTEUR AUTO. PERKINS 130 MM
PALETTE A DROITE

E033050 PERKINS AUTOSTATIC RETRACTOR
130 MM RIGHT-HAND PALLET



ECARTEUR AUTO. PERKINS 130 MM
PALETTE A GAUCHE

E033051 PERKINS AUTOSTATIC RETRACTOR
130 MM LEFT-HAND PALLET



ECARTEUR AUTO. ORTEIL
80 MM A VIS

E033048 ORTEIL AUTOSTATIC RETRACTOR
WITH SCREW 80 MM

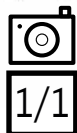
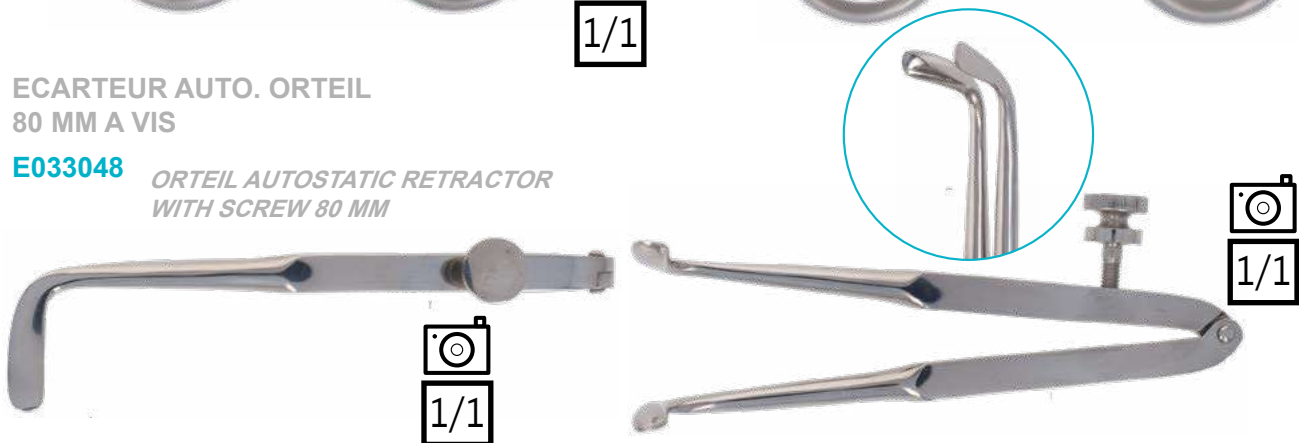

ECARTEUR AUTOSTATIQUE BADGLEY
45 X 50 X 108 MM OUV MAX 165 MM

E033057 BAGDLEY AUTOSTATIC RETRACTOR
45 X 50 X 108 MM OPEN MAX 165 MM

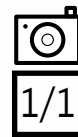

**ECARTEUR AUTOSTATIQUE CHANDLER
AVEC 3 PAIRES DE VALVES 45/65/80 MM**

E033174 CHANDLER AUTOSTATIC
RETRACTOR WITH 3 PAIRS
VALVES 45/65/80 MM

**ECARTEUR AUTOSTATIQUE INGE
50 x 250 MM**

E033208 INGE AUTOSTATIC RETRACTOR
50 X 250 MM

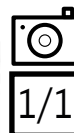

ECARTEUR AUTOSTATIQUE INGE MEARY 38 x 160 MM

E033209 INGE MEARY AUTOSTATIC RETRACTOR 38 X 160 MM



ECARTEUR AUTOSTATIQUE INGE MEARY 40 x 260 MM

E033210 INGE MEARY AUTOSTATIC RETRACTOR 40 X 260 MM



ECARTEUR AUTOSTATIQUE
KNIGHTON 32 x 180 MM GRIFFES A
DROITE POINTUES

E033213 KNIGHTON AUTOSTATIC RETRACTOR
32 X 180 MM RIGHT TEETH SHARP



E033211
32 X 180 MM
GRIFFES A DROITE
MOUSSE
RIGHT TEETH BLUNT

ECARTEUR AUTOSTATIQUE
KNIGHTON 32 x 180 MM GRIFFES A
GAUCHE POINTUES

E033214 KNIGHTON AUTOSTATIC RETRACTOR
32 X 180 MM LEFT TEETH SHARP



E033212
32 X 180 MM
GRIFFES A GAUCHE
MOUSSE
LEFT TEETH BLUNT

ECARTEUR AUTOSTATIQUE LILLOIS AVEC 6 PAIRES DE VALVES INOX POIDS 826 GR

E033215

LILLOIS AUTOSTATIC RETRACTOR WITH 6 PAIRS OF VALVES WEIGHT 826 GR STAINLESS STEEL



ADAPTATEUR POUR RACINE POUR ECARTEUR
AUTOSATIQUE RACHIDIEN LILLOIS INOX

E033216

ROOT ADJUSTEMENT FOR LILLOIS SPINAL
AUTOSTATIC RETRACTOR STAINLESS STEEL



ECARTEUR AUTOSTATIQUE MEYERDING 19 x 60 x 200 MM

E033234 MEYERDING AUTOSTATIC RETRACTOR 19 X 60 X 200 MM



E033235
25 X 32 X 200 MM

E033236
25 X 54 X 200 MM

E033237
25 X 60 X 200 MM

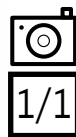

ECARTEUR AUTOSTATIQUE Mc CULLOCH CADRE FIXE OUVERTURE MAX 85 MM SEUL

E033332 *MC CULLOCH AUTOSTATIC RETRACTOR OPENING MAX 85 MM FIXED FRAME ONLY*



ECARTEUR AUTOSTATIQUE Mc CULLOCH CADRE PLIANT
SEUL OUVERTURE MAX 85 MM

E033343 *MC CULLOCH AUTOSTATIC RETRACTOR OPENING MAX 85 MM
FOLDING FRAME ONLY*



VALVE MULTIGRIFFES POUR ECARTEUR AUTOSTATIQUE
Mc CULLOCH 27 X 30 MM 6 GRIFFES LA PAIRE

E033333 VALVE FOR Mc CULLOCH AUTOSTATIC RETRACTOR
27 X 30 MM 6 TEETHS THE PAIR



E033333
27 X 30 MM



E033334
27 X 40 MM



E033335
27 X 50 MM



E033336
27 X 60 MM



VALVE CROCHET POUR ECARTEUR AUTOSTATIQUE
Mc CULLOCH 1,8 X 20 MM L'UNITE

E033337 HOOK VALVE FOR Mc CULLOCH AUTOSTATIC
RETRACTOR 1,8 X 20 MM THE UNIT



E033337
1.8 X 20 MM

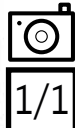

E033338
1.8 X 30 MM



E033339
1.8 X 40 MM



E033340
1.8 X 50 MM



ECARTEUR AUTOSTATIQUE

AUTOSTATIC RETRACTOR

ECARTEUR AUTOSTATIQUE
MARCKAM MEYERDING 25 x 180 MM
VALVE A DROITE

E033228 MARCKAM MEYERDING AUTOSTATIC
RETRACTOR 25 X 180 MM RIGHT VALVE

ECARTEUR AUTOSTATIQUE
MARCKAM MEYERDING 25 x 180 MM
VALVE A GAUCHE

E033230 MARCKAM MEYERDING AUTOSTATIC
RETRACTOR 25 X 180 MM LEFT VALVE



E033229
44 X 180 MM
VALVE A DROITE
RIGHT VALVE

E033231
44 X 180 MM
VALVE A GAUCHE
LEFT VALVE

ECARTEUR AUTO.RACHIDIEN 115 MM
LONGITUDINAL RADIOTRANSSPARENT
CERVICAL

E033250 *SPINAL AUTOSTATIC RETRACTOR 115 MM
LONGITUDINAL RADIOLUCENT CERVICAL*

ECARTEUR AUTO.RACHIDIEN 170 MM
LONGITUDINAL RADIOTRANSSPARENT
CERVICAL

E033251 *SPINAL AUTOSTATIC RETRACTOR 170 MM
LONGITUDINAL RADIOLUCENT CERVICAL*

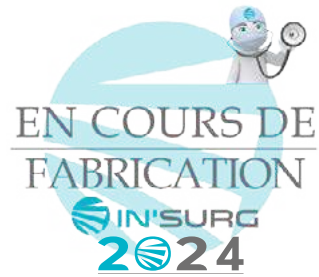
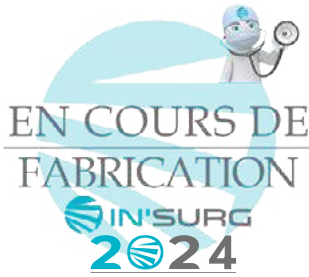

VALVE RADIOTRANSARENTE PR ECARTEUR AUTOSTATIQUE
RADIOLUCENT VALVE FOR AUTOSTATIC RETRACTOR



4 GRIFFES
4 TEETH



MOUSSE
BLUNT



MULTIGRIFFES
MULTITEETH

PROFONDEUR
DEPTH

40 MM
50 MM
60 MM

E033238
E033239
E033240

E033241
E033242
E033243

E033246
E033247
E033248

ECARTEUR AUTOSTATIQUE RIGBY 16 x 70 x 190 MM

E033298 RIGNY AUTOSTATIC RETRACTOR 16 X 70 X 190 MM



**ECARTEUR AUTOSTATIQUE WILLIAMS
10 x 50 x 170 MM VALVE A DROITE**

E033289 *WILLIAMS AUTOSTATIC RETRACTOR
10 X 50 X 170 MM VALVE AT RIGHT*



E033291
10 X 70 X 170 MM VALVE A DROITE
VALVE ON THE RIGHT

E033293
20 X 50 X 170 MM VALVE A DROITE
VALVE ON THE RIGHT

E033296
20 X 70 X 170 MM VALVE A DROITE
VALVE ON THE RIGHT

**ECARTEUR AUTOSTATIQUE WILLIAMS
10 x 50 x 170 MM VALVE A GAUCHE**

E033290 *WILLIAMS AUTOSTATIC RETRACTOR
10 X 50 X 170 MM VALVE AT LEFT*

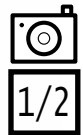

E033292
10 X 70 X 150 MM VALVE A GAUCHE
VALVE ON THE LEFT

E033294
20 X 50 X 170 MM VALVE A GAUCHE
VALVE ON THE LEFT

E033297
20 X 70 X 170 MM VALVE A GAUCHE
VALVE ON THE LEFT

BRAS PR ECARTEUR AUTOSTATIQUE UNIVERSEL 470 x 170 MM EN L

E033299 ARMS FOR UNIVERSAL AUTOSTATIC RETRACTOR 470 X 170 MM IN L



ETAU DE FIXATION POUR ECARTEUR UNIVERSEL

E033303 *FIXING SYSTEM FOR UNIVERSAL AUTOSTATIC RETRACTOR*



FIXE ENDOSCOPE POUR ECARTEUR UNIVERSEL PR ENDOSCOPE DE 8 A 10 MM

E033304 *ENDOSCOPE FIXING FOR UNIVERSAL AUTOSTATIC RETRACTOR FOR ENDOSCOPE 8 AT10 MM*

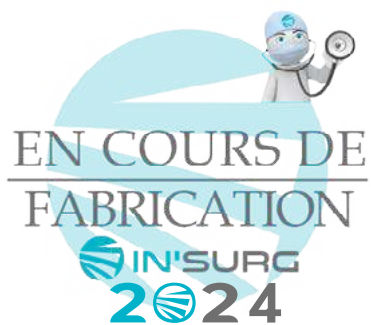

BRAS PR ECARTEUR AUTOSTATIQUE UNIVERSEL 400 x 400 x 170 MM EN U

E033301 ARMS FOR UNIVERSAL AUTOSTATIC RETRACTOR 400 X 400 X 170 MM IN U

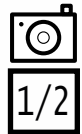

ETAU DE FIXATION POUR
ECARTEUR UNIVERSEL

E033303

FIXING SYSTEM FOR UNIVERSAL
AUTOSTATIC RETRACTOR

FIXE ENDOSCOPE POUR ECARTEUR
UNIVERSEL PR ENDOSCOPE
DE 8 A 10 MM

E033304 ENDOSCOPE FIXING FOR UNIVERSAL
AUTOSTATIC RETRACTOR FOR
ENDOSCOPE 8 AT10 MM

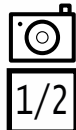
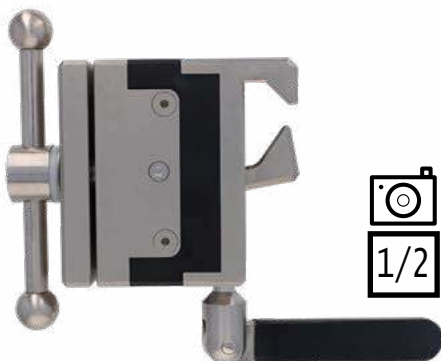

EN COURS DE
FABRICATION



IN'SURG
2024

ECARTEUR AUTOSTATIQUE WEITLANER 130 MM 3 x 4 GRIFFES MOUSSES

E033307 WEITLANER AUTOSTATIC RETRACTOR 130 MM 3 X 4 TEETH BLUNT



GRIFFES MOUSSES
TEETH BLUNT

LONGUEUR LENGTH	2 X 3 GRIFFES 2 X 3 TEETH	3 X 4 GRIFFES 3 X 4 TEETH	5 X 6 GRIFFES 5 X 6 TEETH
	105 MM	E033306	
130 MM		E033307	E033311
165 MM	E033308		
200 MM		E033309	
250 MM		E033310	E033312

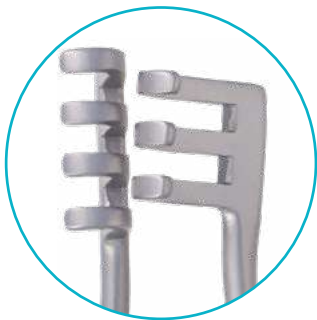

GRIFFES POINTUES
TEETH SHARP

LONGUEUR LENGTH	2 X 3 GRIFFES 2 X 3 TEETH	3 X 4 GRIFFES 3 X 4 TEETH	5 X 6 GRIFFES 5 X 6 TEETH
	105 MM	E033313	
130 MM		E033314	E033318
165 MM		E033315	
200 MM		E033316	
250 MM		E033317	E033319



ECARTEUR AUTOSTATIQUE WEITLANER WULLSTEIN 130 MM MOUSSE

E033321 WEITLANER WULLSTEIN AUTOSTATIC RETRACTOR 130 MM BLUNT



E033321
MOUSSE
BLUNT



E033322
POINTU
SHARP

ECARTEUR AUTOSTATIQUE WEITLANER WULLSTEIN
100 MM 3 X 3 GRIFFES MOUSSE

E033320 WEITLANER WULLSTEIN AUTOSTATIC
RETRACTOR 100 MM 3 X 3 TEETHS BLUNT

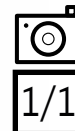
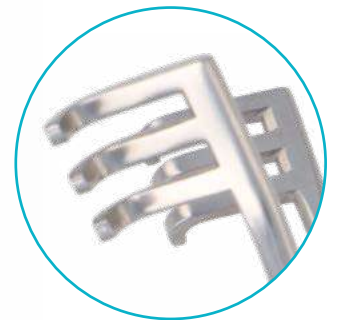
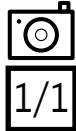

ECARTEUR AUTO. MASTOIDIEN VACHER OUVERTURE MAX 80 MM

E033305 VACHER MASTOID AUTOSTATIC RETRACTOR OPENING MAX 80 MM

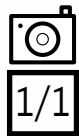



DISTRACTEUR A ANGULATION REGLABLE
CASPAR ECARTEMENT A DROITE

E032946 CASPAR DISTRACTOR WITH ADJUSTABLE ANGULATION, RIGHT SPACING

TOURNEVIS CASPAR POUR VIS E032945
E032949

CASPAR TOURNEVIS FOR SCREWS E032945



E032947
ECARTEMENT A GAUCHE
LEFT OPENING

2 VIS PR DISTRACTEUR CASPAR A
ANGULATION REGLABLE 14 MM

E032945 2 SCREWS FOR CASPAR DISTRACTOR
WITH ADJUSTABLE ANGULATION 14 MM

LEVIER DE REGLAGE PR DISTRACTEUR
CASPAR A ANGULATION REGLABLE

E032948 ADJUSTER LEVER FOR CASPAR
DISTRACTOR WITH ADJUSTABLE
ANGULATION

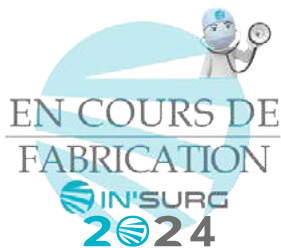

ECARTEUR AUTO. CASPAR ECARTEMENT 115 MM ARTICULE

E033061 CASPAR AUTOSTATIC RETRACTOR OPENING 115 MM ARTICULATED



ECARTEUR AUTO. CASPAR ECARTEMENT 165 MM ARTICULE

E033063 CASPAR AUTOSTATIC RETRACTOR OPENING 165 MM ARTICULATED



ECARTEUR AUTO. CASPAR ECARTEMENT 120 MM ARTICULE

E033062 CASPAR AUTOSTATIC RETRACTOR OPENING 120 MM ARTICULATED

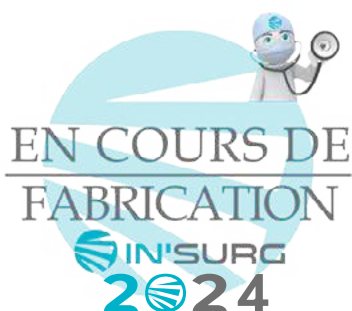

VALVES PAGE 630, 631, 632

EJECTEUR DE VALVE PAGE 629

PINCE D'EJECTION DE VALVE PR ECARTEUR AUTO. CASPAR

E033065 DISCHARGE FORCEPS FOR CASPAR VALVE RETRACTOR



1



2



3



VALVE PR ECARTEUR AUTO. CASPAR 40 x 23 MM MULTIGRIFFES MOUSSES

E033066 VALVE FOR CASPAR AUTOSTATIC RETRACTOR 40 X 23 MM MULTITEETHS BLUNT

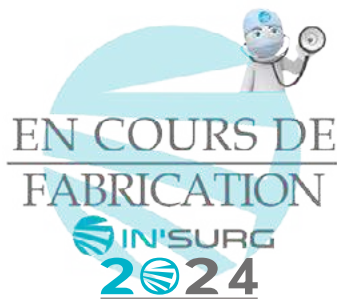

VALVES LATERALES

LATERALS VALVES

	LARGEUR WIDTH
	23 MM
PROFONDEUR DEPTH	
40 MM	E033066
45 MM	E033067
50 MM	E033068
55 MM	E033069
60 MM	E033070

VALVE PR ECARTEUR AUTO. CASPAR 40 x 23 MM 5 GRIFFES MOUSSES

E033081 VALVE FOR CASPAR AUTOSTATIC RETRACTOR 40 X 23 MM 5 BLUNT TEETH

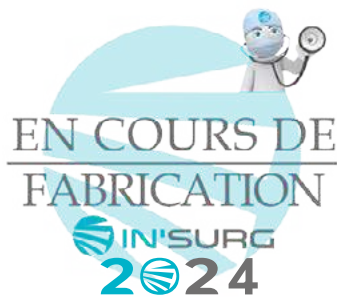

VALVES MEDIANES

MEDIANS VALVES

	LARGEUR WIDTH
	23 MM
PROFONDEUR DEPTH	
40 MM	E033081
45 MM	E033082
50 MM	E033083
55 MM	E033084
60 MM	E033085



VALVE PR ECARTEUR AUTO. CASPAR 60 x 24 MM
FENETREE MULTIGRIFFES MOUSSES TITAN ULTRA

E033078 TITAN ULTRA VALVE FOR CASPAR AUTOSTATIC
RETRACTOR 60 X 24 MM FENESTRATED
MULTITEETHS BLUNT



VALVES LATERALES

LATERAL VALVES

PROFONDEUR
DEPTH

LARGEUR
WIDTH
24 MM

25 MM	E033071
30 MM	E033072
35 MM	E033073
40 MM	E033074
45 MM	E033075
50 MM	E033076
55 MM	E033077
60 MM	E033078
65 MM	E033079
70 MM	E033080

VALVES MEDIANES

MEDIAN VALVES

LARGEUR
WIDTH
24 MM

PROFONDEUR
DEPTH

25 MM	E033086
30 MM	E033087
35 MM	E033088
40 MM	E033089
45 MM	E033090
50 MM	E033091
55 MM	E033092
60 MM	E033093
65 MM	E033094
70 MM	E033095



VALVE PR ECARTEUR AUTO. CASPAR 25 x 24 MM
FENETREE 5 GRIFFES MOUSSES TITAN ULTRA

E033086 TITAN ULTRA VALVE FOR CASPAR AUTOSTATIC
RETRACTOR 25 X 24 MM FENESTRATED 5 TEETH
BLUNT

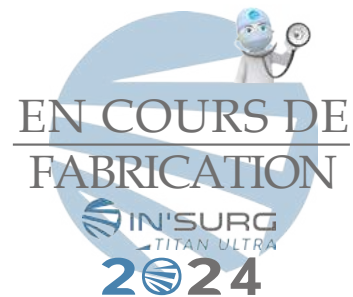

VALVE PR ECARTEUR AUTOSTATIQUE CASPAR
30 x 24 MM MULTIGRIFFES MOUSSES TITAN ULTRA

E033101 TITAN ULTRA VALVE FOR CASPAR AUTOSTATIC
RETRACTOR 30 X 24 MM MULTITEETHS BLUNT



VALVES LATERALES

LATERAL VALVES

PROFONDEUR DEPTH	LARGEUR WIDTH 24 MM
30 MM	E033101
50 MM	E033103
55 MM	E033104
60 MM	E033105

VALVE PR ECARTEUR AUTOSTATIQUE CASPAR
45 x 24 MM MOUSSES TITAN ULTRA

E033102 TITAN ULTRA VALVE FOR CASPAR
AUTOSTATIC RETRACTOR 45 X 24 MM
BLUNT



VALVES LATERALES

LATERAL VALVES

PROFONDEUR DEPTH	LARGEUR WIDTH 24 MM
65 MM	E033106
75 MM	E033107

VALVE PR ECARTEUR AUTOSTATIQUE
CASPAR 45 x 23 MM MOUSSE

E033096 VALVE FOR CASPAR AUTOSTATIC
RETRACTOR 45 X 23 MM BLUNT

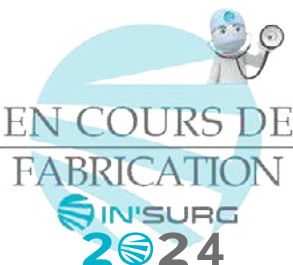

VALVES LATERALES

LATERAL VALVES

PROFONDEUR DEPTH	LARGEUR WIDTH 23 MM
45 MM	E033096
50 MM	E033097
55 MM	E033098
60 MM	E033099
65 MM	E033100

CASPAR AUTOSTATIC RETRACTOR

TOURNEVIS POUR DISTRACTEUR
AUTO. RACHIDIEN CASPAR

E033121 *SCREWDRIVER CASPAR SPINAL
AUTOSTATIC DISTRACTOR*

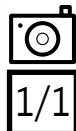

2 VIS PR DISTRACTEUR SIMPLE CASPAR
12 MM POUR TOURNEVIS E033121

E033323 *2 SCREWS FOR CASPAR SINGLE
DISTRACTOR 12 MM FOR SCREWDRIVER
E033121*



2 VIS PR DISTRACTEUR SIMPLE CASPAR
14 MM POUR TOURNEVIS E033121

E033109 *2 SCREWS FOR CASPAR SINGLE
DISTRACTOR 14 MM FOR
SCREWDRIVER E033121*



2 VIS PR DISTRACTEUR SIMPLE CASPAR
16 MM POUR TOURNEVIS E033121

E033110 *2 SCREWS FOR CASPAR SINGLE
DISTRACTOR 16 MM FOR
SCREWDRIVER E033121*

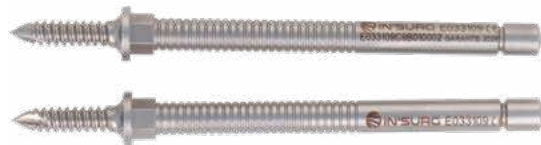

2 VIS PR DISTRACTEUR SIMPLE CASPAR
18 MM POUR TOURNEVIS E033121

E033111 *2 SCREWS FOR CASPAR SINGLE
DISTRACTOR 18 MM FOR
SCREWDRIVER E033121*



DISSECTEUR PR DISTRACTEUR
SIMPLE CASPAR 205 MM

E033112 *DISSORTOR FOR CASPAR
SINGLE DISTRACTOR 205 MM*

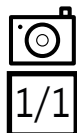

PORTE GREFFON POUR DISTRACTEUR AUTO.
RACHIDIEN CASPAR

E033120 *GRAFT HANGER FOR CASPAR SPINAL
AUTOSTATIC DISTRACTOR*

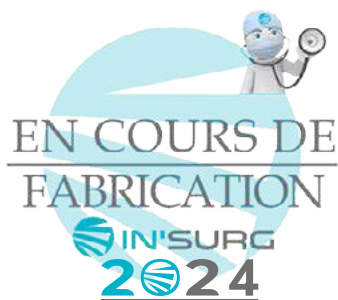

DISTRACTEUR AUTO. RACHIDIEN CASPAR ECARTEMENT A DROITE

E033113 CASPAR SPINAL AUTOSTATIC DISTRACTOR RIGHT OPENING



E033114

VERSION LONGUE ECARTEMENT A DROITE

LONGER VERSION RIGHT OPENING

DISTRACTEUR AUTO. RACHIDIEN CASPAR ECARTEMENT A GAUCHE

E033115 CASPAR SPINAL AUTOSTATIC DISTRACTOR LEFT OPENING



E033116

VERSION LONGUE ECARTEMENT A GAUCHE

LONGER VERSION LEFT OPENING

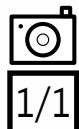

GUIDE POUR DISTRACTEUR AUTO.
RACHIDIEN CASPAR E033113

E033117 *GUIDE FOR CASPAR SPINAL
AUTOSTATIC DISTRACTOR
E033113*

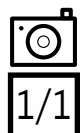

GUIDE POUR DISTRACTEUR AUTO.
RACHIDIEN CASPAR E033115

E033118 *GUIDE FOR CASPAR SPINAL AUTOSTATIC
DISTRACTOR E033115*





ECARTEUR AUTO.RACHIDIEN CASPAR LOMBAIRE L'UNITE

E033122 CASPAR SPINAL LUMBAR AUTOSTATIC DISTRACTOR UNIT



SPECULUM NEURO PR ECARTEUR AUTO. CASPAR 40 MM LOMBAIRE

E033123 *SPECULUM NEURO FOR CASPAR SPINAL LUMBAR AUTOSTATIC RETRACTOR 40 MM*



- E033124**
45 MM
- E033125**
50 MM
- E033126**
55 MM
- E033127**
60 MM
- E033128**
65 MM
- E033129**
75 MM
- E033130**
85 MM



VALVE PR ECARTEUR AUTOSTATIQUE CASPAR 35 MM

E033131 *VALVE FOR CASPAR AUTOSTATIC RETRACTOR 35 MM*

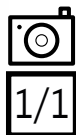

- E033132**
40 MM
- E033133**
45 MM
- E033134**
50 MM
- E033135**
55 MM
- E033136**
60 MM
- E033137**
65 MM
- E033138**
75 MM
- E033139**
85 MM

ECARTEUR AUTOSTATIQUE CLOWARD

CLOWARD RETRACTOR

ECARTEUR AUTOSTATIQUE CLOWARD 15 x 160 MM

E033198 *CLOWARD AUTOSTATIC RETRACTOR 15 X 160 MM*

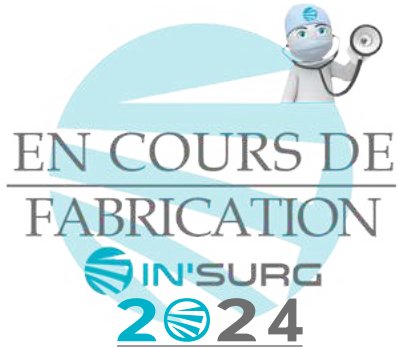

ECARTEUR AUTOSTATIQUE CLOWARD 20 x 150 MM

E033199 *CLOWARD AUTOSTATIC RETRACTOR 20 X 150 MM*



ECARTEUR AUTOSTATIQUE CLOWARD 20 MM
E033200 CLOWARD AUTOSTATIC RETRACTOR 20 MM



ECARTEUR AUTOSTATIQUE CLOWARD 28 X 165 MM
E033201 CLOWARD AUTOSTATIC RETRACTOR 28 X 165 MM

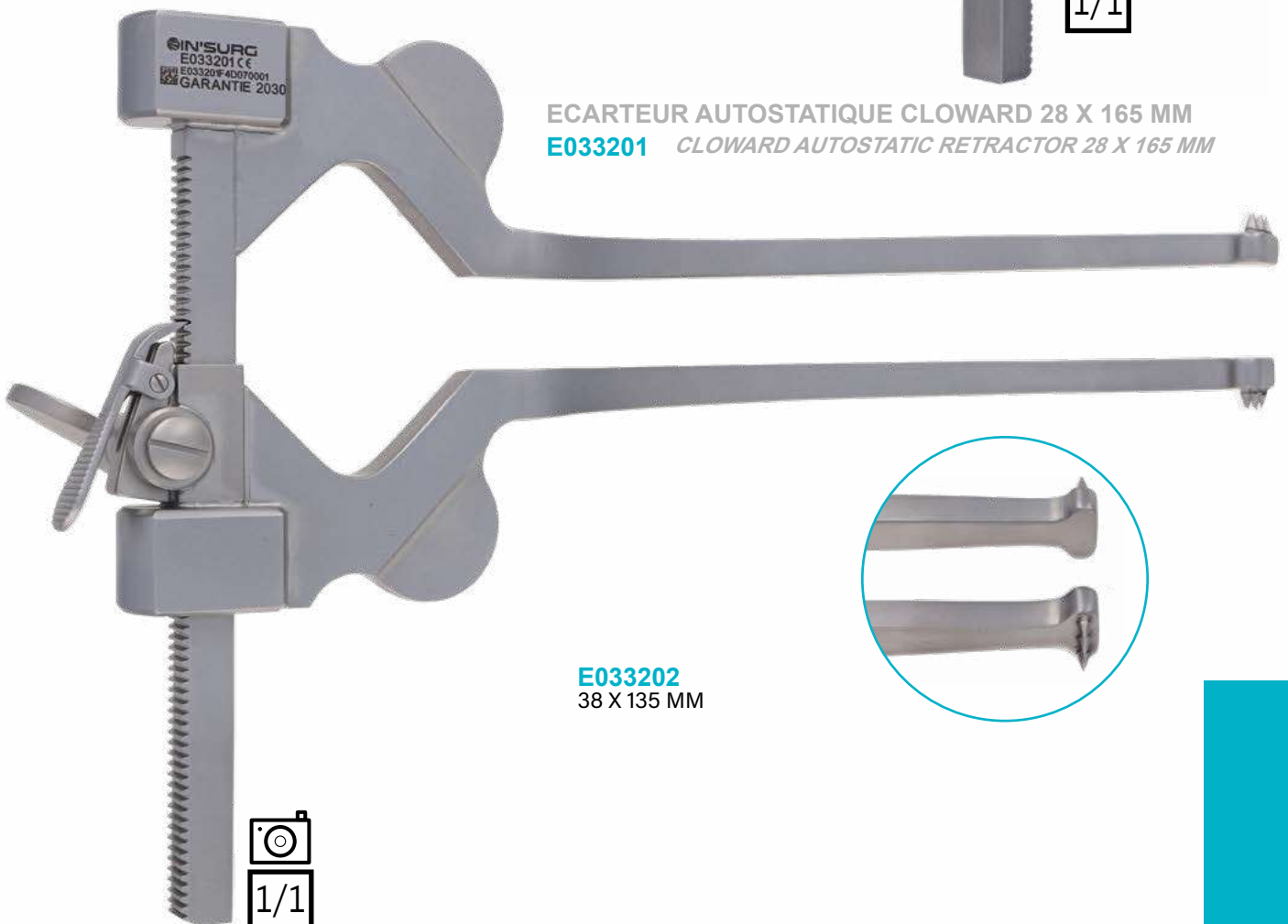

E033202
38 X 135 MM

ECARTEUR AUTOSTATIQUE CLOWARD

CLOWARD AUTOSTATIC RETRACTOR

ECARTEUR AUTOSTATIQUE CLOWARD 150 MM SANS VALVE
E033203 *CLOWARD AUTOSTATIC RETRACTOR 150 MM WITHOUT VALVE*



VALVES PAGE 644

E033205 ECARTEUR AUTOSTATIQUE CLOWARD 223 MM SANS VALVE DOUBLE ARTICULATION
CLOWARD AUTOSTATIC RETRACTOR 223 MM DOUBLE ARTICULATED WITHOUT VALVE



E033204 ECARTEUR AUTOSTATIQUE CLOWARD 200 MM
SANS VALVE ARTICULE
*CLOWARD AUTOSTATIC RETRACTOR 200 MM
WITHOUT ARTICULATED VALVE*

EN COURS DE
FABRICATION
IN'SURG
2024



ECARTEUR AUTOSTATIQUE
CLOWARD

CLOWARD AUTOSTATIC RETRACTOR

ECARTEUR AUTOSTATIQUE CLOWARD 250 MM SANS VALVE ARTICULE

E033207 CLOWARD AUTOSTATIC RETRACTOR 250 MM
ARTICULATED WITHOUT VALVE

VALVE PR ECARTEUR AUTOSTATIQUE CLOWARD

VALVE FOR CLOWARD AUTOSTATIC RETRACTOR



**PROFONDEUR
DEPTH**

**SANS GRIFFE
WITHOUT TEETH**

**A GRIFFES
WITH TEETH**

**MULTIGRIFFES
MULTITEETH**

25 MM	E033184		
30 MM	E033185		
35 MM	E033186	E033192	
40 MM	E033187	E033193	
45 MM	E033188	E033194	
50 MM	E033189	E033195	E033182
55 MM	E033190	E033196	
60 MM	E033191	E033197	
64 MM			E033183

ECARTEUR AUTOSTATIQUE SCOVILLE HAVERFIELD

SCOVILLE HAVERFIELD AUTOSTATIC RETRACTOR

ECARTEUR AUTOSTATIQUE SCOVILLE HAVERFIELD 150 MM L'UNITE
E033281 *SCOVILLE HAVERFIELD AUTOSTATIC RETRACTOR 150 MM UNIT*



VALVE HIBBS PR ECARTEUR AUTOSTATIQUE SCOVILLE HAVERFIELD
25 X 64 MM MULTIGRIFFES POINTUES

E033256 *HIBBS VALVE FOR SCOVILLE HAVERFIELD AUTOSTATIC RETRACTOR
25 X 64 MM MULTITEETH SHARP*



E033253
25 X 50 MM

E033265
38 X 64 MM

E033271
50 X 75 MM

E033259
25 X 75 MM

E033266
38 X 75 MM

E033273
50 X 100 MM

E033262
25 X 88 MM

E033267
38 X 88 MM

E033276
64 X 75 MM

E033263
25 X 100 MM

E033269
50 X 50 MM

VALVE PR ECARTEUR AUTOSTATIQUE
SCOVILLE HAVERFIELD 25 x 57 MM
MULTIGRIFFES MOUSSES

E033254 VALVE FOR SCOVILLE HAVERFIELD
AUTOSTATIC RETRACTOR 25 X 57 MM
MULTITEETH BLUNT



E033255
25 X 64 MM

E033258
25 X 75 MM

E033261
25 X 88 MM

E033270
50 X 64 MM

VALVE MEYERDING PR ECARTEUR AUTOSTATIQUE
SCOVILLE HAVERFIELD 25 x 70 MM MOUSSE

E033257 MEYERDING VALVE FOR SCOVILLE
HAVERFIELD AUTOSTATIC
RETRACTOR 25 X 70 MM BLUNT



E033260
25 X 83 MM

E033272
50 X 88 MM

VALVE PR ECARTEUR AUTOSTATIQUE
SCOVILLE HAVERFIELD 50 MM CROCHET
MOUSSE AVEC BUTEE

E033277 VALVE FOR SCOVILLE HAVERFIELD
AUTOSTATIC RETRACTOR 50 MM
BLUNT HOOK WITH ENDSTOP

VALVE TAYLOR PR ECARTEUR AUTOSTATIQUE
SCOVILLE HAVERFIELD 38 x 44 MM
3 GRIFFES POINTUES

E033264 TAYLOR VALVE FOR SCOVILLE HAVERFIELD
AUTOSTATIC RETRACTOR 38 X 44 MM
3 TEETH SHARP

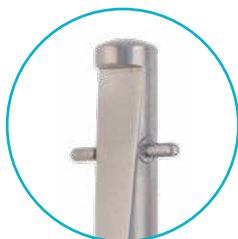

E033278
75 MM
AVEC BUTEE
WITH ENDSTOP



E033279
50 MM
SANS BUTEE
WITHOUT ENDSTOP

E033280
75 MM
SANS BUTEE
WITHOUT ENDSTOP



4 GRIFFES
4 TEETHS

E033268
50 X 48 MM

E033274
57 X 80 MM

E033275
64 X 64 MM

ECARTEUR DOUBLE

DOUBLE RETRACTOR

ECARTEUR DOUBLE CLAQUE
100 MM MOUSSE

E043323 *CLAQUE DOUBLE
RETRACTOR 100 MM
BLUNT*

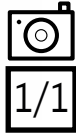

ECARTEUR DOUBLE COPE
6 x 11 x 160 MM

E043324 *COPE DOUBLE RETRACTOR
6 X 11 X 180 MM*

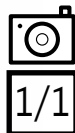

ECARTEUR DOUBLE COTTLE
NIEVERT 200 MM

E043325 *COTTLE NIEVERT DOUBLE
RETRACTOR 200 MM*

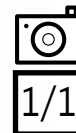

ECARTEUR DOUBLE CRILE 4 x 12 / 6 x 20 x 110 MM

E043326 CRILE DOUBLE RETRACTOR 4 X 12 / 6 X 20 X 110 MM



ECARTEUR DOUBLE DAUTREY GRAND MODELE PR O.R.L

E043327 DAUTREY DOUBLE RETRACTOR LARGE MODEL FOR ENT

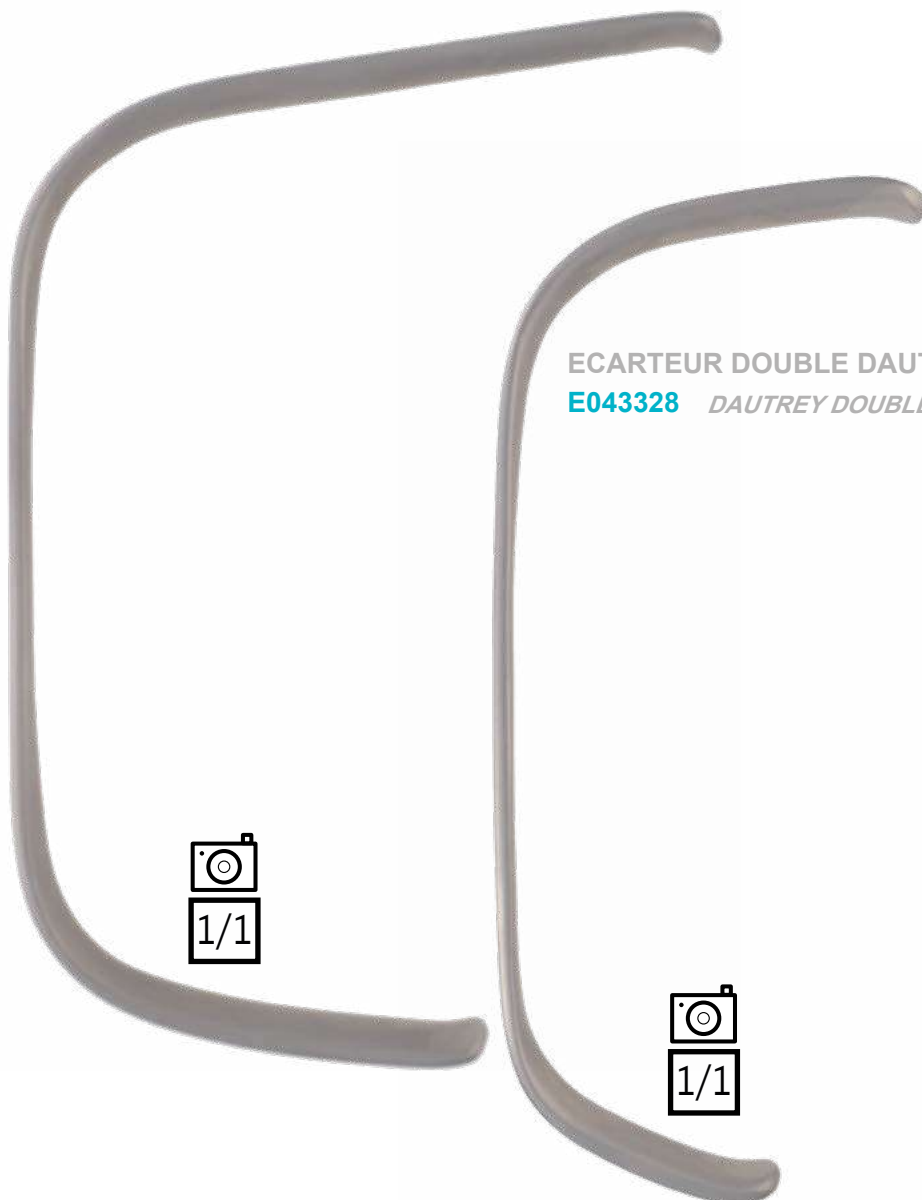

ECARTEUR DOUBLE DAUTREY PETIT MODELE PR O.R.L

E043328 DAUTREY DOUBLE RETRACTOR SMALL MODEL FOR ENT

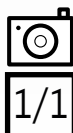

ECARTEUR DOUBLE

DOUBLE RETRACTOR

ECARTEUR DOUBLE FARABEUF 6 X 15 ET 7 X 18 X 100 MM LA PAIRE

E043329 FARABEUF DOUBLE RETRACTOR 6 X 15 AND 7 X 18 X 100 MM THE PAIR

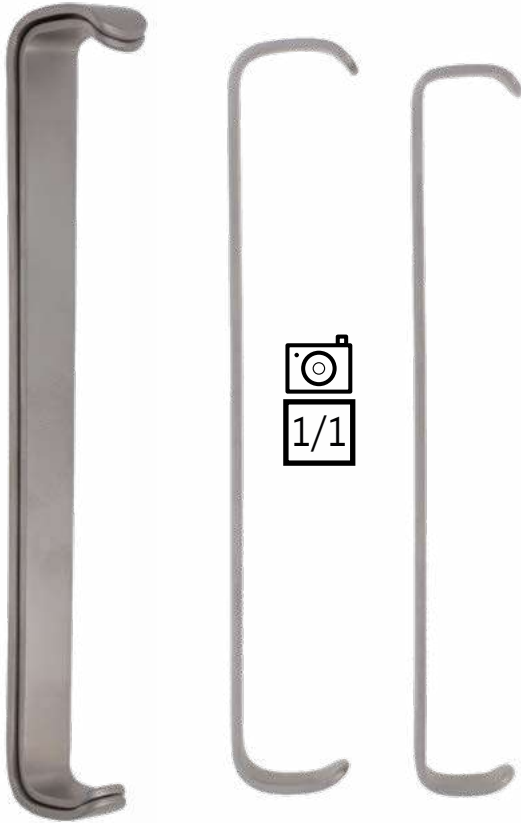

E043330

8 X 20 ET 10 X 25 X 120 MM (LA PAIRE)
(THE PAIR)

E043331

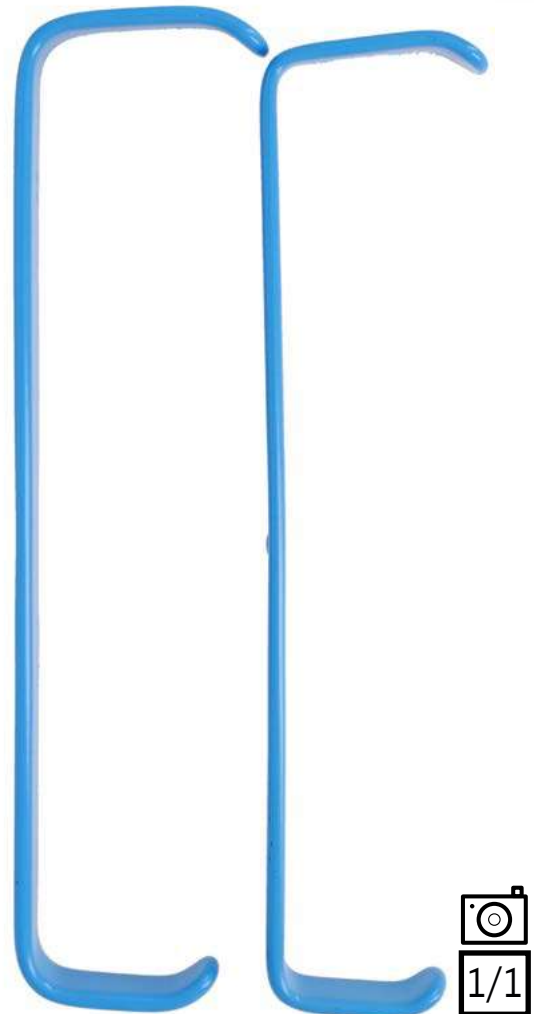
10 X 25 ET 15 X 30 X 140 MM (LA PAIRE)
(THE PAIR)

ECARTEUR DOUBLE FARABEUF CORTY
30 X 40 ET 40 X 55 X 200 MM LA PAIRE

E043333 FARABEUF CORTY DOUBLE RETRACTOR
30 X 40 AND 40 X 55 X 200 MM THE PAIR

ECARTEUR DOUBLE FREYDEL
145 MM 4 GRIFFES POINTUES

E043334 FREYDEL DOUBLE RETRACTOR
145 MM 4 TEETH SHARP

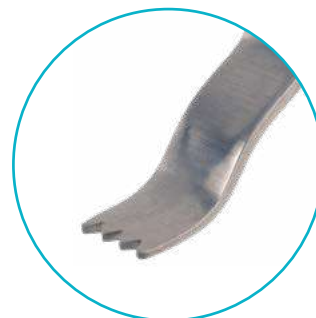
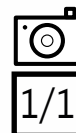
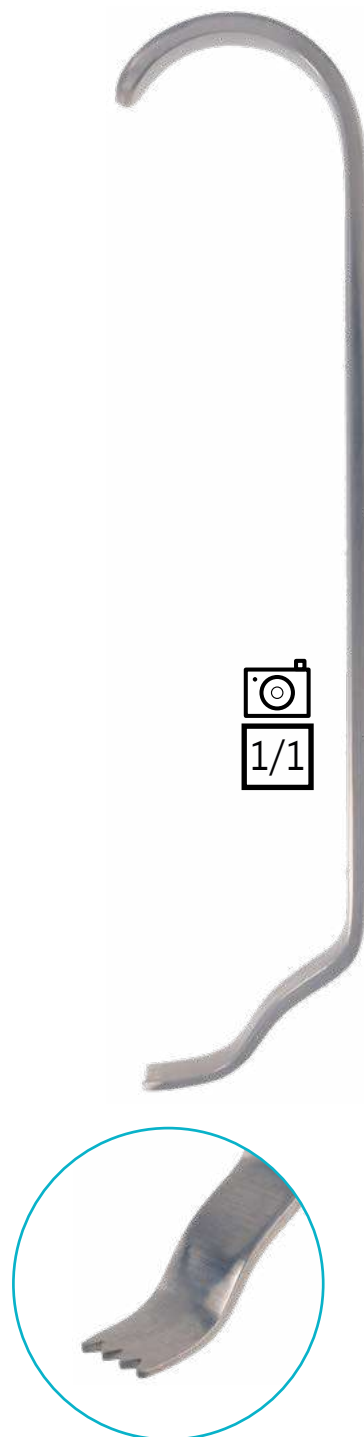
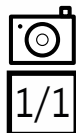
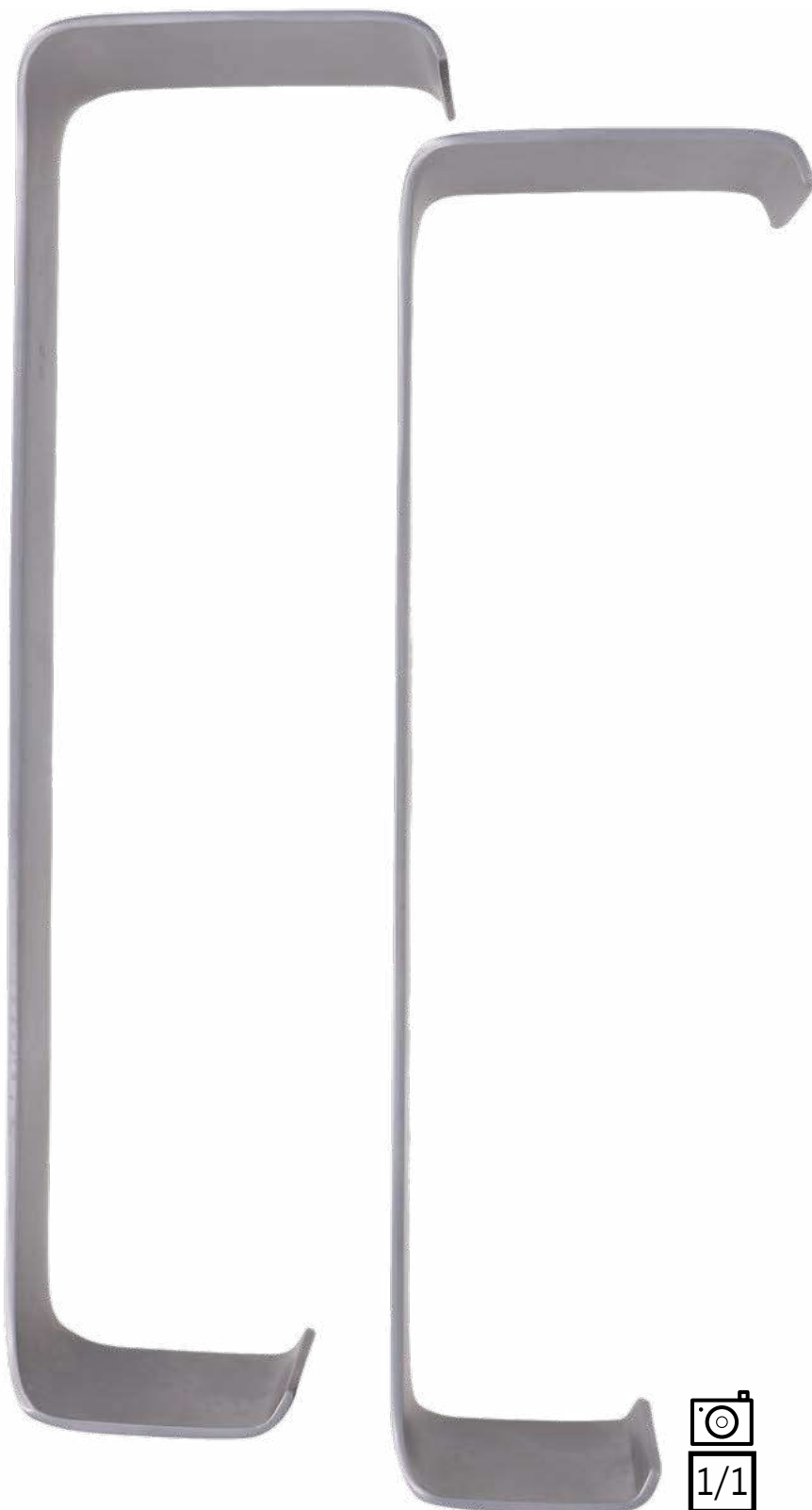

ECARTEUR DOUBLE HARTMANN 160 MM RENFORCE LA PAIRE

E043336 HARTMANN DOUBLE RETRACTOR 160 MM REINFORCED THE PAIR

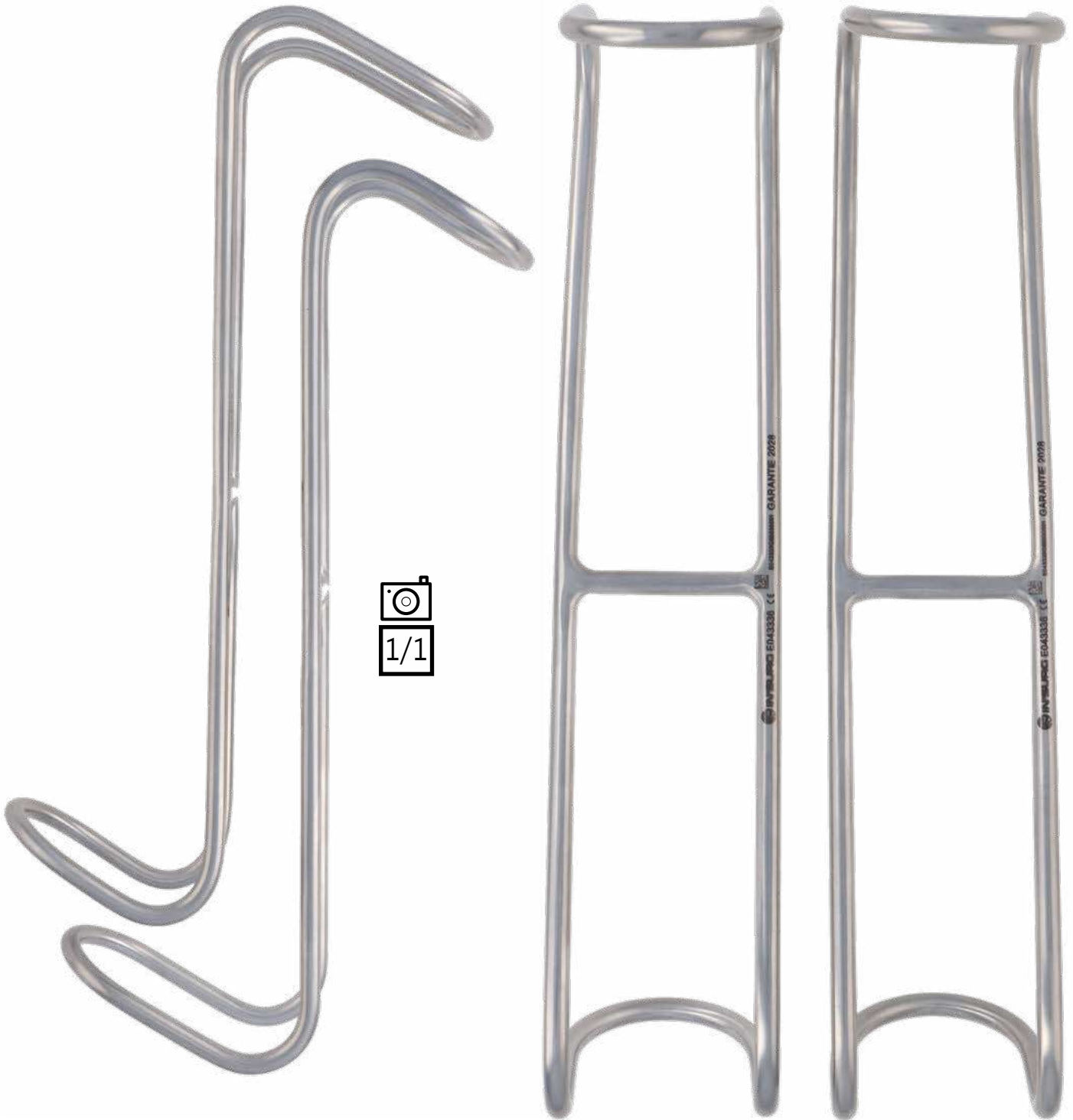

ECARTEUR DOUBLE JACKSON

6 x 9 x 170 MM

E043337 JACKSON DOUBLE RETRACTOR
6 X 9 X 170 MM



ECARTEUR DOUBLE MATHIEU

13 x 26 x 200 MM

E043340 MATHIEU DOUBLE RETRACTOR
13 X 26 X 200 MM



ECARTEUR DOUBLE LUER 10 x 12 x 110 MM

E043339 LUER DOUBLE RETRACTOR 10 X 12 X 110 MM



ECARTEUR DOUBLE

DOUBLE RETRACTOR

ECARTEUR DOUBLE NEIVERT 200 MM

E043341 *NEIVERT DOUBLE RETRACTOR 200 MM*

ECARTEUR DOUBLE PARKER 135 MM LA PAIRE

E043342 *PARKER DOUBLE RETRACTOR 135 MM
THE PAIR*

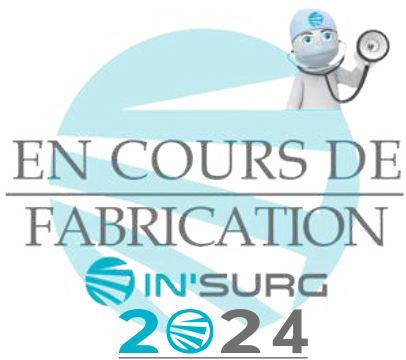

E043343
180 MM



ECARTEUR DOUBLE RAGNELL 2,5 x 5 x 145 MM

E043344 RAGNELL DOUBLE RETRACTOR
2,5 X 5 X 145 MM

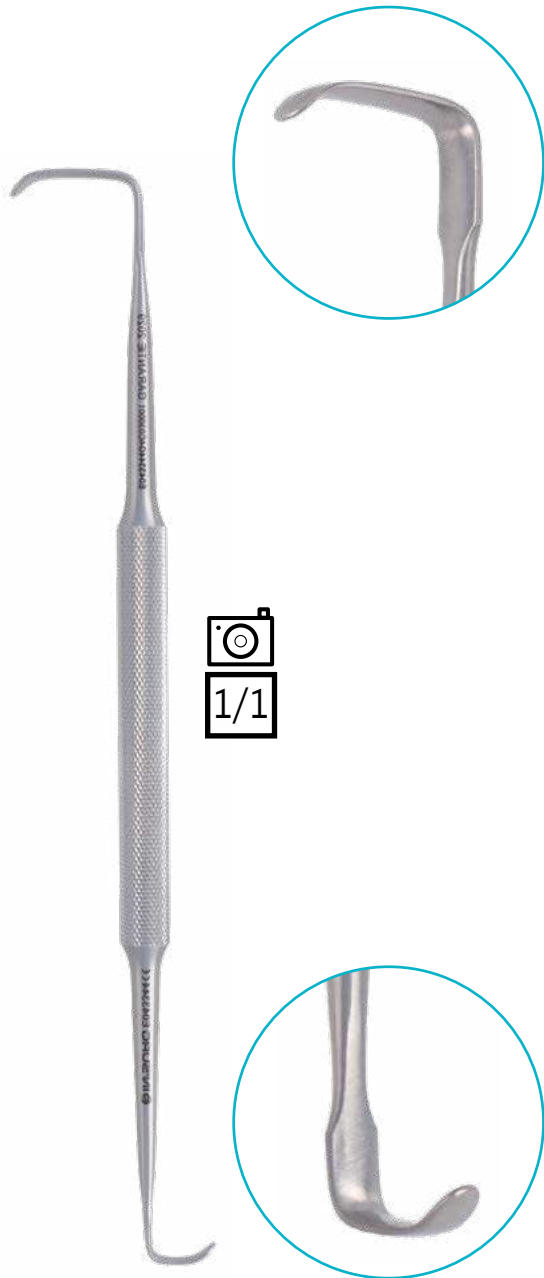

ECARTEUR DOUBLE ROSE 12 x 14 x 130 MM

E043348 ROSE DOUBLE RETRACTOR
12 X 14 X 130 MM



ECARTEUR DOUBLE

DOUBLE RETRACTOR

ECARTEUR DOUBLE RICHARDSON EASTMANN LA PAIRE

E043347 RICHARDSON EASTMANN DOUBLE RETRACTOR THE PAIR



DISPONIBLE A L'UNITE

AVAILABLE AT THE UNIT

E043345

23 X 25 / 30 X 32 X 250 MM

E043346

38 X 41 / 42 X 65 X 270 MM



ECARTEUR DOUBLE ROUX 22 X 28 X 140 MM

E043349 ROUX DOUBLE RETRACTOR 22 X 28 X 140 MM



E043352

**ECARTEUR DOUBLE ROUX
JEU DE 3**

*ROUX DOUBLE RETRACTOR SET
OF 3*

ECARTEUR DOUBLE

DOUBLE RETRACTOR

ECARTEUR DOUBLE SENN MILLER
160 MM A GRIFFES POINTUES

E043354 SENN MILLER DOUBLE
RETRACTOR 160 MM TEETH SHARP

ECARTEUR DOUBLE SENN MILLER
BABY 160 MM A GRIFFES POINTUES

E043356 SENN MILLER BABY DOUBLE
RETRACTOR 160 MM TEETH SHARP



E043353
GRIFFES MOUSSES
TEETH BLUNT

E043355
GRIFFES MOUSSES
TEETH BLUNT

ECARTEUR DOUBLE US ARMY
15 X 29 / 16 X 42 X 210 MM

E043358 *US ARMY DOUBLE RETRACTOR
15 X 29 / 16 X 42 X 210 MM*

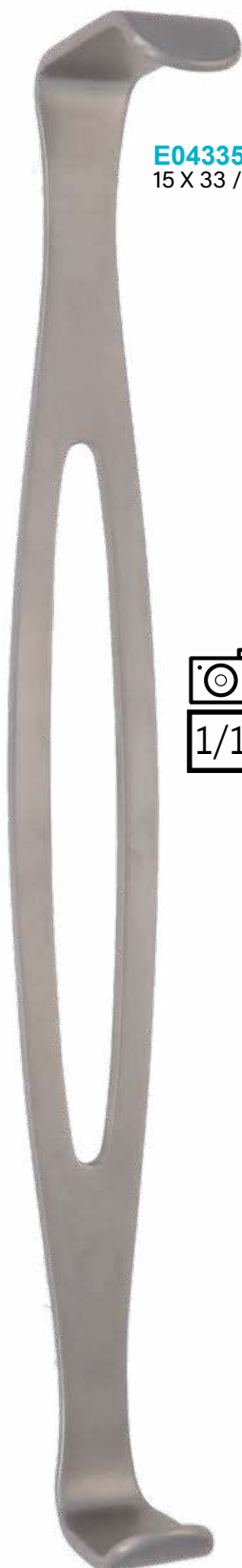

E043359
15 X 33 / 16 X 46 X 210 MM

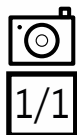

ECARTEUR DOUBLE US ARMY
210 MM JEU DE 2

E043357 *US ARMY DOUBLE RETRACTOR
210 MM SET OF 2*

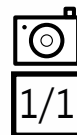
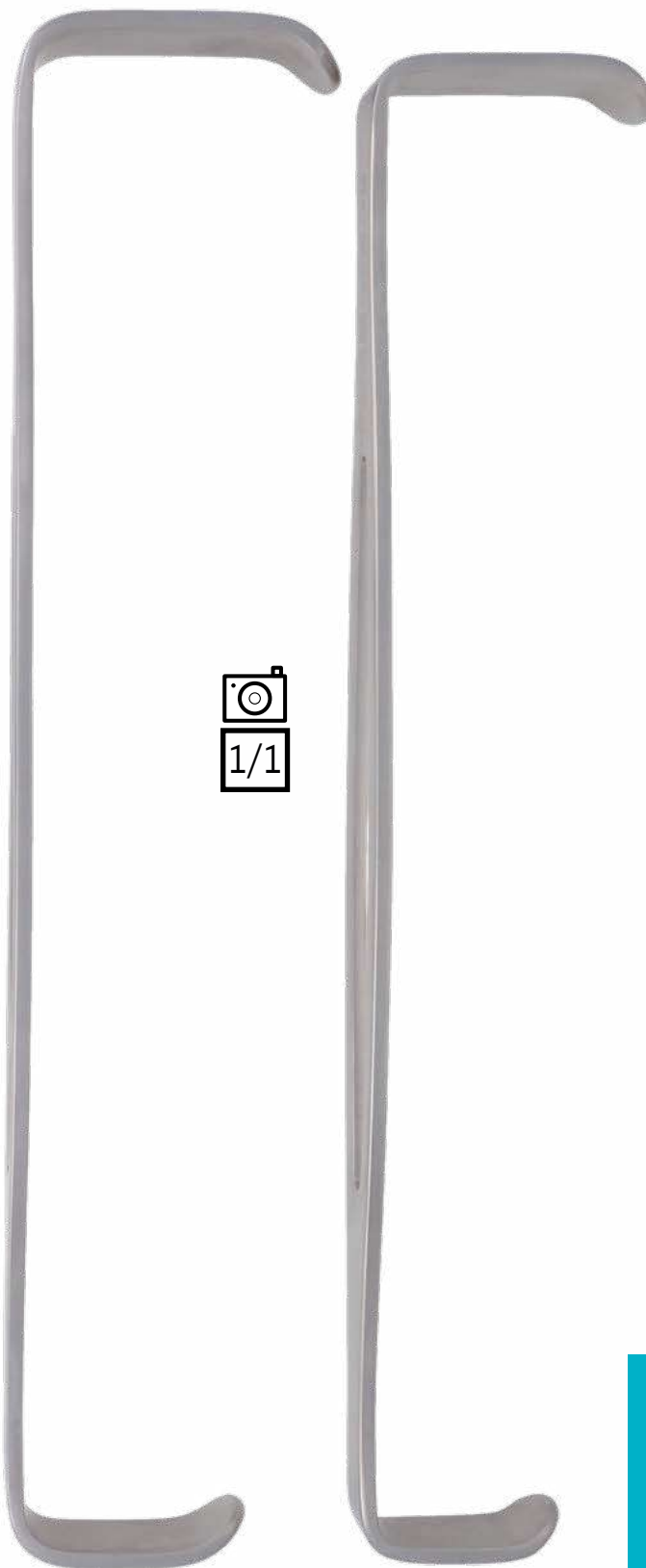

ECARTEUR THORACIQUE COSTAL BURFORD BRAS 200 MM 2 PAIRES DE VALVES
65 X 60 ET 45 X 60 MM OUVERTURE MAX 250 MM ALU

E053361 BURFORD THORACIC RETRACTOR COSTAL ARMS 200 MM 2 PAIRS OF VALVES 65 X 60
AND 45 X 60 MM OPENING MAX 250 MM ALU

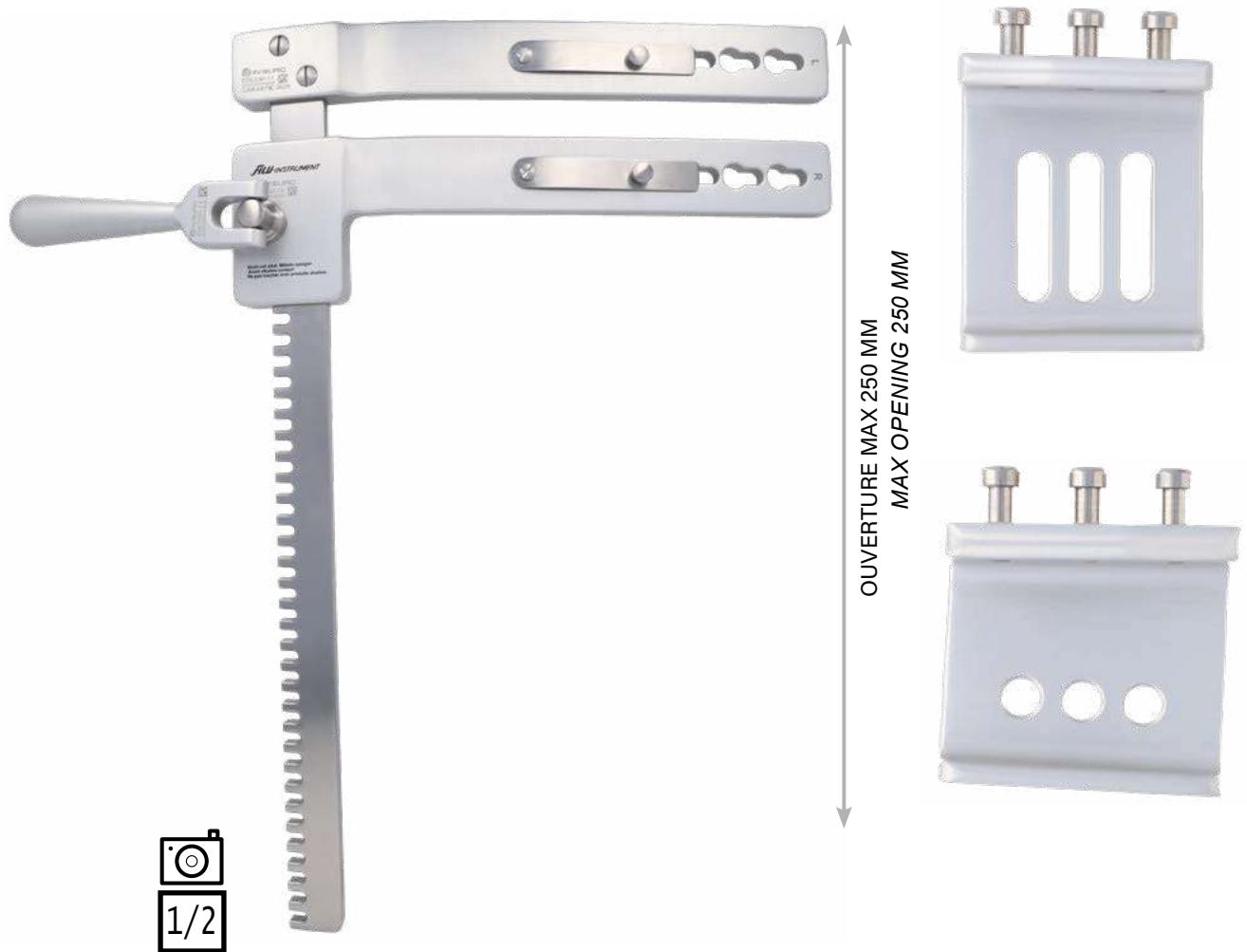

MODÈLE DISPONIBLE EN VERSION INOX

AVAILABLE MODEL IN STAINLESS STEEL

E053362

190 MM 65 X 70 ET 40 X 65 MM
OUVERTURE MAX 250 MM
MAX OPENING 250 MM

E053363

190 MM 65 X 70 ET 40 X 65 MM
OUVERTURE MAX 300 MM
MAX OPENING 300 MM

ECARTEUR THORACIQUE DEBAKEY 180 x 150 MM SANS VALVE OUVERTURE MAX 190 M
E053372 *DEBAKEY THORACIC RETRACTOR 180 X 150 MM WITHOUT VALVE OPEN MAX 190MM*



E053373
225 X 200 MM

PAIRE DE VALVES PR ECARTEUR THORACIQUE DEBAKEY 30 x 30 MM
E053364 *PAIR OF VALVE FOR DEBAKEY THORACIC RETRACTOR 30 X 30 MM*

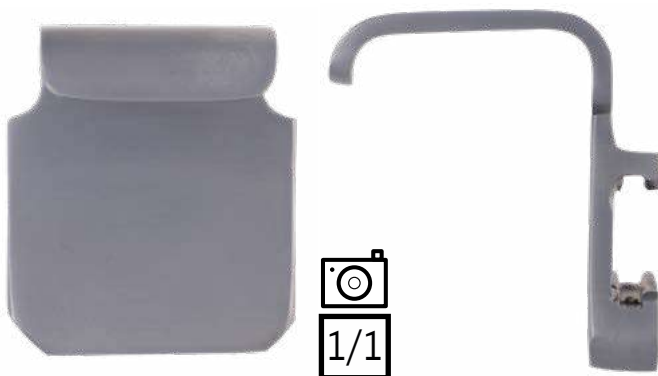

E053365
40 X 40 MM

E053366
40 X 100 MM

E053367
50 X 50 MM

E053368
50 X 66 MM

E053369
50 X 80 MM

E053370
60 X 60 MM

E053371
80 X 60 MM

ECARTEUR THORACIQUE FINOCHIETTO 40 X 45 X 130 MM OUVERTURE MAX 180 MM

E053376 FINOCHIETTO THORACIC RETRACTOR 40 X 45 X 130 MM OPENING MAX 180 MM

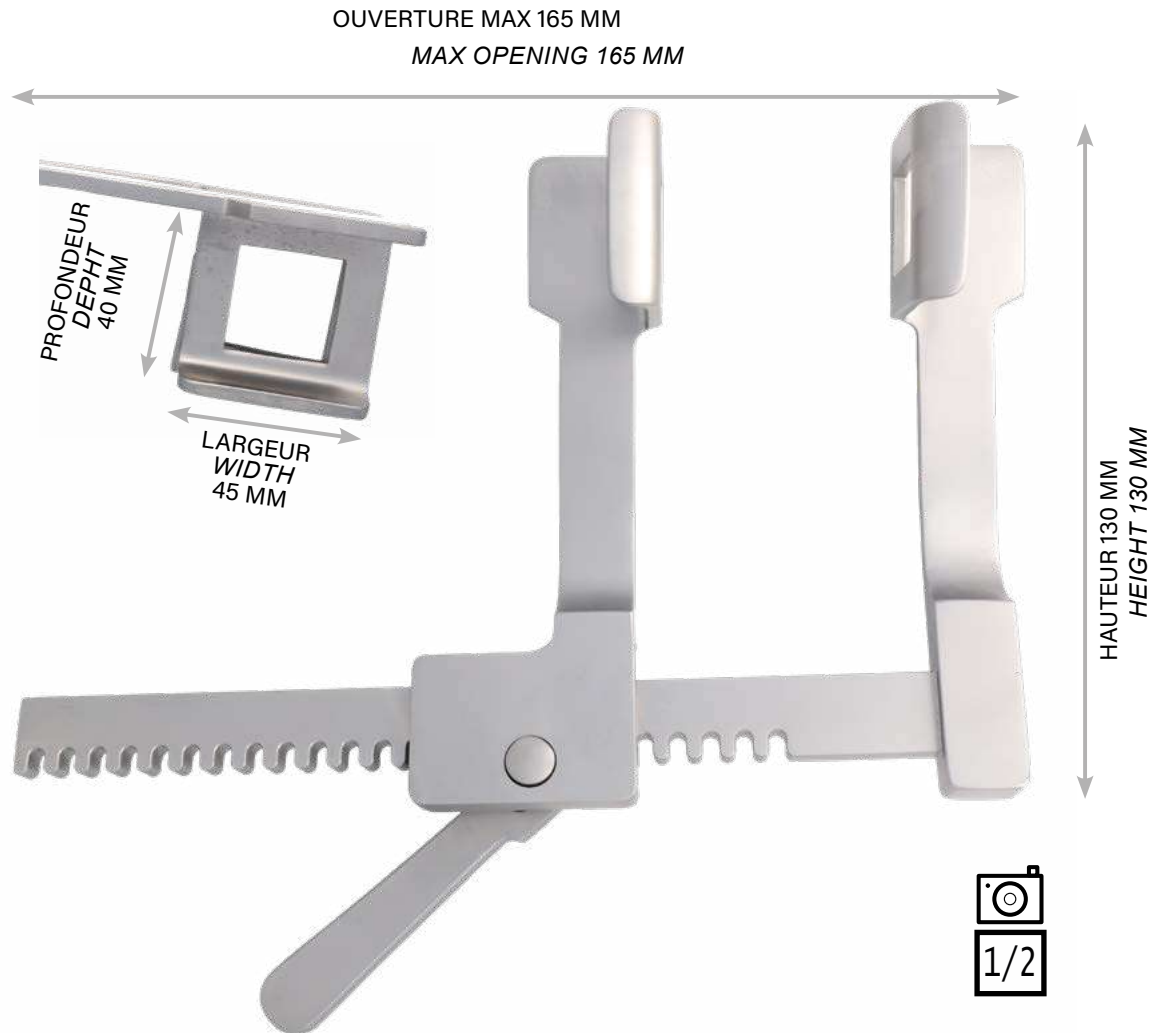

REFERENCE ITEMS	OUVERTURE OPENING	PROFONDEUR DEPTH	LARGEUR WIDTH	HAUTEUR HEIGHT
E053374	80 MM	20 MM	20 MM	75 MM
E053375	85 MM	25 MM	40 MM	114 MM
E053376	180 MM	40 MM	45 MM	130 MM
E053377	200 MM	45 MM	65 MM	180 MM

ECARTEUR THORACIQUE COSTAL HAIGH BRAS 90 MM VALVES 30 X 30 MM OUVERTURE MAX 120 MM
E053378 HAIGH THORACIC RETRACTOR COSTAL ARMS 90 MM VALVES 30 X 30 MM OPENING MAX 120 MM



ECARTEUR THORACIQUE TUFFIER VALVES 46 x 50 MM
E053385 TUFFIER THORACIC RETRACTOR VALVES 46 X 50 MM



ECARTEUR THORACIQUE MORSE ADULTE OUVERTURE 200 MM
E053394 MORSE THORACIC RETRACTOR ADULT OPENING 200 MM

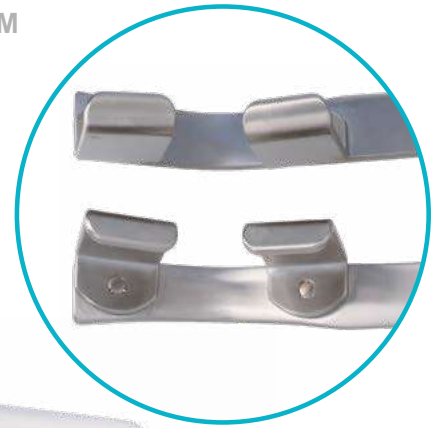

OUVERTURE MAX 200 MM
MAX OPENING 200 MM

E053395
ENFANT
OUV. MAX 160 MM
CHILDREN
MAX OPENING 160 MM

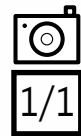

ECARTEUR THORACIQUE COOLEY XXL SELON COSGROVE COMPLET AVEC VALVES ET SUPPORT

E053406

COOLEY XXL THORACIC RETRACTOR CROSGROVEE PROCESS FULL WITH VALVES AND SUPPORT

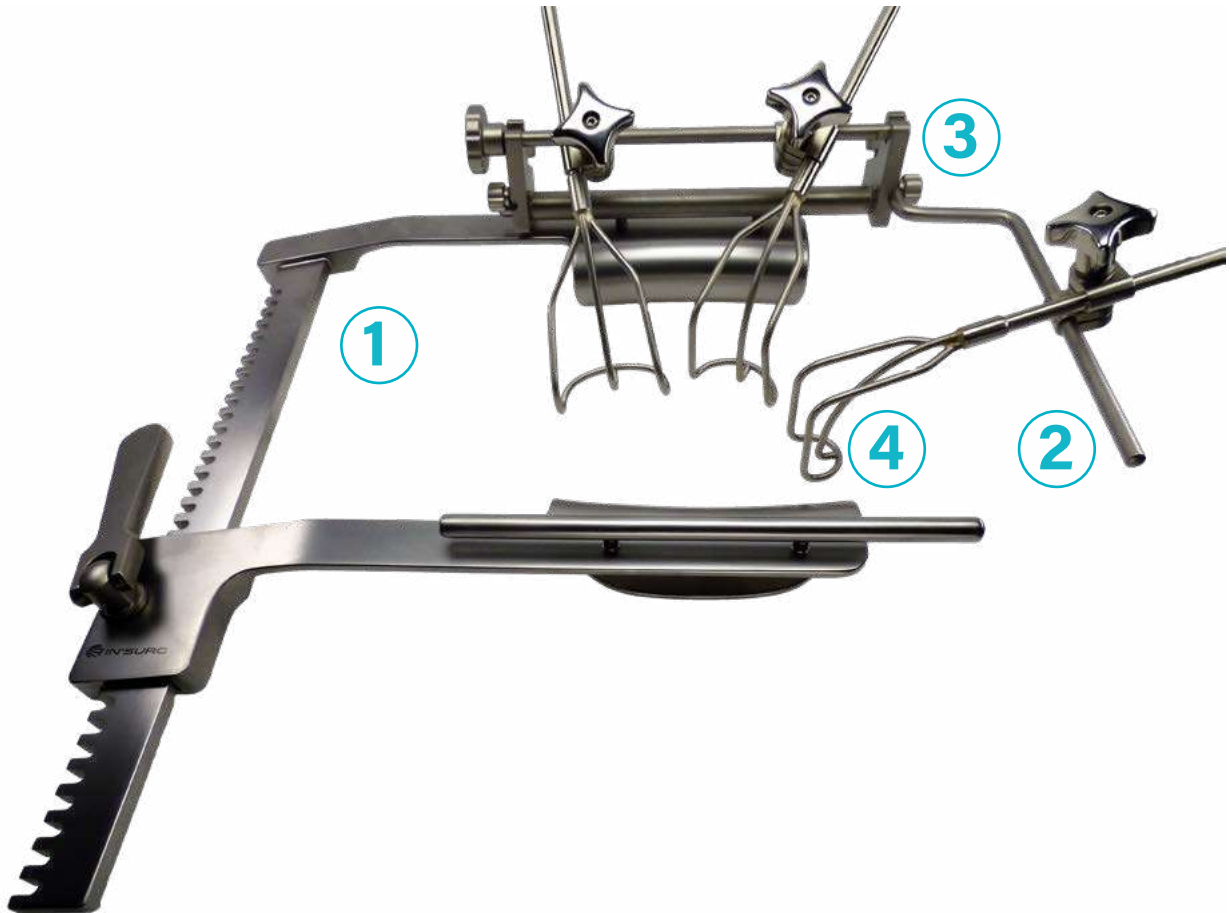

E053407

1

ECARTEUR THORACIQUE COOLEY XXL SELON COSGROVE CADRE SEUL 230 MM OUVERTURE MAX 205 MM

COOLEY XXL THORACIC RETRACTOR BY CROSGROVE FRAME ONLY 230MM MAX OPENING 205 MM

E053408

2

BARRE POUR FIXATION LATÉRALE POUR ECARTEUR THORACIQUE COOLEY XXL

BAR FOR LATERAL FIXATION FOR COOLEY XXL THORACIC RETRACTOR

E053409

3

SUPPORT POUR VALVE MITRAL POUR ECARTEUR THORACIQUE COOLEY XXL

MITRAL VALVE SUPPORT FOR COOLEY XXL THORACIC RETRACTOR

E053410

4

VALVE MALLEABLE COOLEY 50 X 20 MM MANCHE ROND PROFILE BAS POUR ECARTEUR THORACIQUE COOLEY XXL

COOLEY MALLEABLE VALVE 50 X 20 MM ROUND HANDLE FOR COOLEY XXL THORACIC RETRACTOR

ECRASEUR/ETAU

*INTESTINAL AND
PYLORUS CLAMPS*



ECRASEUR/ETAU JOST STRIE
E063396 *JOST FLATENEUR / VICE SERRATED*

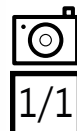

ECRASEUR / ETAU

INTESTINAL AND PYLORUS CLAMPS

ECRASEUR INTESTINAL DEMARTEL
90 MM

E063397 *DEMARTEL INTESTINAL AND
PYLORUS CLAMPS 90 MM*



E063398
110 MM



ECRASEUR INTESTINAL DEMARTEL
PINCE LEVIER 250 MM

E063399 *DEMARTEL INTESTINAL AND
PYLORUS LEVER CLAMPS
250 MM*

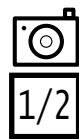

ECRASEUR INTESTINAL PAYRE
150 MM

E063400 *PAYRE INTESTINAL AND
PYLORUS CLAMPS 150 MM*



E063401
200 MM

E063402
290 MM

E063403
350 MM

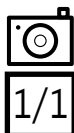

ELEVATOR

ELEVATEUR ADSON 8 x 170 MM BISAUTE

E073404 ADSON ELEVATOR 8 X 170 MM
BEVELLED

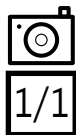

ELEVATEUR ADSON 6 x 170 MM
COURBE TRANCHANT

E073406 ADSON ELEVATOR 6 X 170 MM
CURVED SHARP

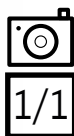

ELEVATEUR ADSON 6 x 170 MM
DEMI-COURBE MOUSSE

E073405 ADSON ELEVATOR 6 X 170 MM
HALF CURVED BLUNT

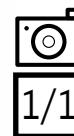

ELEVATEUR ADSON 6 x 170 MM
DROIT MOUSSE

E073426 ADSON ELEVATOR 6 X 170 MM
STRAIGHT BLUNT

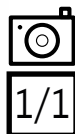

ELEVATEUR ADSON 6 x 170 MM
DROIT TRANCHANT

E073407 ADSON ELEVATOR 6 X 170 MM
STRAIGHT SHARP

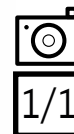

ELEVATEUR

ELEVATOR

ELEVATEUR CUSHING 15 x 180 MM
DEMI COURBE

E073408 CUSHING ELEVATOR 15 X 180 MM
HALF CURVED

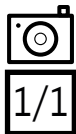

ELEVATEUR DANIS 45 x 240 MM EN CUILLERE

E073409 DANIS ELEVATOR 45 X 240 MM SPOON FORM

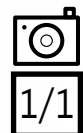

ELEVATEUR GUIOT 220 MM A RACINES
E073410 GUIOT ELEVATOR 220 MM FOR ROOT

ELEVATEUR KEY 6 x 190 MM DEMI COURBE TRANCHANT
E073411 KEY ELEVATOR 6 X 190 MM HALF CURVED SHARP



ELEVATEUR

ELEVATOR

ELEVATEUR DOUBLE LAMBOTTE
15 - 30 x 290 MM CUILLERE

E073416 LAMBOTTE ELEVATOR 15 - 30 X 290 MM
DOUBLE SPOON

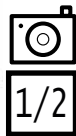

ELEVATEUR SIMPLE LAMBOTTE
25 x 290 MM LEVIER

E073417 LAMBOTTE ELEVATOR 25 X 290 MM
SINGLE LEVER

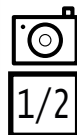

ELEVATEUR LANGENBECK 7 x 190 MM MOUSSE

E073420 LANGENBECK ELEVATOR 7 X 190 MM
BLUNT



E073421
15 x 190 MM TRANCHANT
SHARP



E073418
13 x 180 MM COUDE A 90°
ANGLED 90°

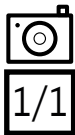

ELEVATEUR LANGENBECK MARTIN 5 x 170 MM

E073419 LANGENBECK MARTIN ELEVATOR
5 X 170 MM

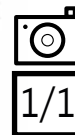

ELEVATEUR DOUBLE PENNINGTON 210 MM

E073423 PENNING DOUBLE ELEVATOR 210 MM

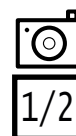

ELEVATEUR

ELEVATOR

ELEVATEUR LEBEAU 195 MM SOULEVE VOLET

E073422 LEBEAU ELEVATOR 195 MM RAISED FLAP

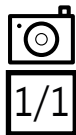

ELEVATEUR 3,3 X 165 MM

LEGEREMENT COURBE TRANCHANT

E073427 ELEVATOR 3,3 X 165 MM SLIGHTLY CURVED SHARP

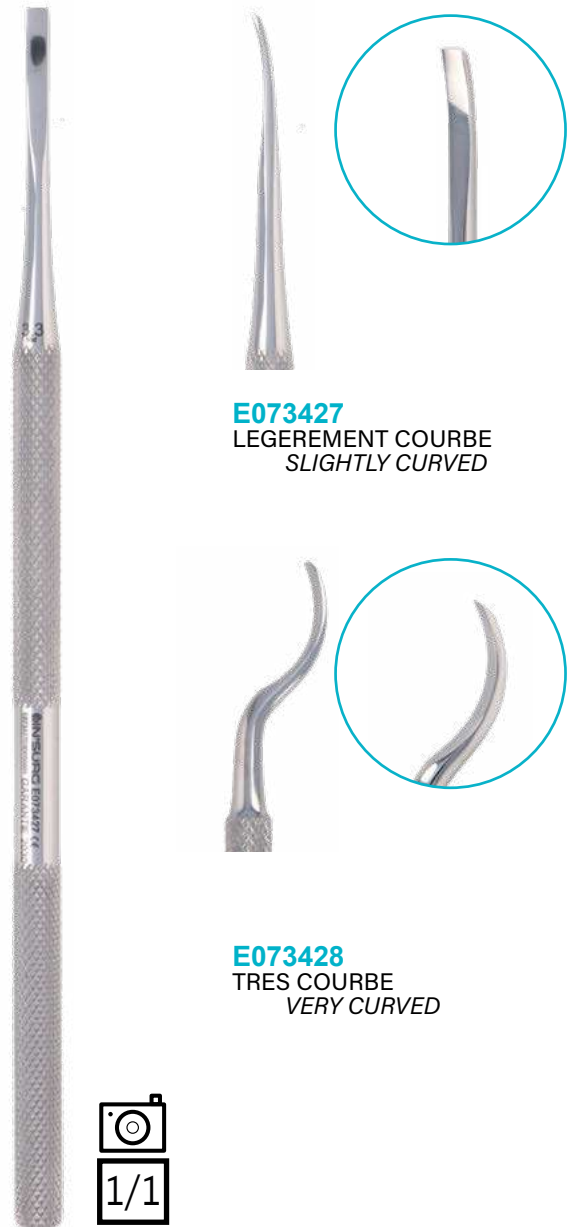

E073427
LEGEREMENT COURBE
SLIGHTLY CURVED

E073428
TRES COURBE
VERY CURVED



ETRIER

www.in-surg.fr

E

TRACTIONS BOWS

ETRIER BOELHER 150 x 210 MM

E083428 BOELHER TRACTIONS BOWS 150 X 210 MM



E083426
90 X 160 MM

E083427
110 x 160 MM



ETRIER CRANIEN CRUTCHFIELD GRAND MODELE

E083429 *CRUTCHFIELD CRANIALTRACTIONS BOWS LARGE MODEL*

E083430

PETIT MODELE

SMALL MODEL



PAIRE DE MECHEs 1 X DIAM 3.5 + 1 X DIAM 5.0 MM POUR ETRIER CRUTCHFIELD

E083431 *PAIR OF DRILL 1 X DIAM 3.5 + 1 X DIAM 5.0 MM FOR CRUTCHFIELD CRANIALTRACTIONS BOWS*



ETRIER KIRSCHNER OUVERTURE MAX 110 MM AVEC 3 CROCHETS

E083434 KIRSCHNER TRACTIONS BOWS OPENING MAX 110 MM WITH 3 HOOKS

E083433
OUVERTURE MAX 70 MM
MAX OPENING 70 MM

E083435
OUVERTURE MAX 130 MM
MAX OPENING 130 MM

E083436
OUVERTURE MAX 155 MM
MAX OPENING 155 MM

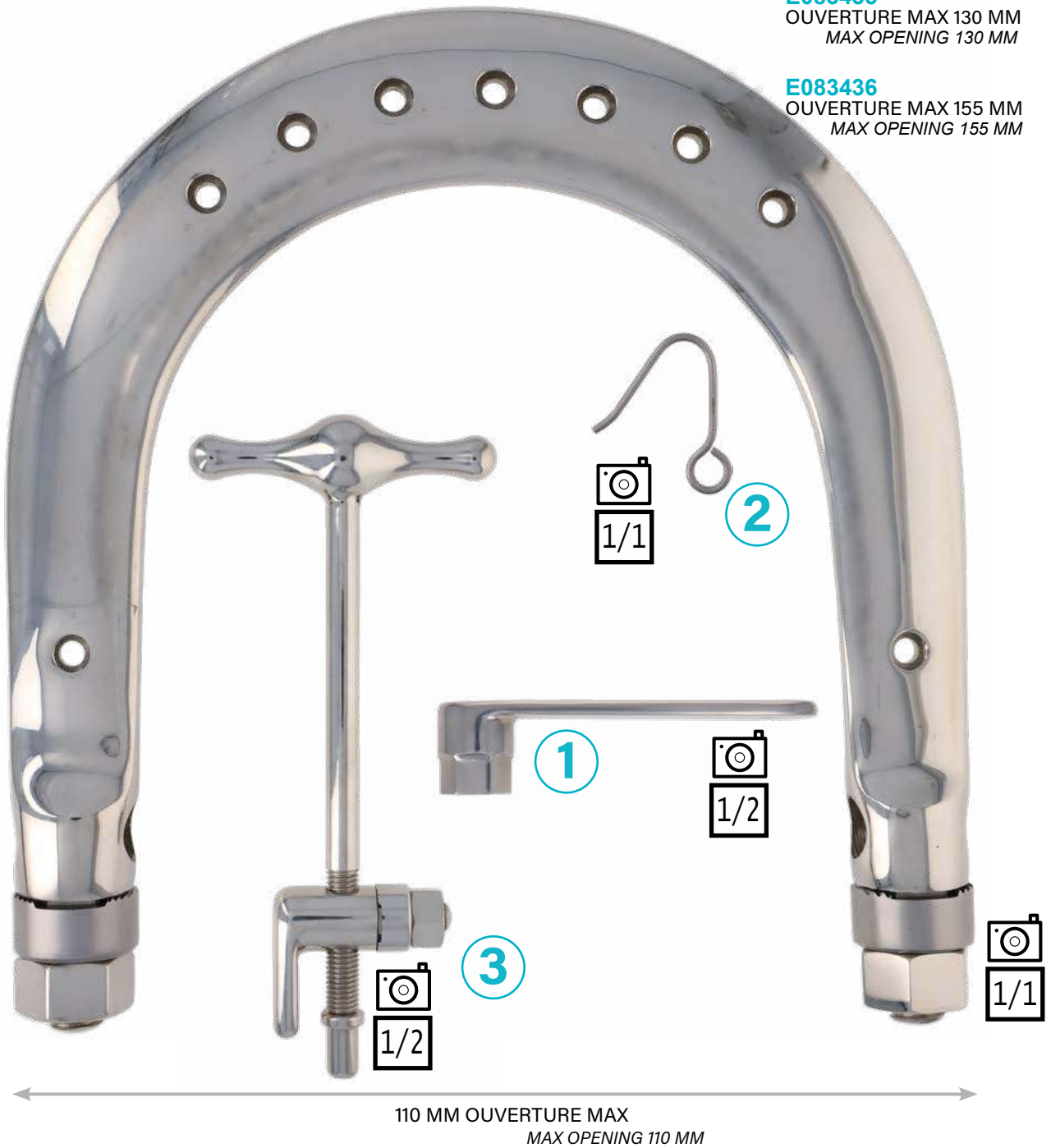

110 MM OUVERTURE MAX
MAX OPENING 110 MM

1

E083437 CLE DE SERRAGE PR ETRIER KIRSCHNER L'UNITE

WRENCH FOR KIRSCHNER TRACTIONS BOWS UNIT

2

E083438 CROCHET PR ETRIER KIRSCHNER L'UNITE

HOOK FOR KIRSCHNER TRACTIONS BOWS UNIT

3

E083439 TENDEUR PR ETRIER KIRSCHNER L'UNITE

TENSIONER FOR KIRSCHNER TRACTIONS BOWS UNIT

EXTRACTEUR DE MOORE POIGNEE SOFT GRIP EN T 225 MM

E093444 *MOORE EXTRACTOR T FORM WITH SOFT GRIP HANDLE*

EXTRACTEUR DE LAMBOTTE TOUT INOX POIGNEE EN T 280 MM

E096262 LAMBOTTE EXTRATOR WITH T-HANDLE ALL STAINLESS STEEL 280 MM



SOMMAIRE

FORCEPS	681
<i>OBSTETRICAL FORCEPS</i>	
FOURCHE	690
<i>FORK</i>	



F

RETRO 'SPECTIVE

Louis Hubert FARABEUF
(6 mai 1841 - 13 août 1910)

était un **chirurgien** français à qui l'on attribue l'**introduction de l'hygiène dans l'enseignement médical** français. Il rédige plusieurs opuscules de chirurgie et **invente un certain nombre d'instruments médicaux** (pinces, écarteurs, scies, rugines, davier...)

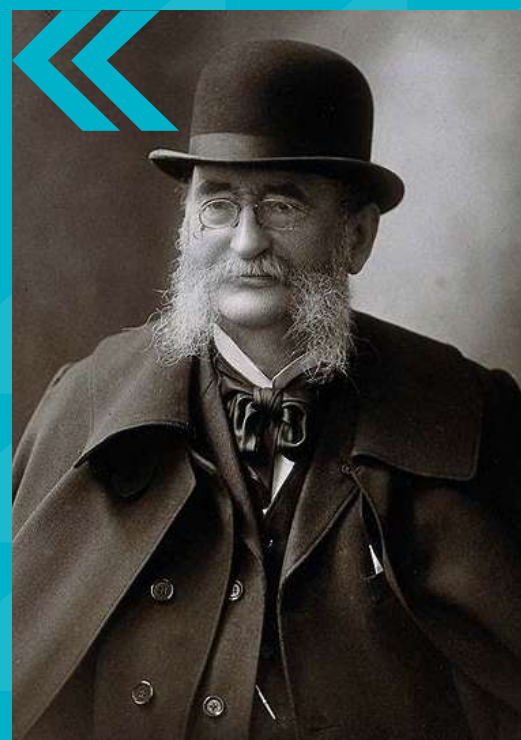

FORCEPS
OBSTETRICAL FORCEPS

FORCEPS BOERMA 290 MM
F023449 BOERMA OBSTETRICAL FORCEPS 290 MM

FORCEPS ELLIOT 320 MM
F023454 ELLIOT OBSTETRICAL FORCEPS 320 MM



F023455
380 MM

TIGE MEDIANE PR FORCEPS
DEMELIN SUZOR L'UNITE

F023452 *MEDIAN ROD FOR DEMELIN SUZOR
OBSTETRICAL FORCEPS UNIT*

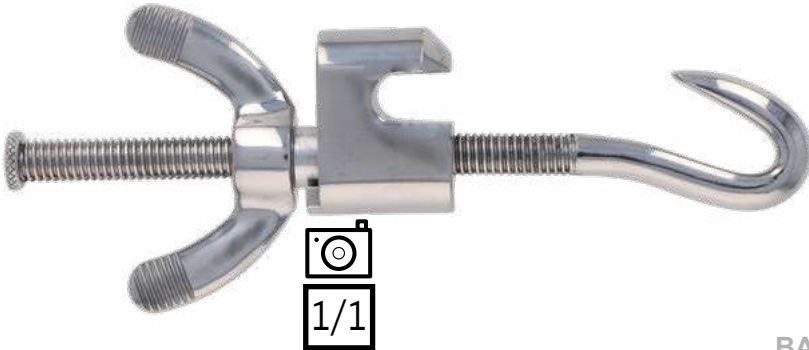

VIS PR FORCEPS DEMELIN SUZOR L'UNITE

F023453 *SCREW FOR DEMELIN SUZOR
OBSTETRICAL FORCEPS UNIT*



BARRE DE FIXATION PR FORCEPS
DEMELIN SUZOR L'UNITE

F023451 *FIXING BAR FOR DEMELIN SUZOR
OBSTETRICAL FORCEPS UNIT*

FORCEPS DEMELIN SUZOR 320 MM

F023450 *DEMELIN SUZOR OBSTETRICAL FORCEPS 320 MM*



FORCEPS

OBSTETRICAL FORCEPS

FORCEPS KIELAND 410 MM

F023456 *KIELAND OBSTETRICAL FORCEPS 410 MM*

FORCEPS KIELAND LUIKART 400 MM

F023457 *KIELAND LUIKART OBSTETRICAL FORCEPS 400 MM*



FORCEPS LUIKART 400 MM

F023459 LUIKART OBSTETRICAL FORCEPS 400 MM

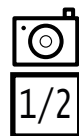

FORCEPS

OBSTETRICAL FORCEPS

FORCEPS PAJOT 360 MM

F023463 PAJOT OBSTETRICAL FORCEPS 360 MM

FORCEPS SELLHEIM 280 MM EN CUILLERE

F023465 SELLHEIM OBSTETRICAL FORCEPS 280 MM SPOON FORM



FORCEPS PIPER 440 MM

F023464 PIPER OBSTETRICAL FORCEPS 440 MM

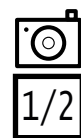

FORCEPS

OBSTETRICAL FORCEPS

FORCEPS SIMPSON BRAUN 360 MM

F023468 *SIMPSON BRAUN OBSTETRICAL FORCEPS 360 MM*



FORCEPS TARNIER 400 MM AVEC TRACTEUR

F023469 *TARNIER OBSTETRICAL FORCEPS 400 MM WITH TRACTION BAR*

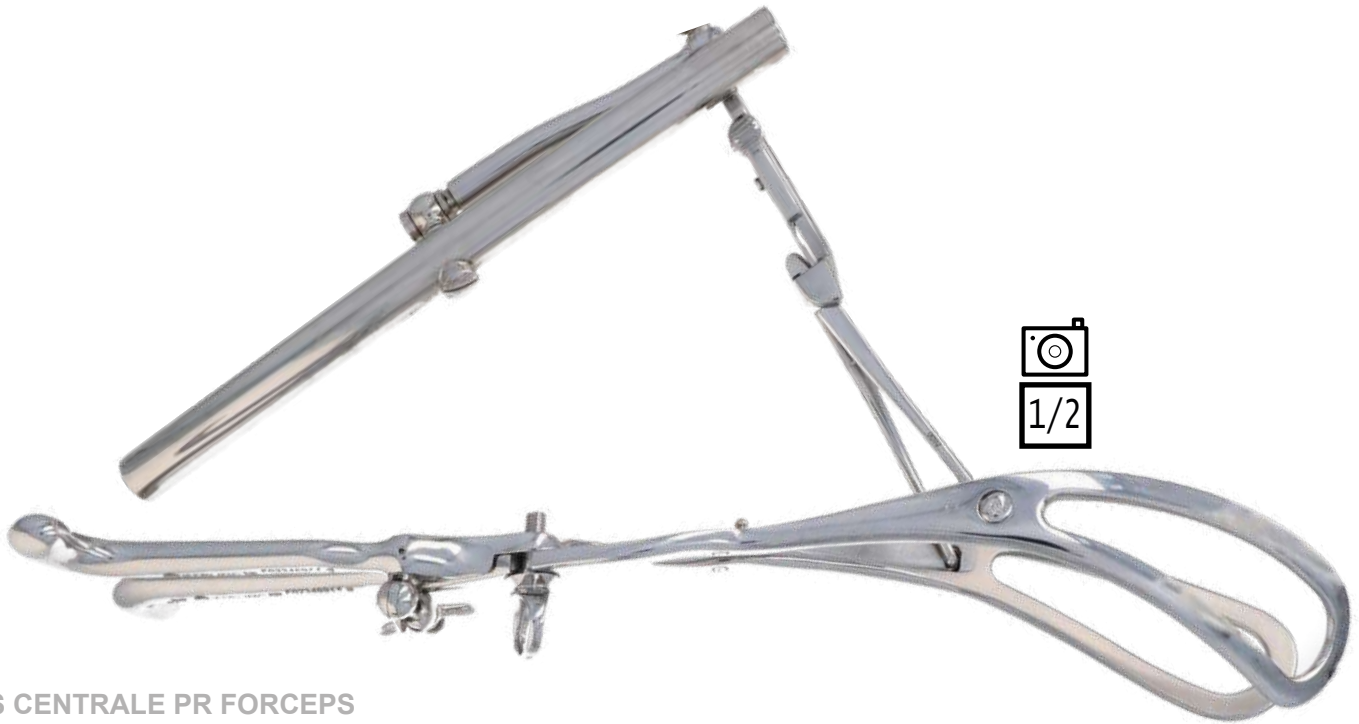

VIS CENTRALE PR FORCEPS TARNIER L'UNITE

F023471 *CENTRAL SCREW FOR TARNIER OBSTETRICAL FORCEPS UNIT*



TIGE REGLABLE PR FORCEPS TARNIER AVEC VIS

F023470 *ADJUSTABLE ROD FOR TARNIER OBSTETRICAL FORCEPS WITH SCREW*

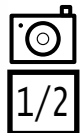

TRACTEUR PR FORCEPS TARNIER L'UNITE

F023472 *TRACTION BAR FOR TARNIER OBSTETRICAL FORCEPS UNIT*

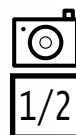

FORCEPS

OBSTETRICAL FORCEPS

FORCEPS THIERRY 390 MM LA PAIRE DE SPATULES

F023476 THIERRY OBSTETRICAL FORCEPS 390 MM PAIRE OF SPATULAS

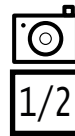
F023475
360 MM

FOURCHE

www.in-surg.fr

F

FORK

FOURCHE YASARGIL 8 X 230 MM

F043489 YASARGIL FORK 8 X 230 MM

FOURCHE YASARGIL 185 MM EN FIL

F043488 YASARGIL FORK 185 MM YARN

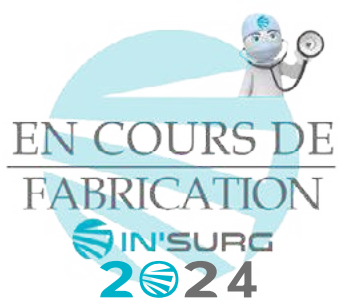



SOMMAIRE

GUIDE MECHE **693**
DRILL GUIDE



G

RETRO 'SPECTIVE

Sir Harold Delf GILLIES (17 juin 1882 - 10 septembre 1960)

était un **médecin** britannique considéré comme l'**un des pères de la chirurgie esthétique**. Il enseigne partout dans le monde et publie en 1920 son Plastic Surgery of the Face, qui établit définitivement cette science artistique comme une spécialité de la médecine. En 1946, il devient l'**un des premiers au monde à pratiquer la chirurgie de mutation sexuelle**.

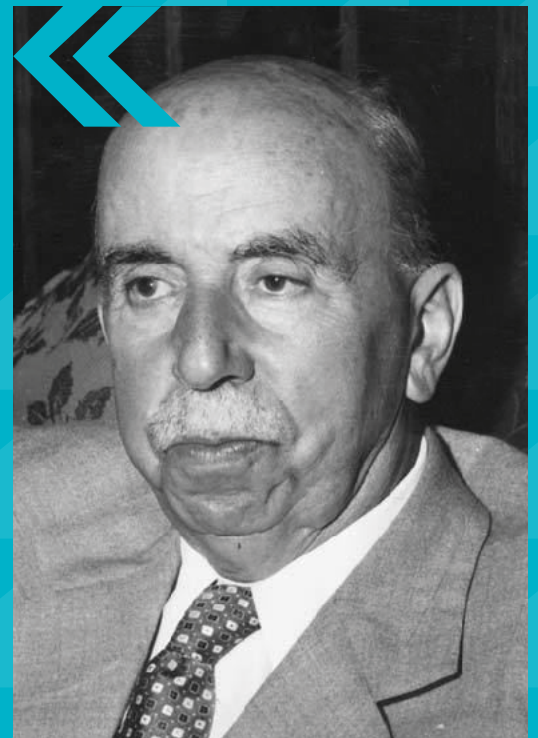

GUIDE MECHE DIAM 2.5 / 3.5 MM SIMPLE

G013492 *GUIDE DRILL DIAM 2,5 / 3,5 MM SIMPLE*



1/1

GUIDE MECHE DIAM INT. 1,5 MM EXT. 2,0 MM NEUTRE

G013493 *GUIDE DRILL DIAM INT. 1,5 MM EXT. 2,0 MM NEUTRE*

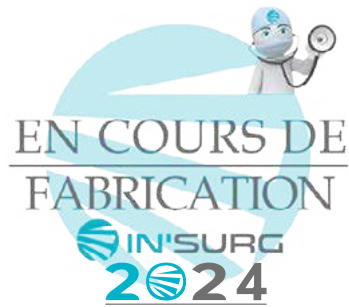

G013494
DIAMETRE INT 2,0 MM
DIAMETRE EXT 2,7 MM

G013495
DIAMETRE INT 2,5 MM
DIAMETRE EXT 3,5 MM

G013496
DIAMETRE INT 3,2 MM
DIAMETRE EXT 4,5 MM



SOMMAIRE

HYSTEROMETRE..... 697
UTERINES PROBES



H

RETRO 'SPECTIVE

William Stewart HALSTED
(23 septembre 1852 - 7 septembre 1922)

était un **chirurgien** américain surtout connu comme l'**un des pionniers de l'asepsie et de l'anesthésie chirurgicale**. Il est également connu pour avoir mis au point plusieurs procédés opératoires, parmi lesquels la **mastectomie radicale** appliquée à la lutte contre le cancer du sein.

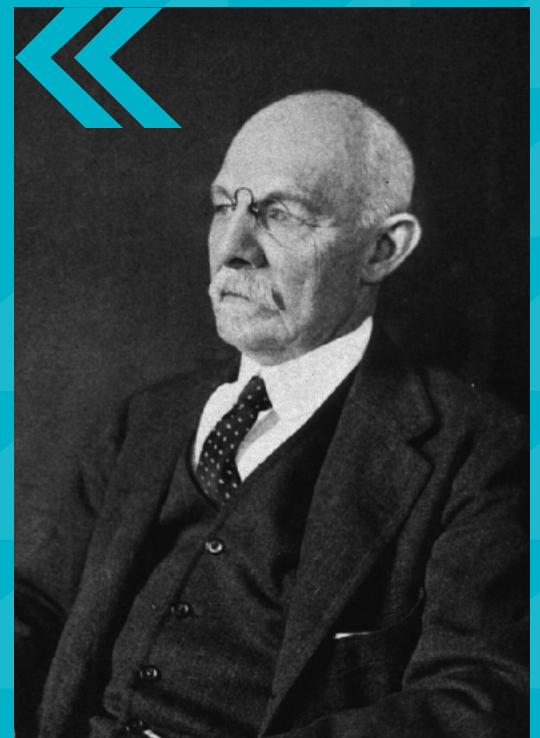

HYSTEROMETRE

UTERINES PROBES

HYSTEROMETRE SIMS 330 MM MALLEABLE - NON CALIBRE

H023499 UTERINES PROBES SIMS 330 MM MALLEABLE UNCALIBRATED

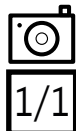

HYSTEROMETRE VALLEIX 290 MM - NON CALIBRE

H023500 *UTERINES PROBES VALLEIX 290 MM UNCALIBRATED*

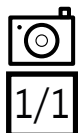

SOMMAIRE

LAME MALLEABLE	701
<i>MALLEABLE BLADE</i>	
LEVIER	704
<i>LEVER</i>	



L

RETRO 'SPECTIVE

Joseph LISTER (5 avril 1827 - 10 février 1912)

était un **chirurgien** britannique. Il est **l'un des pionniers ainsi que le vulgarisateur le plus efficace de l'antisepsie dans la chirurgie opératoire**. Afin de tuer les micro-organismes présents dans l'air ambiant, Lister **vaporise du phénol**. Il parvient ainsi en 1869 à réduire le taux de mortalité opératoire de 60 à 15%.

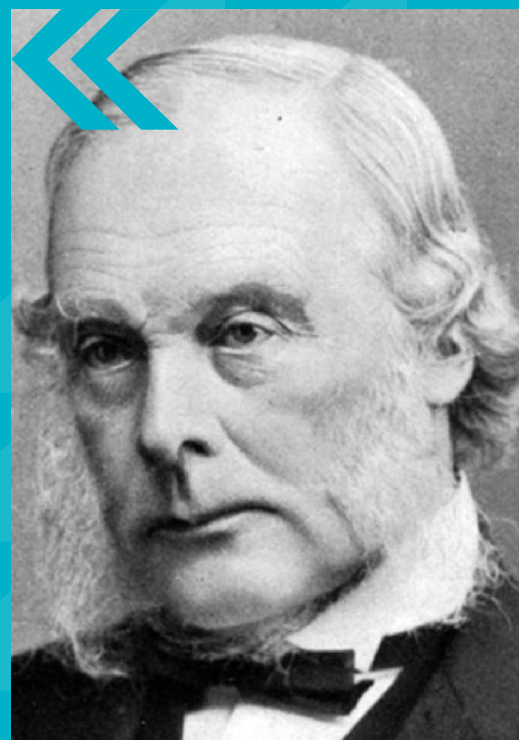

LAME MALLEABLE

MALLEABLE BLADE

LAME 20 X 330 MM MALLEABLE

L013504 MALLEABLE BLADE 20 X 330 MM

LAME CHEVRET 60 X 300 MM MALLEABLE

L013510 CHEVRET MALLEABLE BLADE 60 X 300 MM



L013505
25 X 330 MM

L013506
30 X 330 MM

L013507
40 X 330 MM

L013508
50 X 330 MM

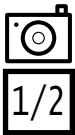

L013509
40 X 300 MM

L013511
80 X 300 MM

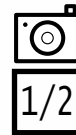

LAME DAVIS 17 X 200 MM MALLEABLE

L013514 DAVIS MALLEABLE BLADE 17 X 200 MM



L013512
6 X 200 MM

L013513
12 X 200 MM

L013515
20 X 200 MM

L013516
25 X 220 MM

L013517
25 X 250 MM

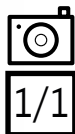

LAME LARDENNOIS 30 X 50 X 360 MM MALLEABLE

L013520 LARDENNOIS MALLEABLE
BLADE 30 X 50 X 360 MM



L013518
25 X 40 X 240 MM

L013519
25 X 40 X 270 MM

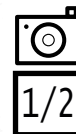

LAME MALLEABLE

MALLEABLE BLADE

LAME POIRIER
 18 X 25 X 200 MM MALLEABLE
L013521 MALLEABLE BLADE POIRIER
 18 X 25 X 200 MM

LAME 30 X 245 X 410 MM MALLEABLE SUR MANCHE
L013523 MALLEABLE BLADE 30 X 245 X 410 MM
 ON HANDLE

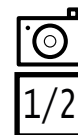
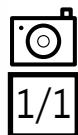

L013524
 40 X 245 X 410 MM

L013525
 50 X 245 X 410 MM

LEVIER

www.in-surg.fr



LEVER

LEVIER BANKART PR TETE HUMERALE

L023526 *BANKART LEVER FOR HUMERAL HEAD*





SOMMAIRE

MAILLET	707
<i>MALLET</i>	
MAIN DE TUPPERS	713
<i>TUPPERS HAND</i>	
MAMOSTAT	714
<i>MAMOSTAT</i>	
MANDRIN	716
<i>MANDREL</i>	
MARTEAU	718
<i>HAMMER</i>	
MASSE	721
<i>MASSEA</i>	
MIROIR	722
<i>MIRROR</i>	



M

RETRO 'SPECTIVE

Charles Horace MAYO
(19 juillet 1865 - 26 mai 1939)

créa avec son père et son frère la **Mayo Clinic** en 1889. Charles Mayo se spécialisa dans la **chirurgie de la thyroïde et du système nerveux**. Il fut aussi responsable de l'**unité d'hospitalisation d'ophtalmologie** à partir de 1908 et fut **un des premiers utilisateurs des rayons X** comme outil de diagnostic.

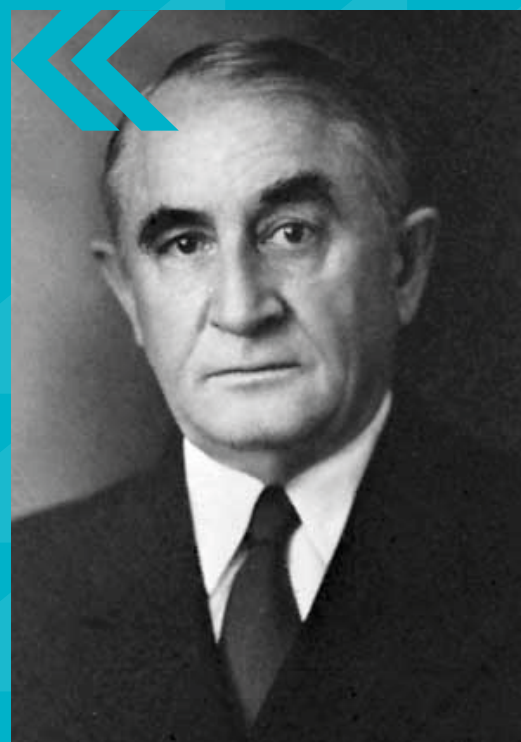

MAILLET

MALLET



MAILLET DIAM 42 / 30 x 240 MM 400 GRAMMES
M013527 MALLET DIAM 42 / 30 X 240 MM 400 GR

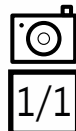

MAILLET DIAM 25 x 180 MM TETE INTERCHANGEABLE 140 GRAMMES

M013528 *DIAM 25 x 180 MM INTERCHANGEABLE HEAD 140 GR*

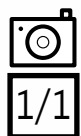

2 TETES DE RECHANGE PR MAILLET M013528

M013529 *2 SPARE HEADS PR MAILLET M013528*



MAILLET

MAILLET

MAILLET BERGMANN
30 X 230 MM 300 GR

M013531 BERGMANN MALLET
30 MM X 230 MM 300 GR

MAILLET COTTLE 190 MM
240 GRAMMES DIAM 30MM

M013532 COTTLE MALLET 190 MM
240 GR DIAM 30 MM

MAILLET HAJEK 28 X 215 MM
140 GRAMMES

M013533 HAJEK MALLET
28 X 215 MM 140 GR

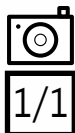
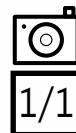
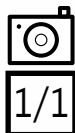

MAILLET HARTPRESS DIAM 42 x 250 MM MANCHE CELERON
M013535 HARTPRESS MALLET DIAM 42 X 250 MM CELERON HANDLE

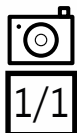

MAILLET HEATH 185 MM 700 GRAMMES
M013537 HEATH MALLET 185 MM 700 GR



MAILLET

MALLET

MAILLET LOMBARD
200 MM 350 GRAMMES

M013539 LOMBARD MALLET 200 MM
350 GR

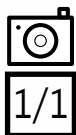

MAILLET MANCHE SOFT GRIP 35 X 230 MM 700GR. COMPLET

M013554 MALLET SOFT GRIP HANDLE 35 X 230 MM 700 GR
COMPLETE

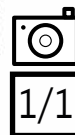

MAILLET MAC EVEN 30 X 230 MM
TETE SIMPLE

M013546 MAC EVEN Mallet 30
X 230 MM SINGLE HEAD



M013545
25 X 230 MM

M013547
35 X 230 MM

M013548
40 X 230 MM

Ø 30 mm



INSURC

M013546 CE



UNTERKUNFT GARANTIE 2027



1/1

MAILLET MAC EVEN 30 X 230 MM
TETE DOUBLE

M013541 MAC EVEN Mallet 30
X 230 MM DOUBLE HEAD



M013540
25 X 230 MM

M013542
35 X 230 MM

M013543
40 X 230 MM

M013544
45 X 230 MM

Ø 30 mm



INSURC

M013541 CE



UNTERKUNFT GARANTIE 2027



1/1

MAILLET SEGURA 150
GRAMMES TETE SIMPLE

M013557 SEGURA Mallet
150 GR SINGLE
HEAD



1/1

MAIN TUPPERS COMPLETE SANS BOITE

M023558 TUPPERS HAND COMPLETE WITHOUT BOX

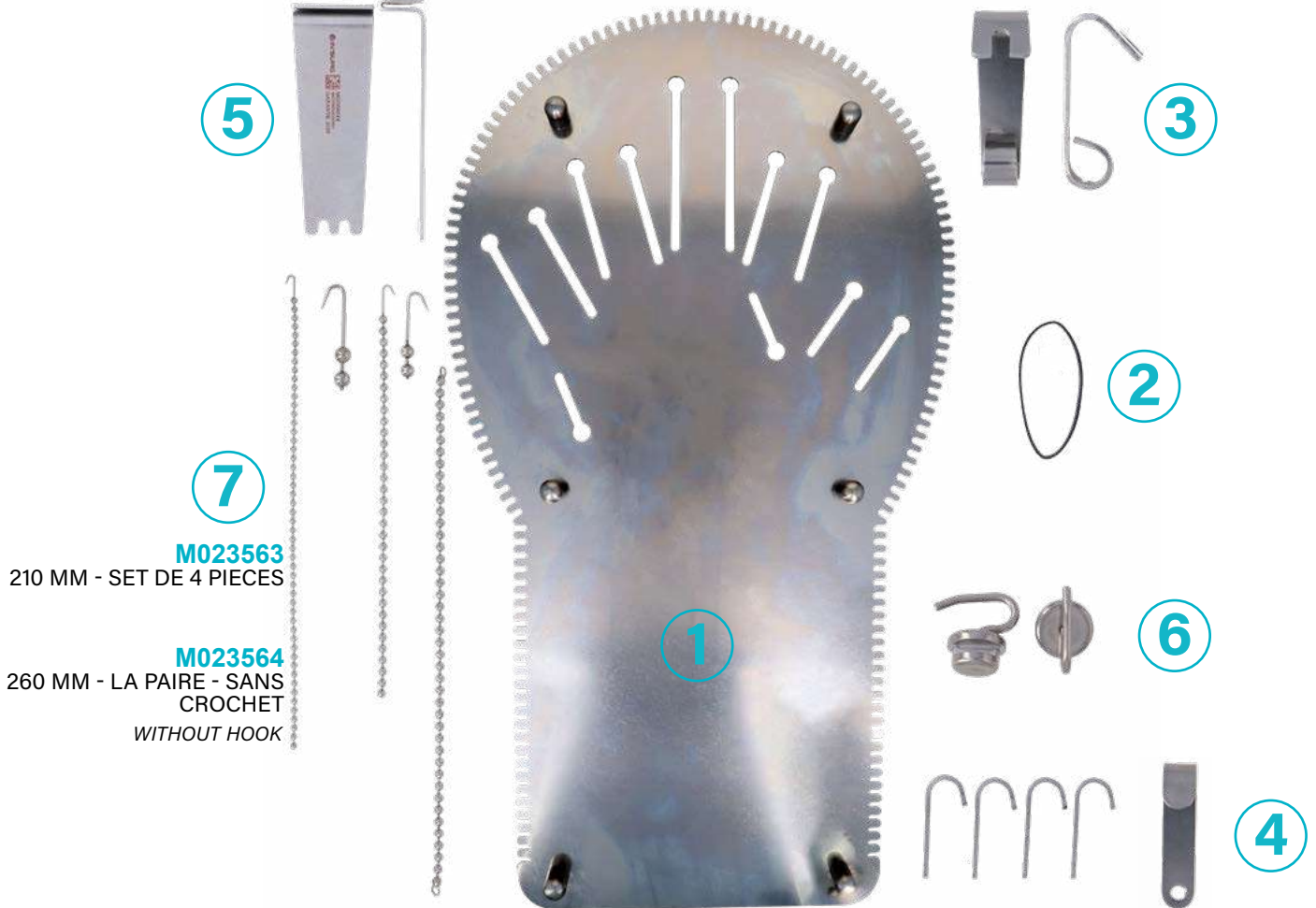

M023563
210 MM - SET DE 4 PIECES

M023564
260 MM - LA PAIRE - SANS
CROCHET
WITHOUT HOOK

- | | | | |
|----------|----------------|---|--|
| 1 | M023559 | MAIN DE TUPPERS SEULE | TUPPERS HAND ONLY |
| 2 | M023567 | ELASTIQUE POUR MAIN DE TUPPERS SET DE 5 PIECES | ELASTIC FOR HAND TUPPERS SET OF 5 PIECES |
| 3 | M023561 | PORTE CROCHET POUR MAIN DE TUPPERS LA PAIRE | HOOK HOLDER FOR HAND OF TUPPERS THE PAIR |
| 4 | M023565 | CROCHET A TENDON POUR MAIN DE TUPPERS SET DE 4 PIECES | TENDON HOOK SUPPORT FOR TUPPERS HAND SET OF 4 |
| 5 | M023560 | PORTE CHAINE POUR MAIN DE TUPPERS LA PAIRE | CHAIN HOLDER FOR TUPPERS HAND THE PAIR |
| 6 | M023566 | SUPPORT POUR ELASTIQUE POUR MAIN DE TUPPERS SET DE 4 PIECES | SUPPORT FOR ELASTIC FOR HAND OF TUPPERS SET OF 4 PIECES |
| 7 | M023562 | CHAINE A BOULES AVEC CROCHETS A PEAU 320 MM POUR MAIN DE TUPPERS LA PAIRE | BALL CHAIN WITH SKIN HOOKS 320 MM FOR HAND OF TUPPERS THE PAIR |

MAMOSTAT

MAMOSTAT INOX AVEC CHAINETTE

M043562 STAINLESS STEEL MAMOSTAT WITH CHAINETTE



MAMOSTAT INOX AVEC CREMAILLERE

M043563 STAINLESS STEEL MAMOSTAT WITH RATCHET



MANDREL

MANDRIN POUR SONDE
FREUDENBERG 46 CM

M053564 MANDREL FOR FREUDENBERG
PROBE 46 CM

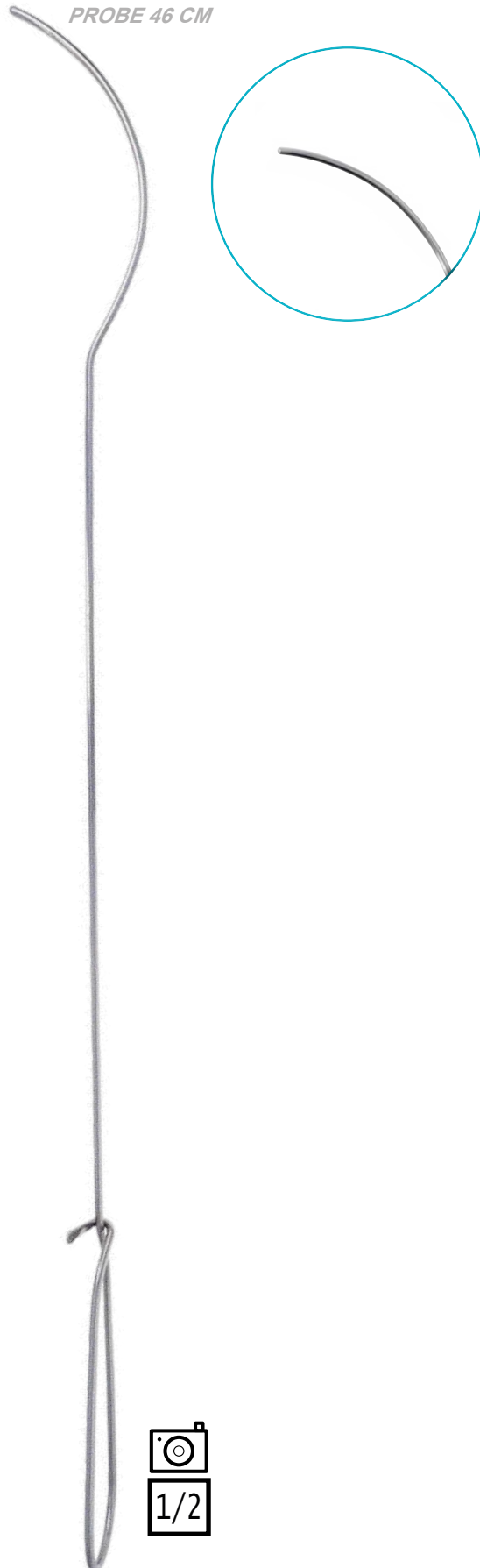

MANDRIN GUYON PR SONDE
CAOUTCHOUC COURBE

M053565 GUYON MANDREL FOR
CAOUTCHOUC PROBES CURVED

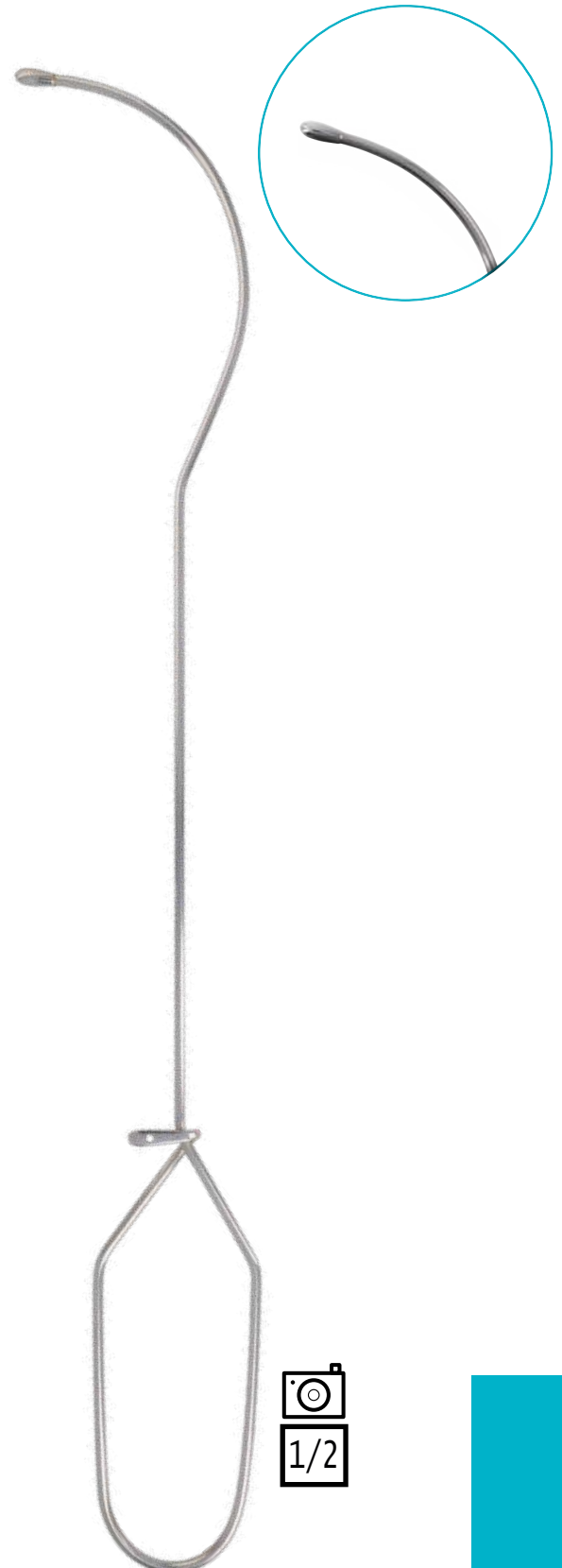

MANDRIN UNIVERSEL DIAM MAX 5 MM INOX AVEC CLE POIGNEE EN T
M053566 *UNIVERSAL MANDREL DIAM MAX 5 MM WITH KEY T HANDLE FORM*



CLE EN T PR MANDRIN UNIVERSEL INOX L'UNITE
M053569 *KEY T FORM FOR UNIVERSAL MANDREL STAINLESS STEEL UNIT*



HAMMER

MARTEAU BABINSKY A REFLEXES ADULTE

M063570 *BABINSKY REFLEX HAMMER ADULT*

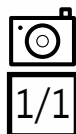

MARTEAU CINTREUR ROCHER/ENDER
M063571 ROCHER/ENDER BENDER HAMMER

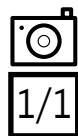

MARTEAU JUDET 1000 GRAMMES

M063573 JUDET HAMMER 1000 GR



M063572
800 GRAMMES

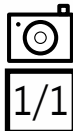

MASSE OMBREDANNE DIAM 30 x 230 MM 500 GRAMMES

M073574 OMBREDANNE MASSEA DIAM 30 X 230 MM 500 GR



M073574

M073575

M073576

M073577

LONGUEUR
LENGTH

DIMENSIONS
SIZE

POIDS
WEIGHT

230 MM

30 MM

500 GR

230 MM

35 MM

700 GR

230 MM

40 MM

900 GR

230 MM

45 MM

1200 GR

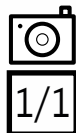

MIRROR

MIROIR LARYNGIEN FIGURE 3

M103583 LARYNGEAL MIRROR FIGURE 3

MANCHE A VIS POUR MIROIR LARYNGIEN

M103590 SCREWED HANDLE FOR LARYNGEAL MIRROR



	FIGURE FIGURE	DIAMETRE DIAMETER
M103589	FIGURE 00	8 MM
M103580	FIGURE 0	10 MM
M103581	FIGURE 1	12 MM
M103582	FIGURE 2	14 MM
M103583	FIGURE 3	16 MM
M103584	FIGURE 4	18 MM
M103585	FIGURE 5	20 MM
M103586	FIGURE 6	22 MM
M103587	FIGURE 7	24 MM
M103588	FIGURE 8	26 MM



SOMMAIRE

OUVRE BOUCHE 725
MOUTH GAGS



RETRO 'SPECTIVE

Louis OMBRÉDANNE
(5 mars 1871 - 4 novembre 1956)

était un **anatomiste et chirurgien** français, spécialisé dans la **chirurgie plastique et la chirurgie pédiatrique**. Il créa le **premier prototype d'appareil inhalateur anesthésique** avec un dispositif de sécurité. En 1929 il donna **une description de l'hyperthermie maligne**, une maladie pharmacogénétique du muscle.





OUVRE BOUCHE DAVIS BOYLE COMPLET AVEC 5 SPATULES

0013602 DAVIS BOYLE MOUTH GAGS COMPLETE WITH 5 SPATULAS



- 1** 0013594 CADRE POUR OUVRE BOUCHE DAVIS BOYLE A GAUCHE L'UNITE *FRAME FOR DAVIS BOYLE MOUTH GAGS LEFT OPENING UNIT*
- 2** 0013595 ABAISSE LANGUE PR OUVRE BOUCHE DAVIS BOYLE 21 x 26 MM SANS ASPIRATION *TONGUE DEPRESSOR FOR DAVIS BOYLE MOUTH GAGS 21 X 26 MM WITHOUT SUCTION*
- 3** 0013596 ABAISSE LANGUE PR OUVRE BOUCHE DAVIS BOYLE 23 x 65 MM *TONGUE DEPRESSOR FOR DAVIS BOYLE MOUTH GAGS 23 X 65 MM*
- 4** 0013597 ABAISSE LANGUE PR OUVRE BOUCHE DAVIS BOYLE 24 x 80 MM *TONGUE DEPRESSOR FOR DAVIS BOYLE MOUTH GAGS 24 X 80 MM*
- 5** 0013598 ABAISSE LANGUE PR OUVRE BOUCHE DAVIS BOYLE 25 x 93 MM *TONGUE DEPRESSOR FOR DAVIS BOYLE MOUTH GAGS 25 X 93 MM*
- 6** 0013599 ABAISSE LANGUE PR OUVRE BOUCHE DAVIS BOYLE 26 x 108 MM *TONGUE DEPRESSOR FOR DAVIS BOYLE MOUTH GAGS 26 X 108 MM*
- 0013600 ABAISSE LANGUE PR OUVRE BOUCHE DAVIS BOYLE 24 x 80 MM SANS ASPIRATION *TONGUE DEPRESSOR FOR DAVIS BOYLE MOUTH GAGS 24 X 80 MM WITHOUT SUCTION*
- 0013601 ABAISSE LANGUE PR OUVRE BOUCHE DAVIS BOYLE 25 x 93 MM SANS ASPIRATION *TONGUE DEPRESSOR FOR DAVIS BOYLE MOUTH GAGS 25 X 93 MM WITHOUT SUCTION*



OUVRE BOUCHE DINGMANN COMPLET AVEC 3 ABAISSES LANGUE

0013610 DINGMANN MOUTH GAGS COMPLETE WITH 3 TONGUE DEPRESSOR

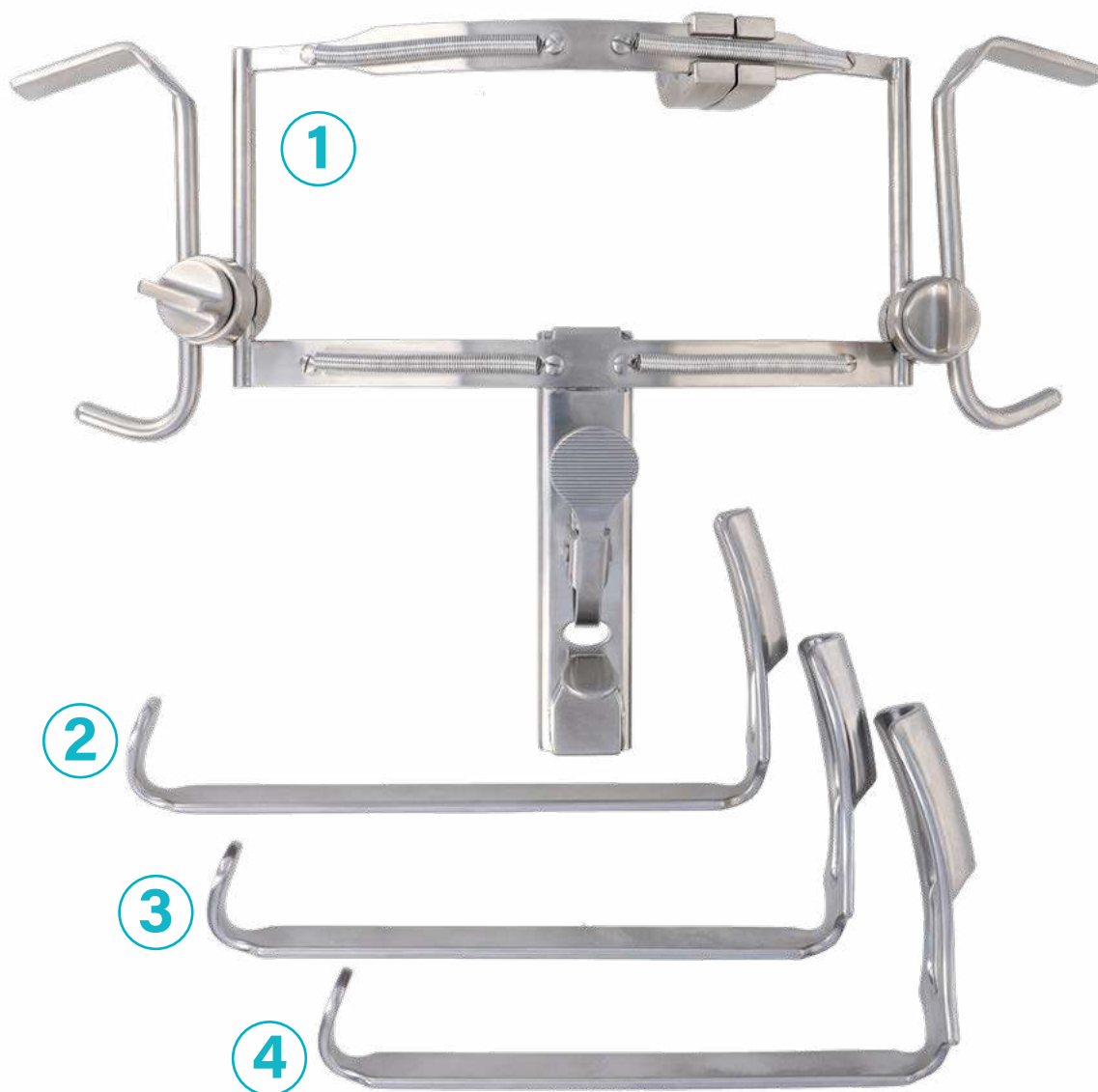

- | | | |
|----------|---|--|
| 1 | 0013609 CADRE PR OUVRE BOUCHE DINGMANN L'UNITE | <i>FRAME FOR DINGMANN MOUTH GAGS UNIT</i> |
| 2 | 0013606 ABAISSE LANGUE PR OUVRE BOUCHE DINGMANN 24 x 62 MM | <i>TONGUE DEPRESSOR FOR DINGMANN MOUTH GAGS 24 X 62 MM</i> |
| 3 | 0013607 ABAISSE LANGUE PR OUVRE BOUCHE DINGMANN 28 x 65 MM | <i>TONGUE DEPRESSOR FOR DINGMANN MOUTH GAGS 28 X 65 MM</i> |
| 4 | 0013608 ABAISSE LANGUE PR OUVRE BOUCHE DINGMANN 31 x 75 MM | <i>TONGUE DEPRESSOR FOR DINGMANN MOUTH GAGS 31 X 75 MM</i> |



OUVRE BOUCHE

MOUTH GAGS

OUVRE BOUCHE JENNINGS 80 MM

O013613 JENNINGS MOUTH GAGS 80 MM

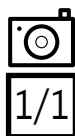

O013614
110 MM

O013615
130 MM

O013616
150 MM

OUVRE BOUCHE DOYEN 150 MM AVEC 2 PROTECTIONS SILICONES PR ADULTE

O013611 DOYEN MOUTH GAGS 150 MM WITH 2 PROTECTORS SILICONES FOR ADULT

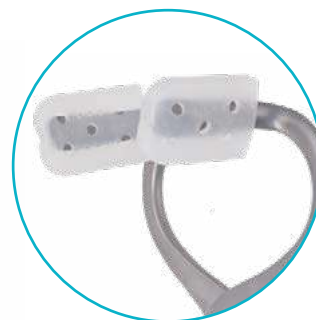

O013612
120 MM - ENFANT
CHILDREN

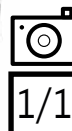



OUVRE BOUCHE KILNER DOUGHTY COMPLET

0013621 KILNER DOUGHTY MOUTH GAGS COMPLETE



- | | | | |
|-----------------|-----------------------|--|--|
| <p>1</p> | <p>0013620</p> | <p>CADRE PR OUVRE BOUCHE KILNER DOUGHTY L'UNITE</p> | <p>FRAME FOR KILNER DOUGHTY MOUTH GAGS UNIT</p> |
| <p>2</p> | <p>0013617</p> | <p>ABASSE LANGUE PR OUVRE BOUCHE KILNER DOUGHTY 28 x 65 MM</p> | <p>TONGUE DEPRESSOR FOR KILNER DOUGHTY MOUTH GAGS 28 X 65 MM</p> |
| <p>3</p> | <p>0013618</p> | <p>ABASSE LANGUE PR OUVRE BOUCHE KILNER DOUGHTY 32 x 75 MM</p> | <p>TONGUE DEPRESSOR FOR KILNER DOUGHTY MOUTH GAGS 32 X 75 MM</p> |
| <p>4</p> | <p>0013619</p> | <p>ABASSE LANGUE PR OUVRE BOUCHE KILNER DOUGHTY 37 x 80 MM</p> | <p>TONGUE DEPRESSOR FOR KILNER DOUGHTY MOUTH GAGS 37 X 80 MM</p> |

OUVRE BOUCHE MOLT 150 MM ADULTE

0013625 MOLT MOUTH GAGS 150 MM ADULT



0013626
100 MM - ENFANT
CHILDREN

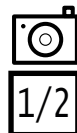

SOMMAIRE

PASSE FILS731 <i>WIRE GUIDE</i>	PINCE GYNECO893 <i>GYNECO FORCEPS</i>
PEIGNE744 <i>COMB</i>	PINCE HEMOSTATIQUE915 <i>HEMOSTATIC FORCEPS</i>
PERFORATEUR745 <i>HAND HELD JACKHAMMER</i>	PINCE MENISQUE957 <i>MENISCUS FORCEPS</i>
PINCE A COURBER / TORSADER749 <i>BEND / TWIST FORCEPS</i>	PINCE NEURO MICRO960 <i>MICRO NEURO FORCEPS</i>
PINCE A BIOPSIE GYNECO750 <i>GYNECO BIOPSY FORCEPS</i>	PINCE ONGLES961 <i>NAILS FORCEPS</i>
PINCE A CALCULS760 <i>GALL STONE FORCEPS</i>	
PINCE CHAMPS764 <i>TOWEL CLAMPS</i>	PINCE ORL :
PINCE A COAGULATION770 <i>COAGULATION FORCEPS</i>	AMYGDALES962 <i>ENT FORCEPS - TONSIL</i>
	OTOLOGIE964 <i>ENT FORCEPS - OTOLOGY</i>
PINCE COUPANTE :	RHINOLOGIE968 <i>ENT FORCEPS - RHINOLOGY</i>
DOUBLE ARTICULATION783 <i>CUTTING PLIERS DOUBLE ARTICULATION</i>	TIRE LANGUE976 <i>ENT FORCEPS - TONGUE HOLDING FORCEPS</i>
SIMPLE ARTICULATION788 <i>CUTTING PLIERS SINGLE ARTICULATION</i>	
PINCE A DISSEQUER795 <i>DISSECTING FORCEPS</i>	PINCE PANSEMENT977 <i>DRESSING FORCEPS</i>
	PINCE PERFORANTE987 <i>PERFORATING FORCEPS</i>
PINCE DIVERSE :	PINCE PLATRE988 <i>PLASTER CAST BREAKER FORCEPS</i>
(A DRAINS)839 <i>VARIOUS FORCEPS (EMPTY THE DRAIN)</i>	PINCE PREHENSION991 <i>GRASPING FORCEPS</i>
(INTUBATION)840 <i>VARIOUS FORCEPS (INTUBATION)</i>	PINCE PRESSE TUBE1004 <i>TUBING CLAMPS</i>
(PROTEGE CUECUM)841 <i>VARIOUS FORCEPS (PROTECT CUECUM)</i>	PINCE PROSTATIQUE1006 <i>PROSTATIC FORCEPS</i>
PINCE A ECHARDES842 <i>SPLINTER FORCEPS</i>	PINCE TENDONS1007 <i>TENDONS FORCEPS</i>
PINCE A EPILER844 <i>TWEEZER</i>	POIGNEE1009 <i>HANDLE</i>
PINCE COUPE FILS845 <i>WIRE CUTTING PLIERS</i>	POINTE BANKART1010 <i>BANKART TIP</i>
PINCE FILS EXTRACTION852 <i>WIRE EXTRACTION PLIERS</i>	POINTE CARREE1011 <i>DRILL SQUARE</i>
PINCE FILS PREHENSION857 <i>WIRE PREHENSION PLIERS</i>	PORTE AIGUILLE1016 <i>NEEDLE HOLDER</i>
	PORTE AIGUILLE MICRO1045 <i>NEEDLE HOLDER</i>
PINCE GOUGE :	PORTE COTON1061 <i>COTON APPLICATOR</i>
DOUBLE ARTICULATION860 <i>BONE RONGEUR DOUBLE ARTICULATION</i>	PORTE VIS1063 <i>SCREW HOLDER</i>
SIMPLE ARTICULATION875 <i>BONE RONGEUR SINGLE ARTICULATION</i>	PROTECTEUR SILICONE1064 <i>SILICONE PROTECTION</i>



P

RETRO 'SPECTIVE

Jules Émile PÉAN
(29 novembre 1830 - 30 janvier 1898)

était un **chirurgien** français, **inventeur de la pince hémostatique et de la valve Péan**. Il est aussi le premier à réussir une **splénectomie et l'ablation du kyste de l'ovaire**.

Il invente avec son collègue **l'opération de Pean-Segond** et une autre qui porte uniquement son nom consistant à effectuer une gastrectomie.

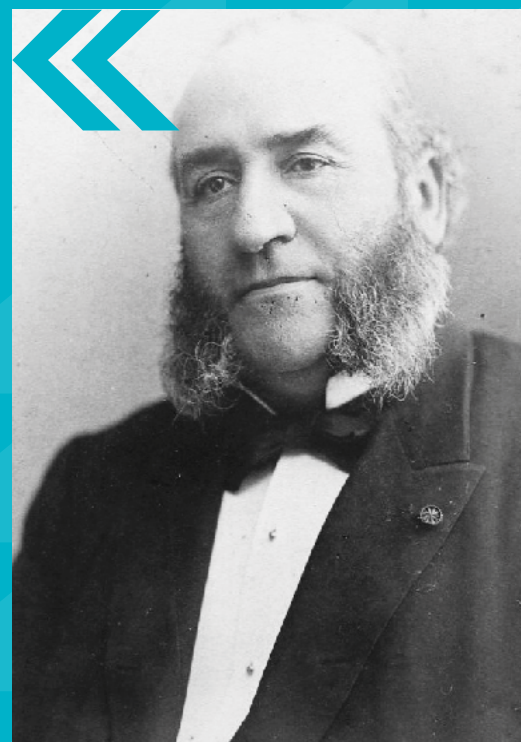

PASSE FILS TUBULAIRE DANIS 210 MM SUR MANCHE
P013633 *DANIS WIRE GUIDE TUBULAR 210 MM ON HANDLE*

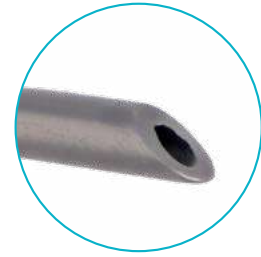

P013633
210 MM



P013632
190 MM

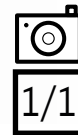

P013631
175 MM



PASSE FILS FINOCHIETTO 240 MM COUDE A 90°
P013635 FINOCHIETTO WIRE GUIDE 240 MM ANGLED 90°



PASSE FILS HARRINGTON 300 MM
P013636 HARRINGTON WIRE GUIDE 300 MM



PASSE FILS

WIRE GUIDE

PASSE FILS LAWRENCE 280 MM
P013637 LAWRENCE WIRE GUIDE 280 MM

PASSE FILS MEEKER 280 MM
P013638 MEEKER WIRE GUIDE 280 MM



PASSE FILS MIXTER 220 MM

P013639 MIXTER WIRE GUIDE 220 MM

PASSE FILS MIXTER 230 MM

P013640 MIXTER WIRE GUIDE 230 MM

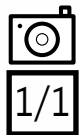

P013641
250 MM

P013642
280 MM



PASSE FILS

WIRE GUIDE

PASSE FILS OSHAUGNESSY
300 MM COUDE A 90° TRES FIN

P013710 OSHAUGNESSY WIRE GUIDE 300 MM
ANGLED 90° VERY BENT

PASSE FILS OSHAUGNESSY 225 MM FIN EN S
ULTRA LINE

P013643 ULTRA LINE OSHAUGNESSY WIRE
GUIDE 225 MM BENT S FORM



PASSE FILS OSHAUGNESSY 120 MM COUDE A 45° FIN

P013644 OSHAUGNESSY WIRE GUIDE 120 MM ANGLED 45° BENT

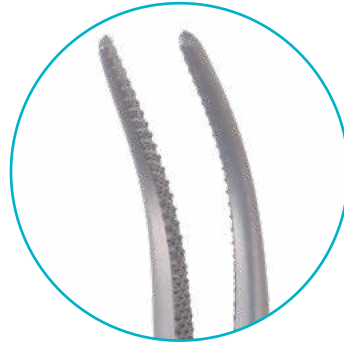

PASSE FILS FIN
WIRE GUIDE BENT



COUDE A 45°
ANGLED 45°

COUDE A 90°
ANGLED 90°

LONGUEUR
LENGTH

120 MM

P013644

P013645

140 MM

P013646

P013648

180 MM

P013650

P013652

200 MM

P013654

P013656

220 MM

P013658

P013659

240 MM

P013660

P013662

300 MM

P013664

P013667

PASSE FILS OSHAUGNESSY 140 MM COUDE A 45° FIN ULTRA LINE

P013647 *ULTRA LINE OSHAUGNESSY WIRE GUIDE 140 MM ANGLED 45° BENT*



PASSE FILS FIN
WIRE GUIDE BENT



LONGUEUR
LENGTH

COUDE A 45°
ANGLED 45°

COUDE A 90°
ANGLED 90°

140 MM

P013647

P013649

180 MM

P013651

P013653

200 MM

P013655

P013657

240 MM

P013661

P013663

300 MM

P013665

P013668

PASSE FILS OSHAUGNESSY 200 MM COUDE A 45° FORT

P013669 OSHAUGNESSY WIRE GUIDE 200 MM ANGLED 45° STRONG

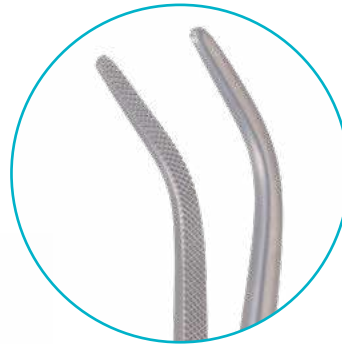

PASSE FILS FORT

WIRE GUIDE STRONG



COUDE A 45°
ANGLED 45°



COUDE A 90°
ANGLED 90°



LONGUEUR
LENGTH

- 200 MM
- 220 MM
- 240 MM
- 260 MM
- 300 MM

P013669	P013671
P013673	P013674
P013675	P013677
P013679	P013680
P013681	P013683

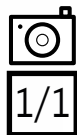

PASSE FILS OSHAUGNESSY 200 MM COUDE A 45° FORT ULTRA LINE

P013670 *ULTRA LINE OSHAUGNESSY WIRE GUIDE 200 MM ANGLED 45° STRONG*



PASSE FILS FORT
WIRE GUIDE STRONG



LONGUEUR
LENGTH

COUDE A 45°
ANGLED 45°

COUDE A 90°
ANGLED 90°

200 MM

P013670

P013672

240 MM

P013678

250 MM

P013676

300 MM

P013682

P013684



PASSE FILS OVERHOLT GEISSENDOERFER 210 MM FIGURE 2
P013687 OVERHOLT GEISSENDOERFER WIRE GUIDE 210 MM FIGURE 2

LONGUEUR
 LENGTH
 210 MM 270 MM

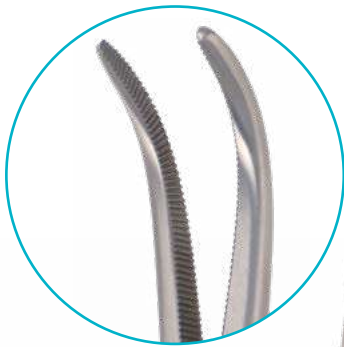

FIGURE 1



FIGURE 2



FIGURE 3



FIGURE 4



FIGURE 5



FIGURE 6



FIGURE 7

P013685 **P013686**

P013687 **P013688**

P013689 **P013690**

P013691 **P013692**

P013693 **P013694**

P013695 **P013696**

P013697 **P013698**



PASSE FILS

WIRE GUIDE

PASSE FILS TRILLAT 310 MM

P013706 TRILLAT WIRE GUIDE 310 MM

PASSE FILS RUMEL 230 MM FIGURE 1

P013699 RUMEL WIRE GUIDE 230 MM FIGURE 1

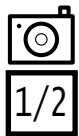

P013700
FIGURE 2

P013701
FIGURE 3

P013702
FIGURE 4

PASSE FILS SEMB 230 MM COURBE

P013704 SEMB WIRE GUIDE 230 MM CURVED

PASSE FILS SEMB 230 MM TRES COURBE

P013705 SEMB WIRE GUIDE 230 MM VERY CURVED

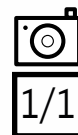
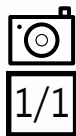

PASSE FILS YASARGIL 185 MM COURBE BOUTONNE SUR MANCHE

P013707 YASARGIL WIRE GUIDE 185 MM CURVED BUTONED ON HANDLE



PASSE FILS YASARGIL 185 MM COUDE A 90° BOUTONNE SUR MANCHE

P013708 YASARGIL WIRE GUIDE 185 MM ANGLED A 90° BUTONED ON HANDLE



PASSE FILS YASARGIL 185 MM TRES COURBE BOUTONNE SUR MANCHE

P013709 YASARGIL WIRE GUIDE 185 MM VERY CURVED BUTONED ON HANDLE

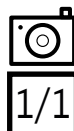
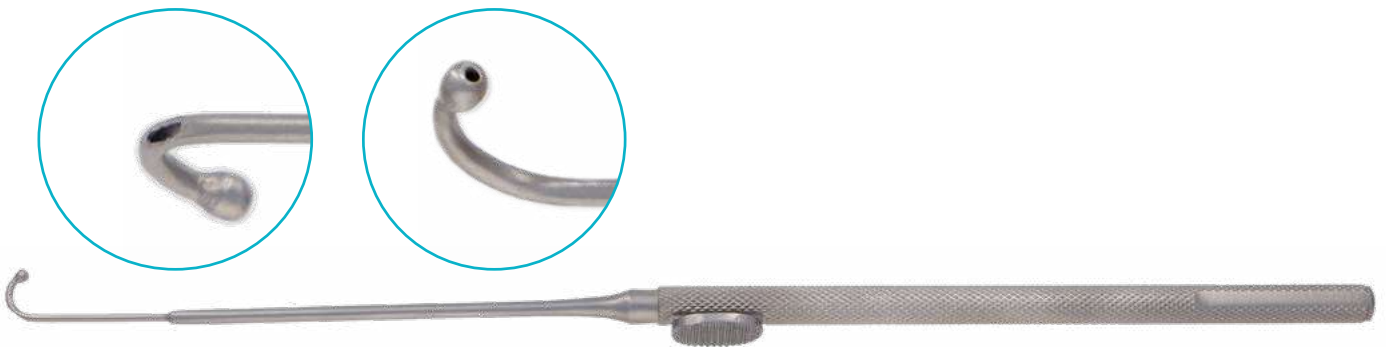

PEIGNE

COMB

PEIGNE JOST POUR PLASTIE

P023710 JOST COMB FOR PLASTIC SURGERY



PERFORATEUR

HAND HELD JACKHAMMER

PERFORATEUR CORTICALE DIAM 8 MM PR TIBIA

P033714 CORTICAL HAND HELD JACKHAMMER DIAM 8 MM FOR TIBIA

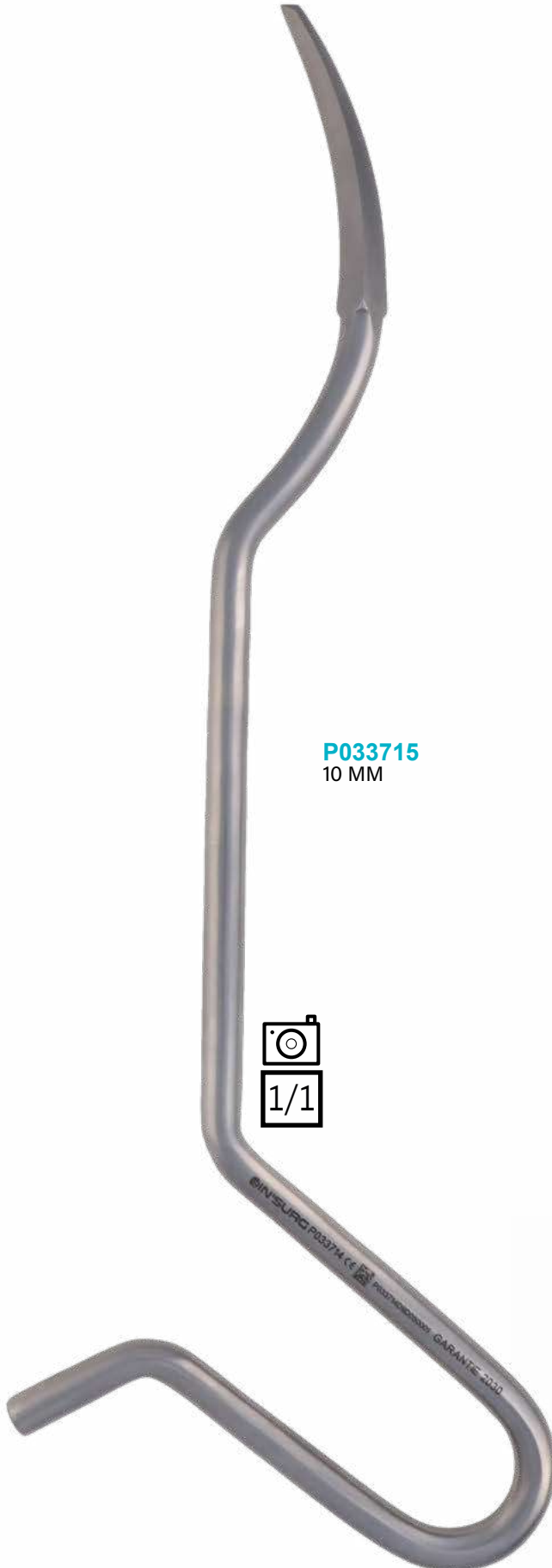

P033715
10 MM

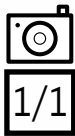

FORET PR PERFORATEUR NELATON 2 MM L'UNITE

P033717 DRILL FOR NELATON HAND HELD JACKHAMMER 2 MM UNIT

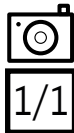
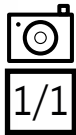

P033717
2 MM



P033718
3 MM



P033719
4 MM

MANCHE PR PERFORATEUR NELATON L'UNITE

P033720 HANDLE FOR NELATON HAND HELD JACKHAMMER UNIT

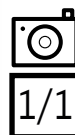

PERFORATEUR

HAND HELD JACKHAMMER

PERFORATEUR RALK 160 MM 3 MACHOIRES OUV. JUSQU'A 6 MM

P033721 RACK HAND HELD JACKHAMMER 160 MM WITH 3 JAWS OPENING MAX 6 MM



PERFORATEUR UNIVERSEL 280 MM 3 MACHOIRES OUV. JUSQU'A 6,3 MM

P033722 UNIVERSAL HAND HELD JACKHAMMER 280 MM WITH 3 JAWS OPENING MAX 6,3 MM



PINCE A COURBER 220 MM PR PLAQUES 2,7 / 3,5 MM

P063733 CURVE FORCEPS FOR PLATES 2,7 / 3,5 MM

PINCE A TORSADER 210 MM TUNGSTENE

P063734 TWISTING FORCEPS 210 MM TUNGSTEN

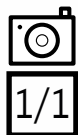

PINCE A BIOPSIE GYNECO

www.in-surg.fr

P

GYNECO BIOPSY FORCEPS



PINCE BIOPSIE GYNECO ALEXANDER 200 MM

P073744 ALEXANDER GYNECO BIOPSY FORCEPS 200 MM



1/1



PINCE BIOPSIE GYNECO BERGER 210 MM

P073745 BERGER GYNECO BIOPSY FORCEPS 210 MM

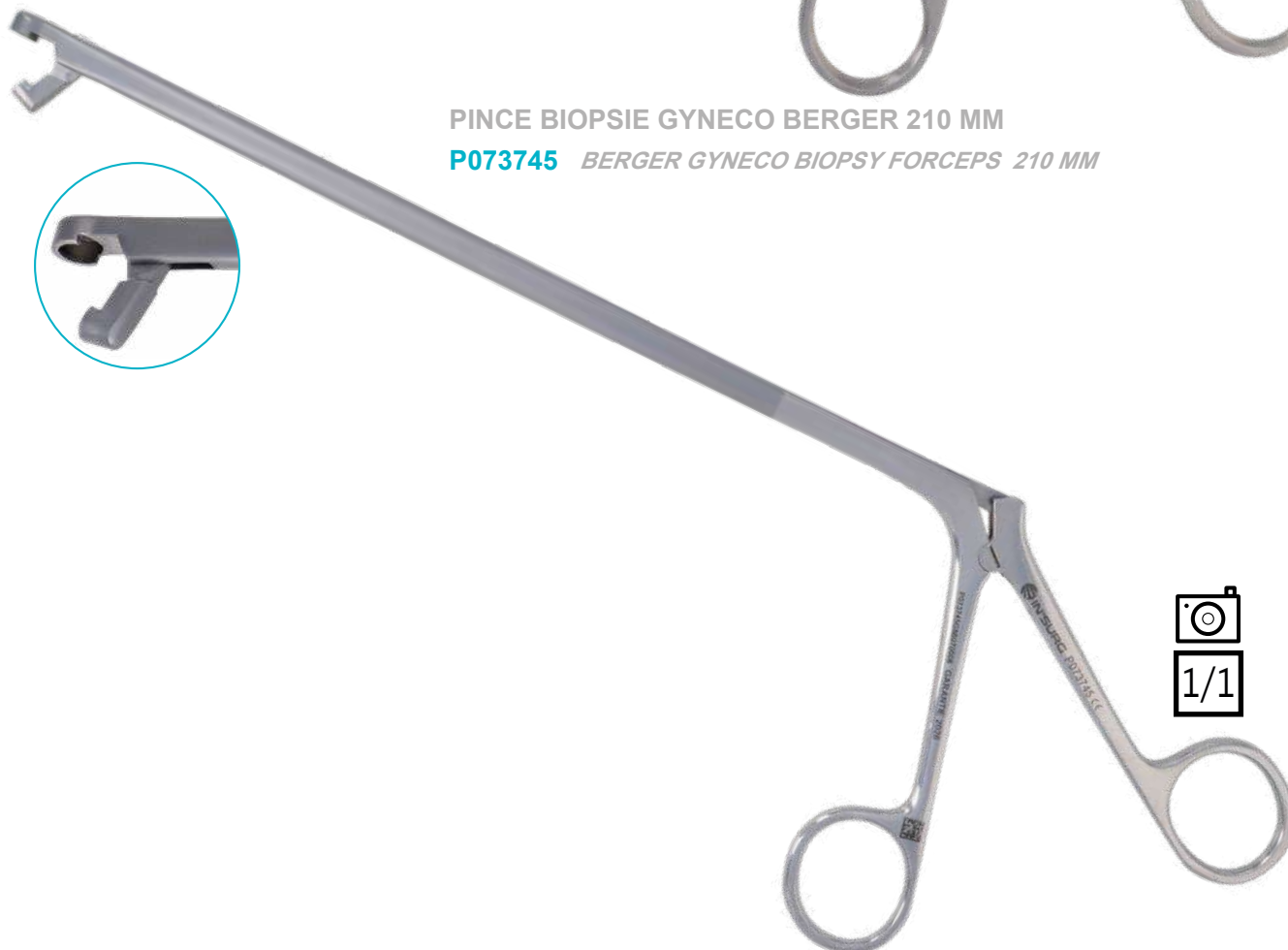

1/1

PINCE A BIOPSIE GYNECO

GYNECO BIOPSY FORCEPS

PINCE BIOPSIE GYNECO DOUAY 200 MM

P073746 DOUAY GYNECO BIOPSY FORCEPS 200 MM

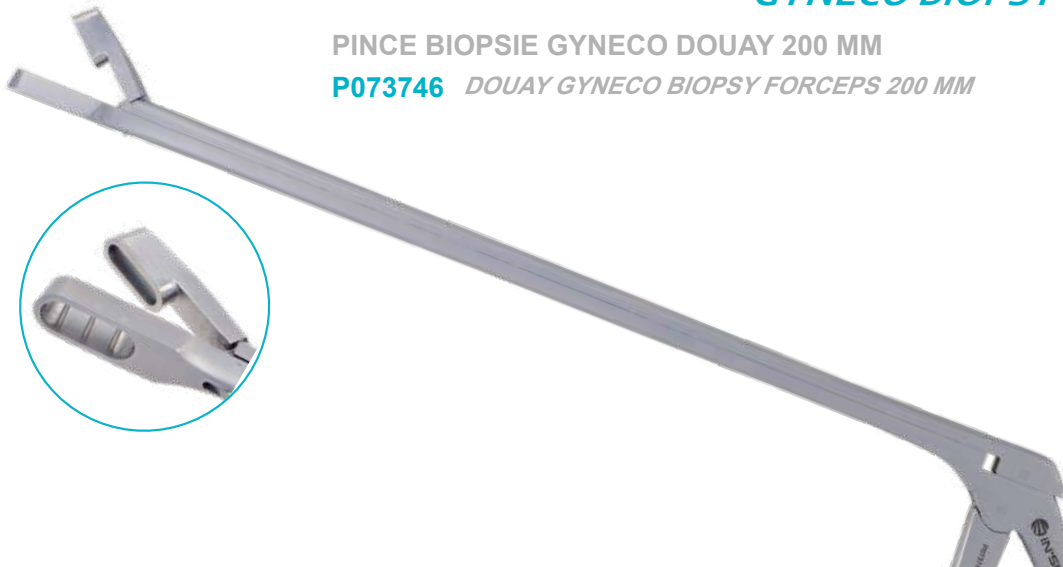

P073747
250 MM

P073748
300 MM

P073749
350 MM

P073750
400 MM



1/1

PINCE BIOPSIE GYNECO JEAN LOUIS FAURE
240 MM

P073754 JEAN LOUIS FAURE GYNECO BIOPSY
FORCEPS 240 MM



1/1

PINCE BIOPSIE GYNECO EPPENDORF 200 MM

P073751 *EPPENDORF GYNECO BIOPSY FORCEPS
200 MM*



PINCE BIOPSIE GYNECO GELLHORN 230 MM

P073753 *GELLHORN GYNECO BIOPSY FORCEPS
230 MM*



PINCE A BIOPSIE GYNECO

GYNECO BIOPSY FORCEPS

PINCE BIOPSIE GYNECO KEVORKIAN 250 MM ROTATION A 360°

P073756 KEVORKIAN GYNECO BIOPSY FORCEPS 250 MM ROTARY 360°



ROTATION À 360°
ROTARY 360°

PINCE BIOPSIE GYNECO SCHUBERT 210 MM DROITE BRANCHES PASSEES
P073758 *SCHUBERT GYNECO BIOPSY FORCEPS 210 MM STRAIGHT WITH HOUSING*



P073759
290 MM

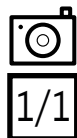

PINCE BIOPSIE GYNECO SCHUMACHER 4 x 240 MM

P073760 SCHUMACHER GYNECO BIOPSY FORCEPS 4 X 240 MM



P073761
6 X 240 MM

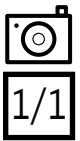

PINCE BIOPSIE GYNECO TISCHLER KEVORKIAN 230 MM
P073765 TISCHLER KEVORKIAN GYNECO BIOPSY FORCEPS 230 MM



PINCE BIOPSIE GYNECO TISCHLER 2 x 200 MM
P073766 TISCHLER GYNECO BIOPSY FORCEPS 2 X 200 MM



P073767
2 X 250 MM

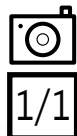

PINCE BIOPSIE GYNECO TISCHLER MORGAN 230 MM

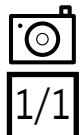
P073768 TISCHLER MORGAN GYNECO BIOPSY FORCEPS 230 MM

PINCE BIOPSIE GYNECO VAN DOREN
275 MM MORS TRIANGULAIRE BRANCHES
PASSEES SANS CREMAILLERE

P073769 VAN DOREN GYNECO BIOPSY FORCEPS
275 MM WITH HOUSING WITHOUT RATCHET



PINCE BIOPSIE GYNECO VAN DOREN 255 MM
MORS ROND BRANCHES PASSEES A
CREMAILLERE

P073770 VAN DOREN GYNECO BIOPSY FORCEPS
255 MM WITH HOUSING WITH RATCHET



PINCE BIOPSIE GYNECO WITTNER 230 MM DROITE

P073772 WITTNER GYNECO BIOPSY FORCEPS 230 MM STRAIGHT

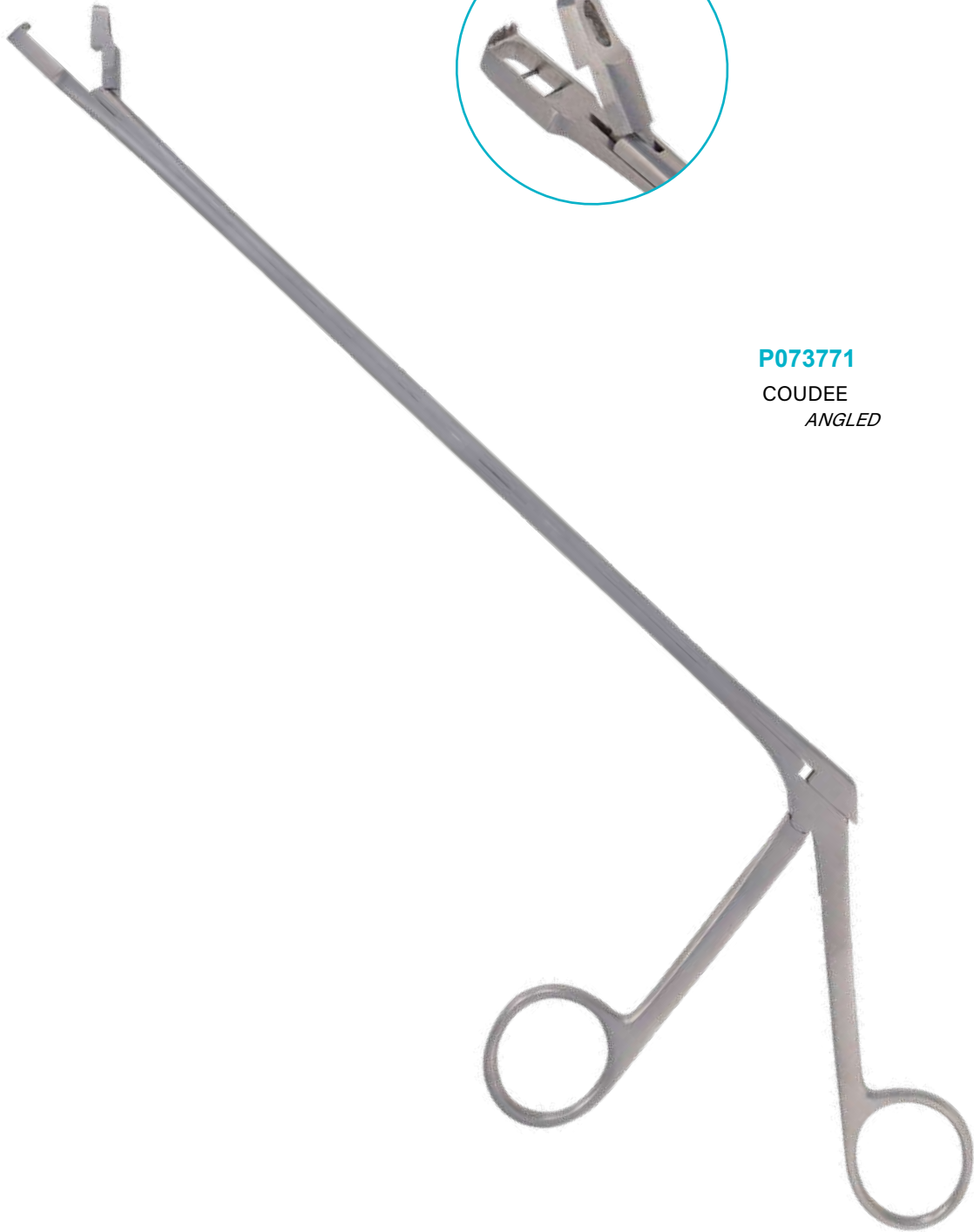

P073771

COUDEE

ANGLED

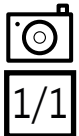

PINCE A CALCULS

www.in-surg.fr

P

GALL STONE FORCEPS

PINCE CALCULS BLACKE 210 MM COURBE

P083787 BLACKE GALL STONE FORCEPS 210 MM CURVED

PINCE CALCULS BLACKE 210 MM DROITE

P083788 BLACKE GALL STONE FORCEPS 210 MM STRAIGHT



PINCE A CALCULS

GALL STONE FORCEPS

PINCE CALCULS DESJARDINS 230 MM
FIGURE 1

P083789 DESJARDINS GALL STONE FORCEPS
230 MM FIGURE 1



FIGURE 1

PINCE CALCULS DESJARDINS 230 MM
FIGURE 2

P083790 DESJARDINS GALL STONE FORCEPS
230 MM FIGURE 2



FIGURE 2

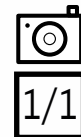
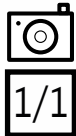

PINCE CALCULS MIRIZZI 230 MM FIGURE 2

P083791 MIRIZZI GALL STONE FORCEPS 230 MM FIGURE 2

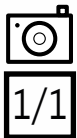

FIGURE 1
P083792



FIGURE 2
P083791



FIGURE 3
P083793



FIGURE 4
P083794



FIGURE 5
P083795



FIGURE 6
P083796



FIGURE 7
P083797



FIGURE 8
P083798



FIGURE 9
P083799

PINCE A CALCULS

GALL STONE FORCEPS

PINCE CALCULS RANDALL 190 MM

P083800 RANDALL GALL STONE FORCEPS 190 MM

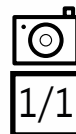

TOWEL CLAMPS

PINCE CHAMPS BACKAUS 90 MM

P113807 BACKAUS TOWEL CLAMPS 90 MM



P113809
120 MM

P113810
140 MM



PINCE CHAMPS BACKAUS ROEDER 130 MM AVEC BOULES

P113808 BACKAUS TOWEL ROEDER CLAMPS 130 MM WITH BALLS

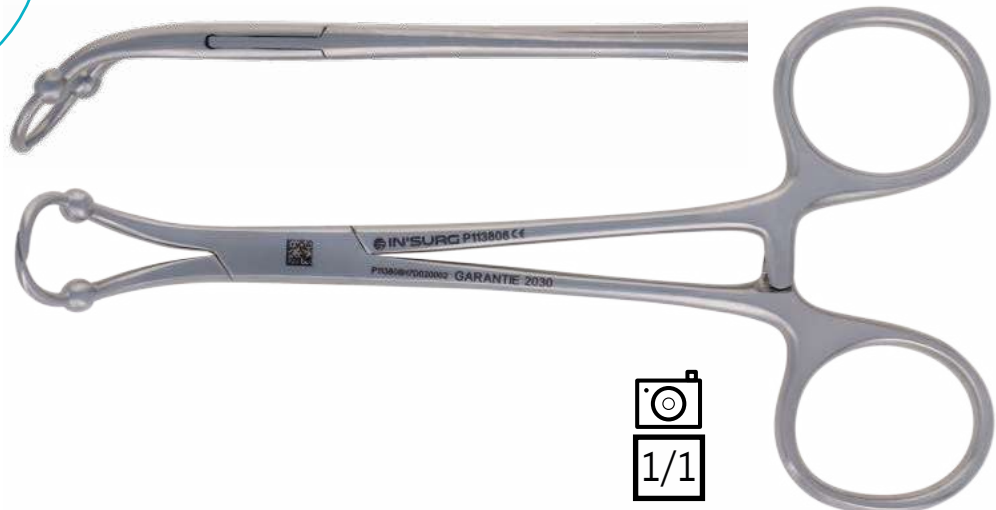

PINCE CHAMPS

TOWEL CLAMPS

PINCE CHAMPS BACKAUS 140 MM PORTE TUBE
P113811 BACKAUS TOWEL CLAMPS 140 MM WITH TUBE HOLDER

PINCE CHAMPS CRABE 90 MM
P113812 CRABE TOWEL CLAMPS 90 MM



PINCE CHAMPS DOYEN 180 MM
P113813 DOYEN TOWEL CLAMPS 180 MM

PINCE CHAMPS JAYLE 130 MM
P113814 JAYLE TOWEL CLAMPS 130 MM

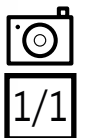
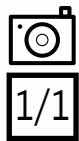

PINCE CHAMPS

TOWEL CLAMPS

PINCE CHAMPS LORNA 140 MM
PR CHAMPS PAPIER

P113815 LORNA TOWEL CLAMPS 140 MM
FOR PAPER OPERATIVE FIELD



PINCE CHAMPS PAUCHET 200 MM TENAILLE
P113816 PAUCHET TOWEL CLAMPS 200 MM
PINCER

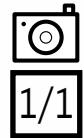

PINCE CHAMPS PEERS 140 MM
PR CHAMPS PAPIER

P113817 PEERS TOWEL CLAMPS 140 MM
FOR PAPER OPERATIVE FIELD

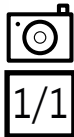

PINCE CHAMPS TISSERAND 140 MM
PR CHAMPS PAPIER

P113818 TISSERAND TOWEL CLAMPS 140 MM
FOR PAPER OPERATIVE FIELD



PINCE CHAMPS

TOWEL CLAMPS

PINCE CHAMPS TOHOKU 120 MM PR CHAMPS PAPIER

P113819 *TOHOKU TOWEL CLAMPS 120 MM FOR PAPER OPERATIVE FIELD*



PINCE A COAGULATION

www.in-surg.fr

P

COAGULATION FORCEPS

CORDON PR PINCE A COAGULATION 3 M FICHE PLATE PR VALLEYLAB - BIPOLAIRE

P123907 *CONNECTING CABLE FOR BIPOLAR COAGULATION FORCEPS 3 M FLAT PLUG FOR VALLEYLAB*



CORDON PR PINCE DOUBLE POINTES A COAGULATION 3 M CONNEXION US TYPE 2 FICHES - BIPOLAIRE

P123911 *CABLE CONNECTING FOR BIPOLAR COAGULATION FORCEPS DOUBLE TIPS 3 M US CONNECTION TYPE 2 PLUGS*



CORDON PR PINCE A COAGULATION 5 M PR VALLEYLAB - BIPOLAIRE

P123930 *CONNECTING CABLE FOR BIPOLAR COAGULATION FORCEPS 5 M FOR VALLEYLAB*



PINCE A COAGULATION 0,7 X 1,5 X 190 MM DROITE MONOPOLAIRE

P123902 *MONOPOLAR COAGULATION FORCEPS 0.7 X 1.5 X 190 MM STRAIGHT*

PINCE A COAGULATION 1,0 X 2,0 X 230 MM COUDEE MONOPOLAIRE

P123904 *MONOPOLAR COAGULATION FORCEPS 1,0 X 2,0 X 230 MM ANGLED*



P123903
1.0 X 2.0 X 230 MM

MONOPOLAIRE
MONOPOLAR



PINCE A COAGULATION 1,0 X 2,0 X 230 MM
DROITE BAIONNETTE MONOPOLAIRE

P123905 *MONOPOLAR COAGULATION FORCEPS
1,0 X 2,0 X 230 MM ANGLED BAYONET*

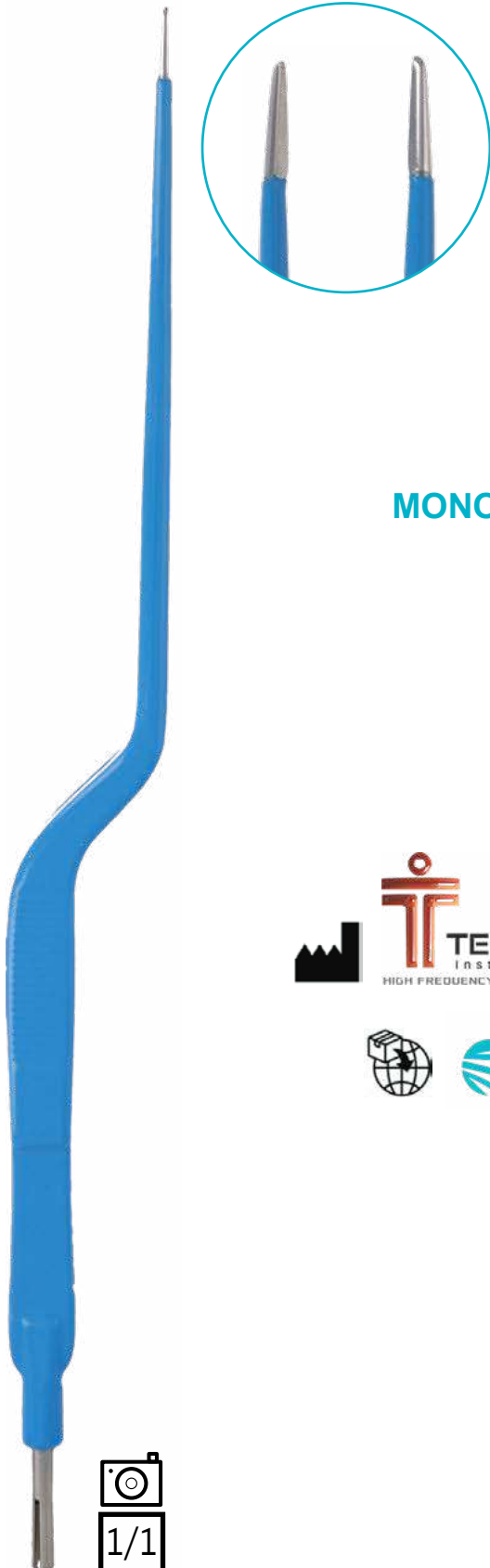

POINTE 0,1 X 180 MM DROITE POINTUE
MONOPOLAIRE

P123906 *MONOPOLAR TIP 0,1 X 180 MM
STRAIGHT SHARP*



MONOPOLAIRE
MONOPOLAR

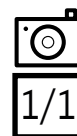
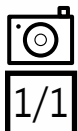

MONOPOLAIRE
MONOPOLAR

PINCE A DISSEQUER ADSON 1,2 x 130 MM A CONTACTEUR MONOPOLAIR

P123925 ADSON MONOPOLAR COAGULATION FORCEPS 1,2 X 130 MM



BIPOLAIRE
BIPOLAR

PINCE A COAGULATION TYPE GERALD 1 X 180 MM
BAIONNETTE DROITE MOUSSE BIPOLAIRE

P123909 BIPOLAR COAGULATION FORCEPS
GERALD TYPE 1 X 180 MM BAYONET
BLUNT

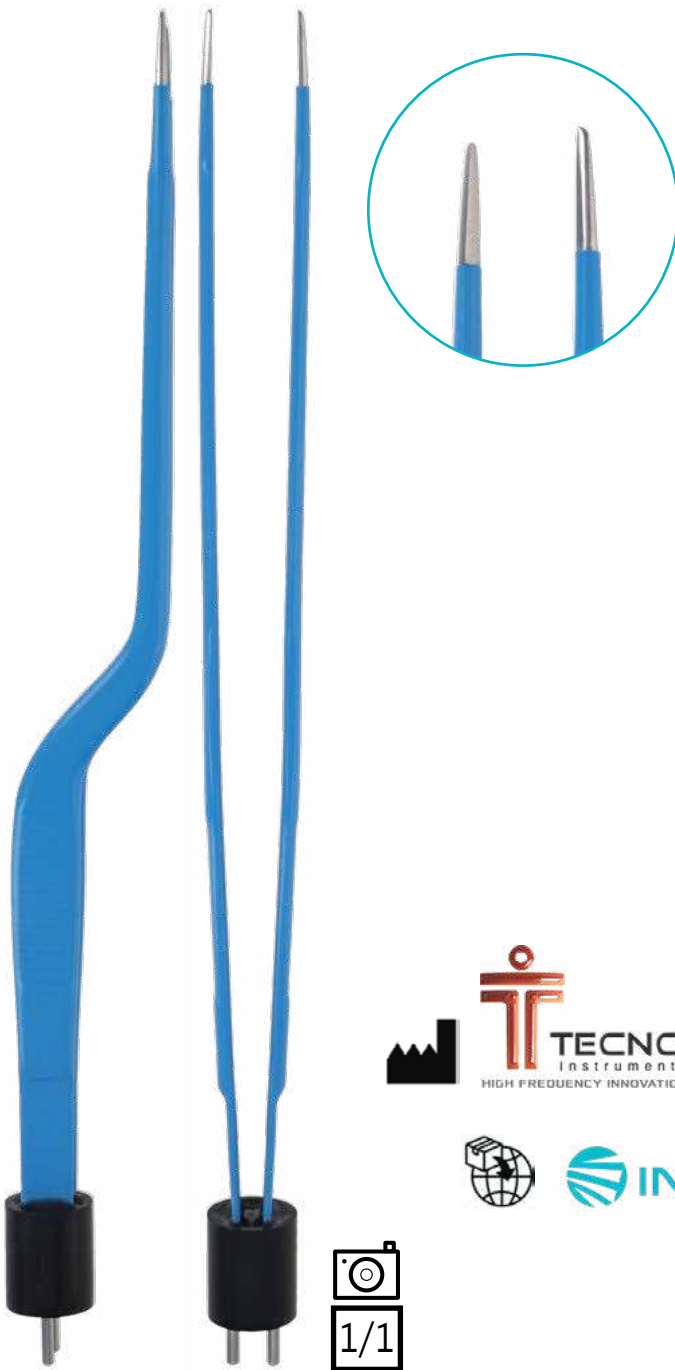

PINCE DOUBLE POINTES A COAGULATION
180 MM BAIONNETTE CONNEXION US TYPE
2 FICHES

P123910 BIPOLAR COAGULATION FORCEPS
DOUBLE TIPS 180 MM BAYONET US
CONNECTOR TYPE - 2 PIN



CORDON PR PINCE DOUBLE POINTES A COAGULATION
3 M CONNEXION US TYPE 2 FICHES BIPOLAIRE

P123911 CABLE CONNECTING FOR BIPOLAR COAGULATION
FORCEPS DOUBLE TIPS 3 M US CONNECTION TYPE 2
PLUGS

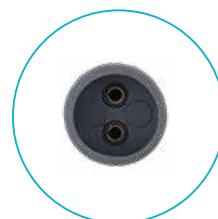

BIPOLAIRE BIPOLAR

PINCE A COAGULATION CLARIS NON-STICK 1 X 200 MM BAIONNETTE MOUSSE

P123914 *NON-STICK COAGULATION FORCEPS 1 X 200 MM BAYONET BLUNT*



CORDON PR PINCE A COAGULATION 3 M FICHE PLATE
PR VALLEYLAB BIPOLAIRE

P123907 *CONNECTING CABLE FOR BIPOLAR COAGULATION
FORCEPS 3 M FLAT PLUG FOR VALLEYLAB*

P123930
CORDON DE 5 M
CONNECTING CABLE 5 M



BIPOLAIRE BIPOLAR

PINCE A COAGULATION 0,3 x 150 MM COUDEE
POINTUE BIPOLAIRE

P123915 *BIPOLAR COAGULATION FORCEPS
0,3 X 150 MM ANGLED SHARP*



PINCE A COAGULATION 1 x 150 MM DROITE
MOUSSE BIPOLAIRE

P123916 *BIPOLAR COAGULATION FORCEPS
1 X 150 MM STRAIGHT BLUNT*



CORDON PR PINCE A COAGULATION 3 M FICHE PLATE
PR VALLEYLAB BIPOLAIRE

P123907 *CONNECTING CABLE FOR BIPOLAR COAGULATION
FORCEPS 3 M FLAT PLUG FOR VALLEYLAB*

P123930
CORDON DE 5 M
CONNECTING CABLE 5 M



BIPOLAIRE
BIPOLAR

PINCE A COAGULATION 2 x 150 MM DROITE
MOUSSE BIPOLAIRE
P123917 BIPOLAR COAGULATION FORCEPS
2 X 150 MM STRAIGHT BLUNT

PINCE A COAGULATION 1 x 180 MM DROITE
MOUSSE BIPOLAIRE
P123919 BIPOLAR COAGULATION FORCEPS
1 X 180 MM STRAIGHT BLUNT

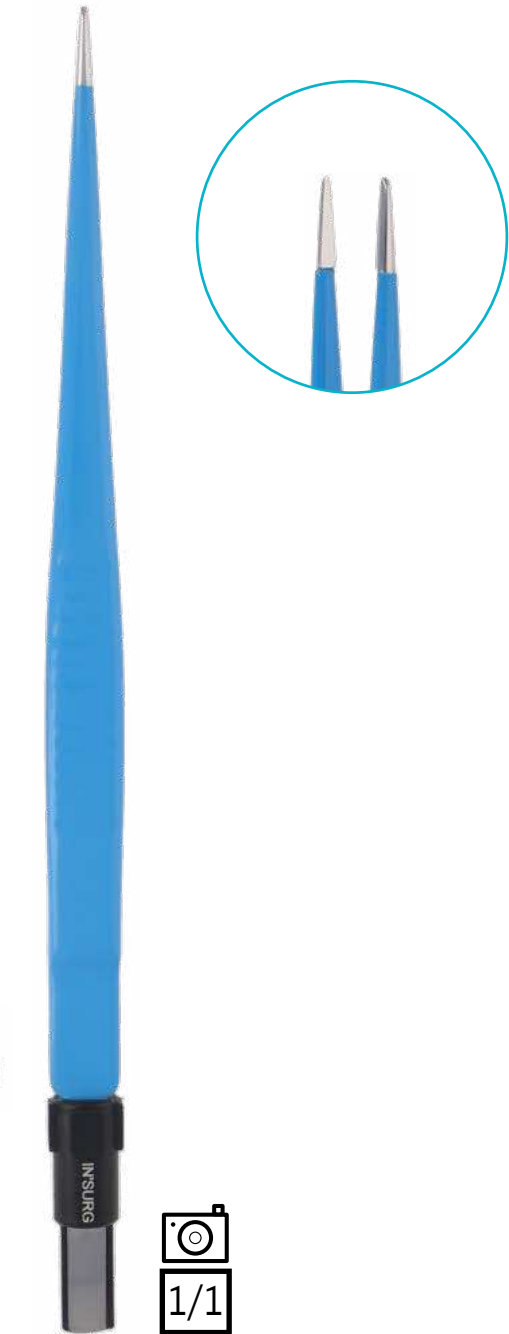

CORDON PR PINCE A COAGULATION 3 M FICHE PLATE
PR VALLEYLAB BIPOLAIRE

P123907 CONNECTING CABLE FOR BIPOLAR COAGULATION
FORCEPS 3 M FLAT PLUG FOR VALLEYLAB

P123930
CORDON DE 5 M
CONNECTING CABLE 5 M



BIPOLAIRE

BIPOLAR

PINCE A COAGULATION 2 x 180 MM
BAIONNETTE MOUSSE BIPOLAIRE

P123918 *BIPOLAR COAGULATION FORCEPS
2 X 180 MM BAYONET BLUNT*

PINCE A COAGULATION 2 x 200 MM BAIONNETTE
MOUSSE BIPOLAIRE

P123920 *BIPOLAR COAGULATION FORCEPS 2 X 200 MM
BAYONET BLUNT*

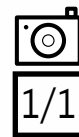

CORDON PR PINCE A COAGULATION 3 M
FICHE PLATE PR VALLEYLAB BIPOLAIRE

P123907 *CONNECTING CABLE FOR BIPOLAR
COAGULATION FORCEPS 3 M FLAT
PLUG FOR VALLEYLAB*

P123930
CORDON DE 5 M
CONNECTING CABLE 5 M



BIPOLAIRE
BIPOLAR

PINCE A COAGULATION 0,3 x 200 MM
BAIONNETTE POINTUE BIPOLAIRE

P123921 BIPOLAR COAGULATION FORCEPS
0,3 X 200 MM BAYONET SHARP



PINCE A COAGULATION 1 x 200 MM COUDEE
MOUSSE BIPOLAIRE

P123922 BIPOLAR COAGULATION FORCEPS
1 X 200 MM ANGLED BLUNT

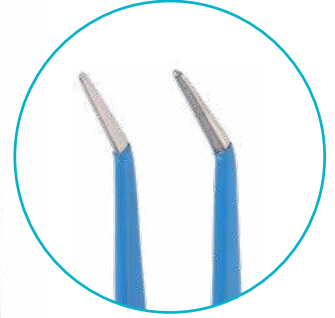

CORDON PR PINCE A COAGULATION 3 M FICHE PLATE
PR VALLEYLAB BIPOLAIRE

P123907 CONNECTING CABLE FOR BIPOLAR COAGULATION
FORCEPS 3 M FLAT PLUG FOR VALLEYLAB

P123930
CORDON DE 5 M
CONNECTING CABLE 5 M

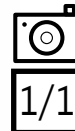
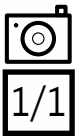

BIPOLAIRE BIPOLAR

PINCE A COAGULATION 1 x 200 MM
DROITE MOUSSE BIPOLAIRE

P123923 *BIPOLAR COAGULATION FORCEPS
1 X 200 MM STRAIGHT BLUNT*

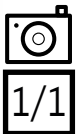

PINCE A COAGULATION 1 x 220 MM
BAIONNETTE MOUSSE BIPOLAIRE

P123924 *BIPOLAR COAGULATION FORCEPS
1 X 220 MM BAYONET BLUNT*

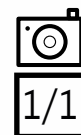

CORDON PR PINCE A COAGULATION 3 M FICHE PLATE
PR VALLEYLAB BIPOLAIRE

P123907 *CONNECTING CABLE FOR BIPOLAR COAGULATION
FORCEPS 3 M FLAT PLUG FOR VALLEYLAB*

P123930
CORDON DE 5 M
CONNECTING CABLE 5 M



BIPOLAIRE
BIPOLAR

PINCE A COAGULATION 0.6 X 180 MM BAIONNETTE MOUSSE CONNEXION US BIPOLAIRE

P123929 *BIPOLAR COAGULATION FORCEPS 0.6 X 180 MM BAYONET BLUNT US TYPE*

PINCE A COAGULATION 1 X 180 MM BAIONNETTE MOUSSE TYPE US

P123928 *BIPOLAR COAGULATION FORCEPS 1 X 180 MM BAYONET BLUNT US TYPE*

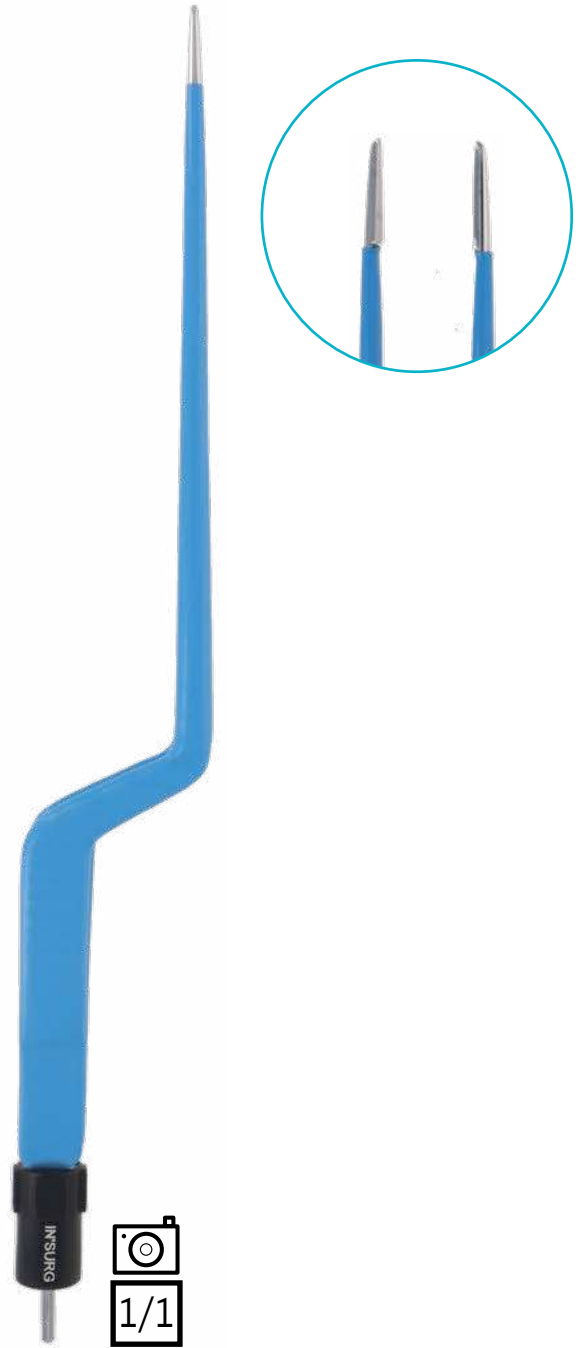
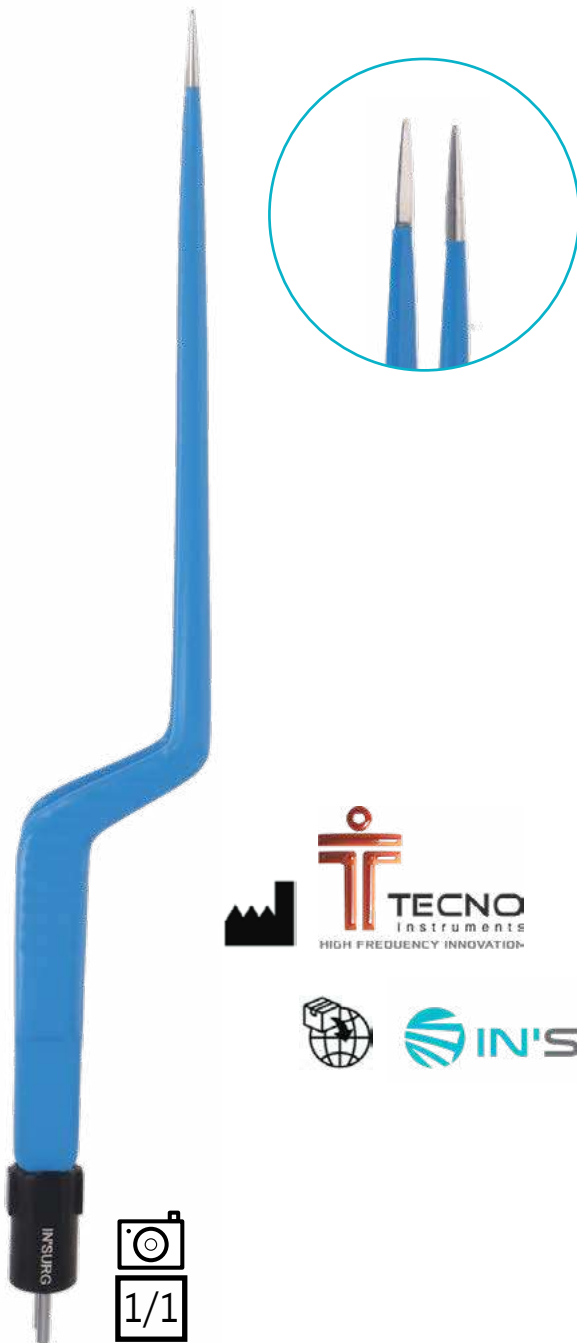

CORDON PR PINCE DOUBLE POINTES A COAGULATION 3 M CONNEXION US TYPE 2 FICHES BIPOLAIRE

P123911 *CABLE CONNECTING FOR BIPOLAR COAGULATION FORCEPS DOUBLE TIPS 3 M US CONNECTION TYPE 2 PLUGS*

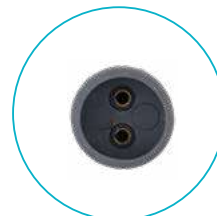

BIPOLAIRE BIPOLAR

PINCE A COAGULATION CLARIS NON-STICK 1 X 240 MM BAIONNETTE MOUSSE
P123927 CLARIS NON-STICK COAGULATION FORCEPS 1 X 240 MM BAYONET BLUNT



PINCE A COAGULATION ADSON
1 X 120 MM DROITE BIPOLAIRE

P123926 ADSON BIPOLAR COAGULATION
FORCEPS 1 X 120 MM STRAIGHT

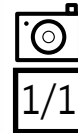

CORDON PR PINCE A COAGULATION 3 M FICHE PLATE
PR VALLEYLAB BIPOLAIRE

P123907 CONNECTING CABLE FOR BIPOLAR COAGULATION
FORCEPS 3 M FLAT PLUG FOR VALLEYLAB

P123930
CORDON DE 5 M
CONNECTING CABLE 5 M



PINCE COUPANTE DOUBLE ARTICULATION

*CUTTING PLIERS
DOUBLE ARTICULATION*

PINCE COUPANTE LISTON
150 MM COUDEE DOUBLE ARTICULATION
P133895 LISTON BONE CUTTING FORCEPS 150 MM
ANGLED DOUBLE ARTICULATION

PINCE COUPANTE LISTON
150 MM DROITE DOUBLE ARTICULATION
P133896 LISTON BONE CUTTING FORCEPS 150 MM
DROITE DOUBLE ARTICULATION



P133898
230 MM

P133900
270 MM



P133899
230 MM

P133901
270 MM



PINCE COUPANTE LISTON RUSKIN 180 MM
COUDEE DOUBLE ARTICULATION

P133903 LISTON RUSKIN BONE CUTTING FORCEPS 180 MM
ANGLED DOUBLE ARTICULATION



PINCE COUPANTE LISTON RUSKIN 180 MM
DROITE DOUBLE ARTICULATION

P133904 LISTON RUSKIN BONE CUTTING
FORCEPS 180 MM STRAIGHT DOUBLE
ARTICULATION



PINCE COUPANTE DOUBLE ARTICULATION

*CUTTING PLIERS
DOUBLE ARTICULATION*

PINCE COUPANTE MAC INDOE 170 MM DOUBLE ARTICULATION

P133905 *MAC INDOE BONE CUTTING FORCEPS 170 MM DOUBLE ARTICULATION*

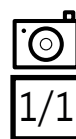

PINCE COUPANTE TUDOR EDWARDS
255 MM DOUBLE ARTICULATION

P133906 *TUDOR EDWARDS BONE CUTTING
FORCEPS 255 MM DOUBLE
ARTICULATION*

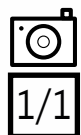

PINCE COUPANTE DOUBLE ARTICULATION

*CUTTING PLIERS
DOUBLE ARTICULATION*

PINCE COUPANTE LISTON KEY HORSLEY
260 MM DOUBLE ARTICULATION
P133902 *LISTON KEY HORSLEY BONE CUTTING
FORCEPS 260 MM DOUBLE ARTICULATION*

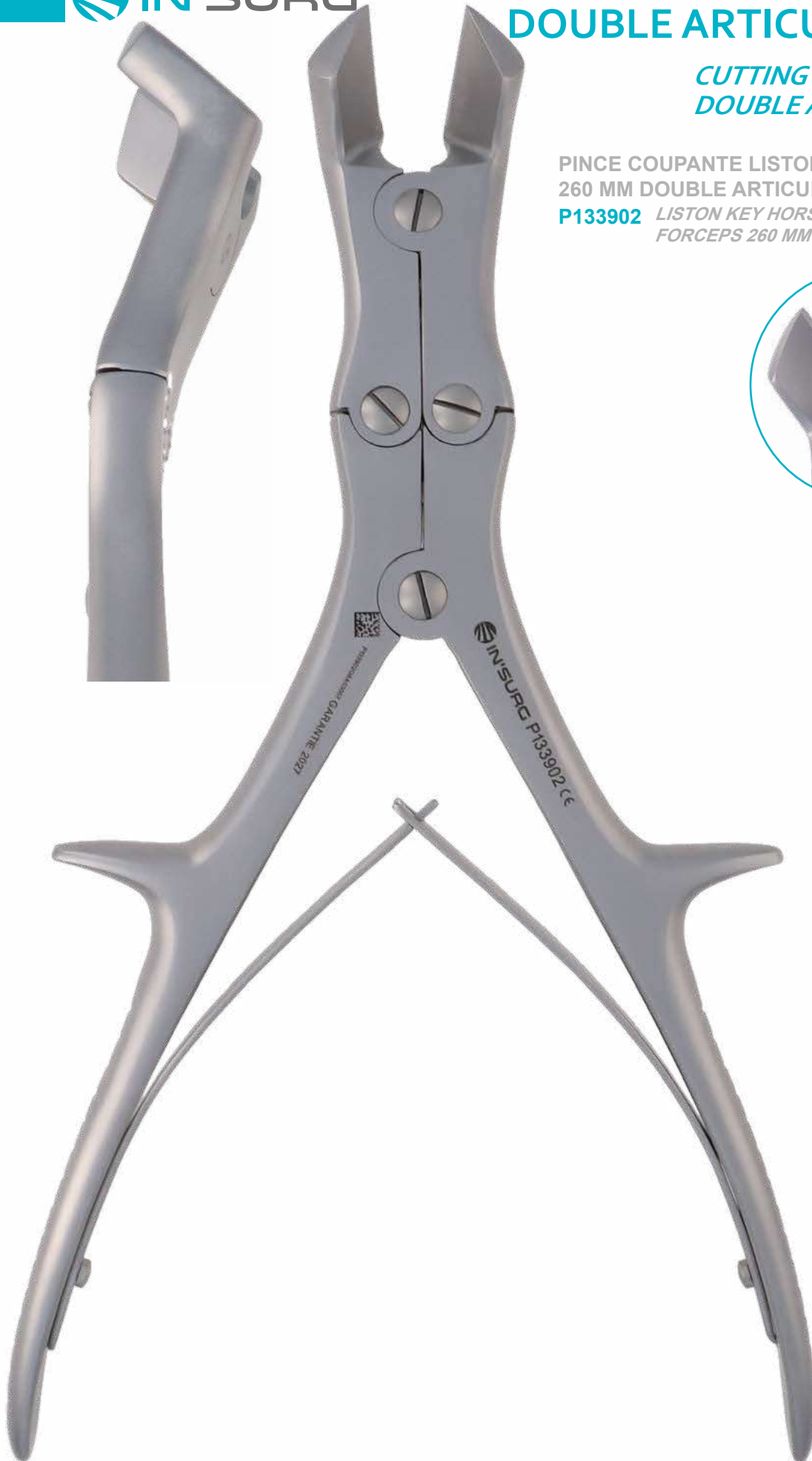

PINCE COUPANTE SIMPLE ARTICULATION

www.in-surg.fr

P

*CUTTING PLIERS SINGLE
ARTICULATION*

PINCE COUPANTE CLEVELAND 170 MM SIMPLE ARTICULATION

P133907 CLEVELAND BONE CUTTING FORCEPS SINGLE ARTICULATION 170 MM



PINCE COUPANTE SIMPLE ARTICULATION

*CUTTING PLIERS SINGLE
ARTICULATION*

PINCE COUPANTE COTTLE KASADJIAN 180 MM SIMPLE ARTICULATION

P133908 *COTTLE KASADJIAN BONE CUTTING FORCEPS SINGLE ARTICULATION 180 MM*

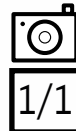

PINCE COUPE BAGUE 170 MM SIMPLE ARTICULATION

P133910 RINGS CUTTING FORCEPS SINGLE ARTICULATION 170 MM



CLE PR PINCE COUPE BAGUE L'UNITE

P133911 KEY FOR RINGS CUTTING FORCEPS UNIT

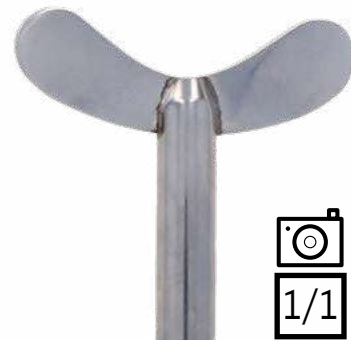

SCIE PR PINCE COUPE BAGUE

P133913 EXTRA SAW BLADE FOR RINGS CUTTING FORCEPS



PINCE COUPANTE SIMPLE ARTICULATION

*CUTTING PLIERS SINGLE
ARTICULATION*

PINCE COUPANTE 140 MM COUPE CLAMP BAR SIMPLE ARTICULATION

P133914 BONE CUTTING FORCEPS 140 MM COUPE CLAMP BAR SINGLE ARTICULATION

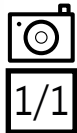

PINCE COUPANTE GARDNER 4 x 180 MM SIMPLE ARTICULATION

P133915 GARDNER BONE CUTTING FORCEPS 4 X 180 MM SINGLE ARTICULATION



P133916
6 X 180 MM

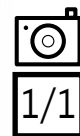

PINCE COUPANTE SIMPLE ARTICULATION

CUTTING PLIERS SINGLE ARTICULATION

PINCE COUPANTE LISTON 150 MM COUDEE
SIMPLE ARTICULATION

P133917 LISTON BONE CUTTING FORCEPS 150 MM
ANGLED SINGLE ARTICULATION



PINCE COUPANTE LISTON LITTAUER
150 MM DROITE SIMPLE ARTICULATION

P133928 LISTON LITTAUER BONE CUTTING
FORCEPS 150 MM STRAIGHT SINGLE
ARTICULATION

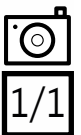

LONGUEUR LENGTH	COUDEE ANGLED	DROITE STRAIGHT
150 MM	P133917	P133918
170 MM	P133919	P133920
190 MM	P133921	P133922
220 MM	P133924	P133925

PINCE COUPANTE VELPEAU 240 MM TRICOISE SIMPLE ARTICULATION

P133929 VELPEAU TRICOISE BONE CUTTING FORCEPS 240 MM SINGLE ARTICULATION

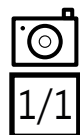

PINCE A DISSEQUER

DISSECTING FORCEPS

PINCE A DISSEQUER ADLERKREUTZ 4,5 x 150 MM LARGE
P143931 ADLERKREUTZ DISSECTING FORCEPS 4,5 X 150 MM WIDE

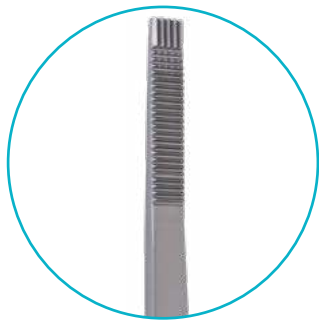

2,5 MM
ETROITE
NARROW

4,5 MM
LARGE
WIDE

LONGUEUR
LENGTH

150 MM

P143930

P143931

200 MM

P143933

P143934

250 MM

P143935

P143936

300 MM

P143937

P143938

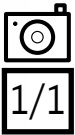

P143932

**PINCE A DISSEQUER
ADELKREUTZ 160 MM ULTRA
LINE**

*ULTRA LINE ADLERKREUTZ
DISSECTING FORCEPS 160 MM*

PINCE A DISSEQUER ADSON MICRO 1 x 120 MM A GRIFFES

P143940 ADSON MICRO DISSECTING FORCEPS 1 X 120 MM WITH TEETH

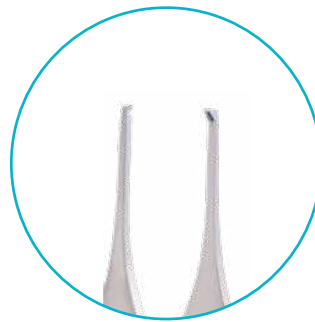
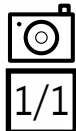

LONGUEUR
LENGTH

120 MM

150 MM

A GRIFFES
WITH TEETH

SANS GRIFFE
WITHOUT TEETH

P143940

P143941

P143953

P143954



P143939

**PINCE A DISSEQUER
ADSON MICRO 120 MM A
GRIFFES ULTRA LINE**

ULTRA LINE ADSON MICRO
DISSECTING FORCEPS
120 MM WITH TEETH

PINCE A DISSEQUER

DISSECTING FORCEPS

PINCE A DISSEQUER ADSON
1,5 x 120 MM A GRIFFE

P143943 ADSON DISSECTING FORCEPS
1,5 X 120 MM WITH TEETH



PINCE A DISSEQUER ADSON
1,5 x 120 MM A GRIFFES STRIEE

P143944 ADSON DISSECTING FORCEPS
1,5 X 120 MM WITH TEETH
STRIATED



SANS GRIFFE
WITHOUT TEETH

P143947

PINCE A DISSEQUER ADSON 125 MM A GRIFFES ULTRA LINE

P143949 ULTRA LINE ADSON DISSECTING FORCEPS 125 MM WITH TEETH



A GRIFFES
WITH TEETH

SANS GRIFFE
WITHOUT TEETH



LONGUEUR

LENGTH

125 MM

P143949

P143950

150 MM

P143951

P143952



PINCE A DISSEQUER ADSON 1,5 x 120 MM A GRIFFES TUNGSTENE
P143945 ADSON DISSECTING FORCEPS 1,5 X 120 MM WITH TEETH TUNGSTEN

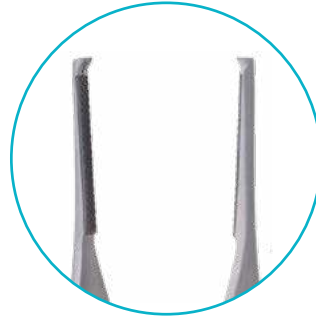
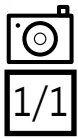

A GRIFFES
WITH TEETH



SANS GRIFFE
WITHOUT TEETH

LONGUEUR
LENGTH

120 MM

150 MM

P143945

P143948

P143955

PINCE A DISSEQUER ADSON 1,5 x 120 MM A GRIFFES ISOLEES
P143942 ADSON DISSECTING FORCEPS 1,5 X 120 MM WITH TEETH INSULATED



A GRIFFES
WITH TEETH



SANS GRIFFE
WITHOUT TEETH

LONGUEUR
LENGTH

120 MM

P143942

P143946

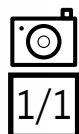

PINCE A DISSEQUER ADSON BROWN 120 MM
P143956 ADSON BROWN DISSECTING FORCEPS 120 MM

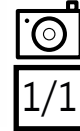
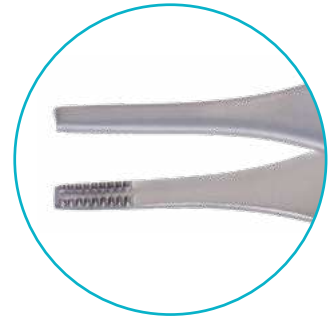

PINCE A DISSEQUER ADSON DEBAKEY 1,5 x 125 MM ATRAUMATIQUE
P143957 ADSON DEBAKEY DISSECTING FORCEPS 1,5 X 125 MM ATRAUMATIC

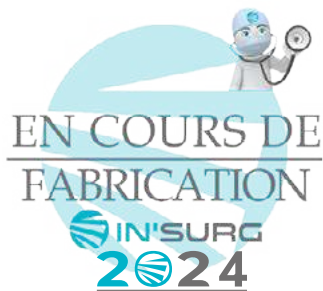

PINCE A DISSEQUER ADSON GRAEFE 120 MM
P143958 ADSON GRAEFE DISSECTING FORCEPS 120 MM

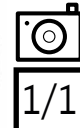
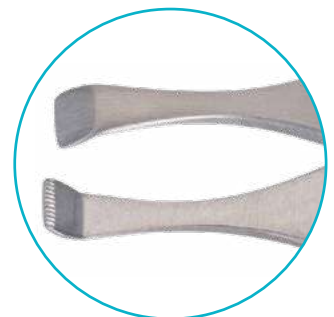

PINCE A DISSEQUER BARRAYA 3 x 200 MM
1 x 2 GRIFFES PARIETALE

P143966 BARRAYA DISSECTING FORCEPS 3 X 200 MM
1 X 2 TEETH PARIETAL

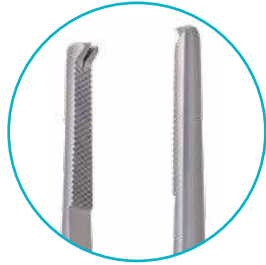

P143967
3 X 250 MM

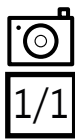

PINCE A DISSEQUER BARRAYA 3,5 x 160 MM
MORS ETROIT POUR VISCERALE

P143959 BARRAYA DISSECTING FORCEPS 3,5 X 160 MM
JAWS NARROW FOR VISCERAL



P143960
3,5 X 180 MM

P143962
3,5 X 200 MM

P143964
3,5 X 250 MM

P143965
3,5 X 300 MM

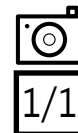

PINCE A DISSEQUER

DISSECTING FORCEPS

PINCE A DISSEQUER BONNEY 180 MM
A GRIFFES

P143968 *BONNEY DISSECTING FORCEPS 180 MM
WITH TEETH*



PINCE A DISSEQUER BARRAYA 3,5 x 180 MM
MORS ETROIT ISOLEE POUR VISCERALE

P143961 *BARRAYA DISSECTING FORCEPS 3,5 X 180 MM
JAWS NARROW FOR VISCERAL
INSULATED*

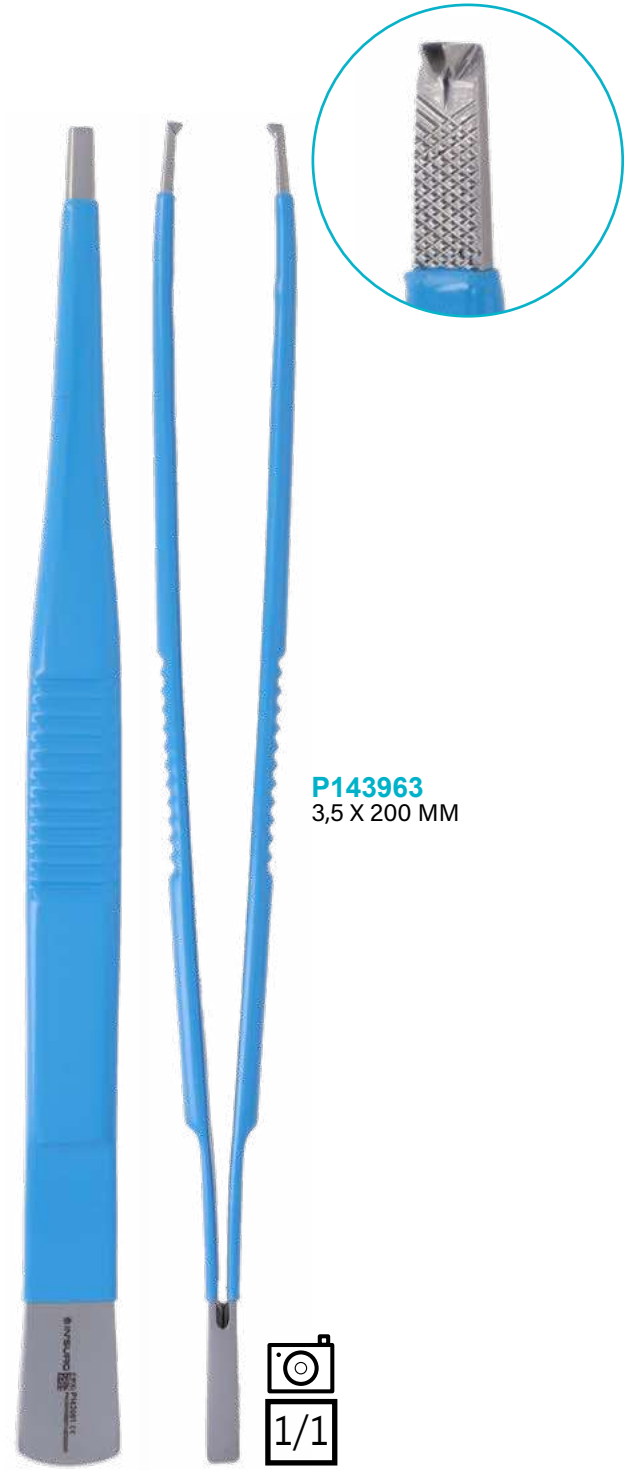

P143963
3,5 X 200 MM

PINCE A DISSEQUER BROPHY 200 MM
SANS GRIFFE

P143970 *BROPHY DISSECTING FORCEPS
200 MM WITHOUT TEETH*

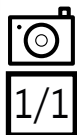

PINCE A DISSEQUER BROPHY 200 MM COURBE
A GRIFFES

P143969 *BROPHY DISSECTING FORCEPS 200 MM
CURVED WITH TEETH*

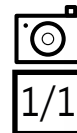

PINCE A DISSEQUER

DISSECTING FORCEPS

PINCE A DISSEQUER BROWN RESANO 160 MM

P143971 *BROWN RESANO DISSECTING FORCEPS 160 MM*

PINCE A DISSEQUER BROWN RESANO 250 MM ISOLEE

P143975 *BROWN RESANO DISSECTING FORCEPS 250 MM INSULATED*



P143972
200 MM

P143973
2 X 200 MM

P143974
250 MM

P143976
2 X 250 MM

P143977
300 MM

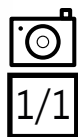

P144252
200 MM



PINCE A DISSEQUER CLOVIS VINCENT 200 MM AVEC GRIFFES

P143980 CLOVIS VINCENT DISSECTING FORCEPS 200 MM WITH TEETH



A GRIFFES
WITH TEETH

SANS GRIFFE
WITHOUT TEETH

LONGUEUR
LENGTH

200 MM
250 MM
300 MM

P143980
P143983
P143987

P143981
P143985
P143988



PINCE ISOLEE A DISSEQUER CLOVIS VINCENT

CLOVIS VINCENT INSULATED DISSECTING FORCEPS

P053726
200 MM A GRIFFES
WITH TEETH

P053727
200 MM SANS GRIFFE
WITHOUT TEETH

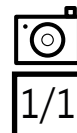
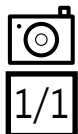

PINCE A DISSEQUER

DISSECTING FORCEPS

PINCE A DISSEQUER CLOVIS VINCENT 200 MM AVEC GRIFFES ULTRA LINE

P143979 ULTRA LINE CLOVIS VINCENT DISSECTING FORCEPS 200 MM WITH TEETH

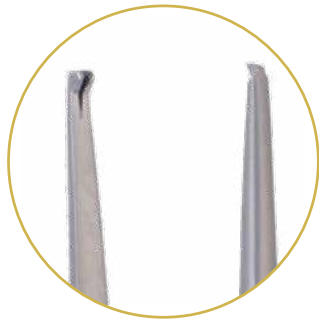

A GRIFFES
WITH TEETH



SANS GRIFFE
WITHOUT TEETH

LONGUEUR
LENGTH

200 MM

P143979

P143982

250 MM

P143984

P143986

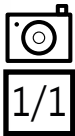

PINCE A DISSEQUER CUSHING
1,8 X 180 MM AVEC GRIFFES

P143990 CUSHING DISSECTING FORCEPS
1,8 X 180 MM WITH TEETH



PINCE A DISSEQUER CUSHING 1,8 X 180 MM
SANS GRIFFE

P143991 CUSHING DISSECTING FORCEPS 1,8 X 180 MM
WITHOUT TEETH



P143992
COURBE SANS GRIFFE
CURVED WITHOUT TEETH

PINCE A DISSEQUER

DISSECTING FORCEPS

PINCE A DISSEQUER CUSHING 1,8 X 180 MM
TUNGSTENE

P143993 CUSHING DISSECTING FORCEPS
1,8 X 180 MM TUNGSTEN



P144199
1 X 180 MM
DROITE
STRAIGHT

P144200
1.8 X 180 MM
COUDEE
ANGLED

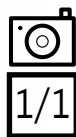

PINCE A DISSEQUER CUSHING 180 MM
SANS GRIFFE ISOLEE

P053729 CUSHING DISSECTING FORCEPS
180 MM WITHOUT TEETH
INSULATED



P053728
180 MM A GRIFFES
WITH TEETH

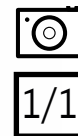

PINCE A DISSEQUER DEBAKEY 1 x 160 MM DROITE ATRAUMATIQUE
P143994 DEBAKEY DISSECTING FORCEPS 1 X 160 MM STRAIGHT ATRAUMATIC

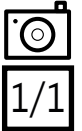
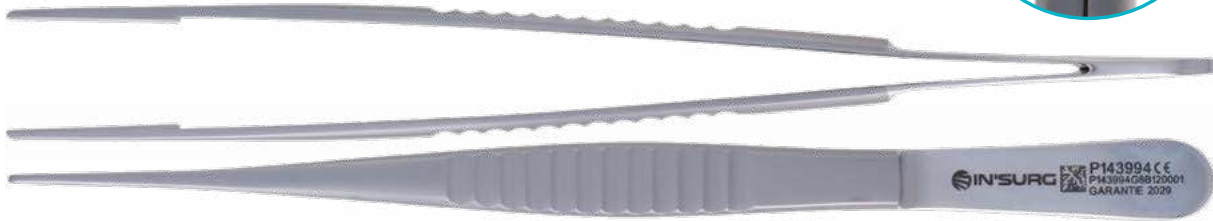

LONGUEUR LENGTH	DIAMETRE DIAMETER				
	1 MM	1.5 MM	2 MM	2,7 MM	3,5 MM
160 MM	P143994	P143997	P144002	P144012	P144019
200 MM	P143995	P143999	P144004	P144013	P144020
240 MM	P143996	P144000	P144007	P144015	P144021
300 MM			P144010	P144017	P144022

PINCE A DISSEQUER DEBAKEY SOUPLE 1,5 x 140 MM DROITE ATRAUMATIQUE

P144025 DEBAKEY DISSECTING FORCEPS SOFT 1,5 X 140 MM STRAIGHT ATRAUMATIC

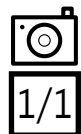

LONGUEUR LENGTH	DIAMETRE DIAMETER			
	1,5 MM	2 MM	2,7 MM	3,5 MM
140 MM	P144025	P144029	P144036	
180 MM	P144026	P144031	P144037	
200 MM		P144032		
220 MM	P144027	P144034	P144038	P144040
240 MM		P144035		

PINCE A DISSEQUER

DISSECTING FORCEPS

PINCE A DISSEQUER DEBAKEY 2 x 160 MM
COUDEE ATRAUMATIQUE

P144001 DEBAKEY DISSECTING FORCEPS
2 X 160 MM ANGLED ATRAUMATIC

PINCE A DISSEQUER DEBAKEY SOUPLE
2 X 220 MM COUDEE ATRAUMATIQUE

P144033 DEBAKEY DISSECTING FORCEPS
SOFT 2 X 220 MM ANGLED
ATRAUMATIC

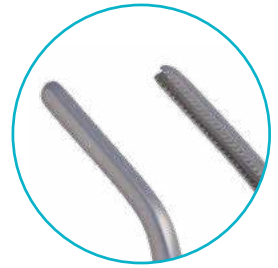

LONGUEUR LENGTH	DIAMETRE DIAMETER
	2 MM
160 MM	P144001
200 MM	P144003
240 MM	P144006
300 MM	P144009



LONGUEUR LENGTH	DIAMETRE DIAMETER
	2 MM
140 MM	P144028
180 MM	P144030
220 MM	P144033



PINCE A DISSEQUER DEBAKEY 1,5 x 160 MM DROITE ATRAUMATIQUE ISOLEE

P143998 DEBAKEY DISSECTING FORCEPS 1,5 X 160 MM STRAIGHT ATRAUMATIC INSULATED

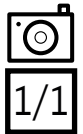
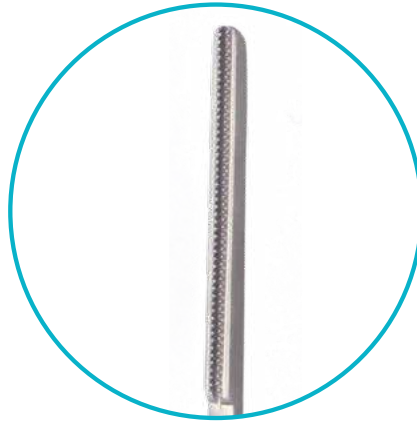

LONGUEUR LENGTH	DIAMETRE DIAMETER			
	1,5 MM	2 MM	2,7 MM	3.5 MM
160 MM	P143998		P144253	
200 MM		P144005	P144014	
240 MM		P144008	P144016	
300 MM		P144011	P144018	P144023

PINCE A DISSEQUER

DISSECTING FORCEPS

PINCE A DISSEQUER DEMARTEL 150 MM AVEC GRIFFES

P144043 DEMARTEL DISSECTING FORCEPS 150 MM WITH TEETH



LONGUEUR
LENGTH

150 MM
200 MM
250 MM
300 MM

A GRIFFES
WITH TEETH

P144043
P144045
P144047
P144049

SANS GRIFFE
WITHOUT TEETH

P144044
P144046
P144048
P144050

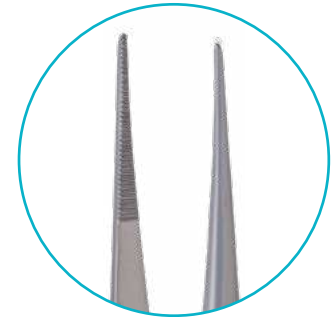

PINCE A DISSEQUER DEMARTEL
250 MM SANS GRIFFE ISOLEE

P053731 DEMARTEL DISSECTING FORCEPS
250 MM WITHOUT TEETH
INSULATED

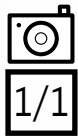

**PINCE A DISSEQUER DEMARTEL
ISOLEE**

DEMARTEL DISSECTING FORCEPS
250 MM INSULATED

P053730
A GRIFFES
WITH TEETH

P053732
SANS GRIFFE
WITHOUT TEETH

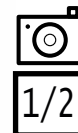
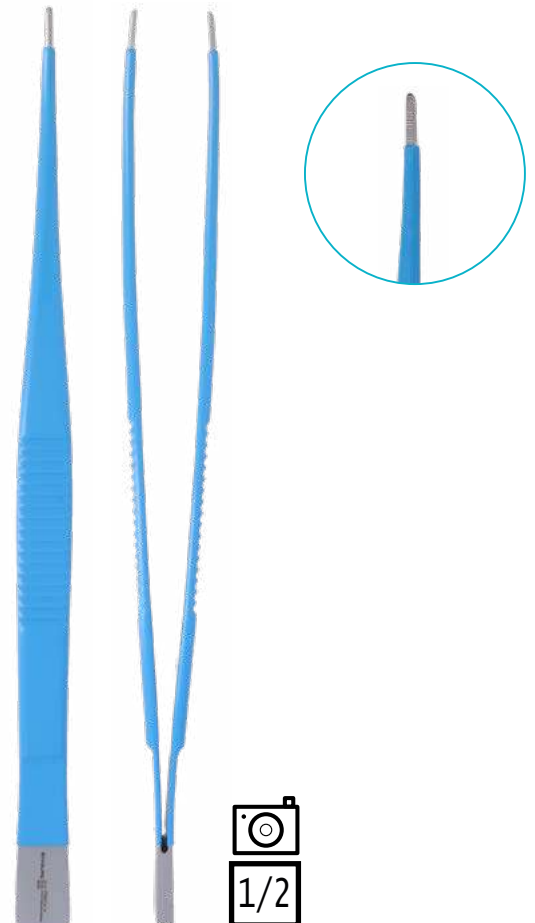

PINCE A DISSEQUER DESGOUTTES
170 MM 9 GRIFFES

P144051 DESGOUTTES DISSECTING
FORCEPS 170 MM 9 TEETH

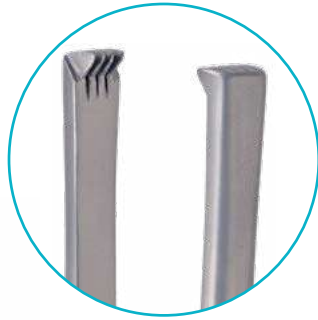

P144052
200 MM

P144053
220 MM

P144054
250 MM

P144055
300 MM

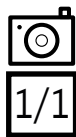

PINCE A DISSEQUER DURAND
PATTE DE VELOURS 7 X 150 MM

P144056 DURAND VELVET PAW DISSECTING
FORCEPS 7 X 150 MM



P144057
7 X 200 MM

P144058
7 X 250 MM

P144059
7 X 300 MM

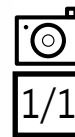

PINCE A DISSEQUER

DISSECTING FORCEPS

PINCE A DISSEQUER DUVAL MORS 10 x 150 MM

P144061 DUVAL DISSECTING FORCEPS JAWS 10 X 150 MM

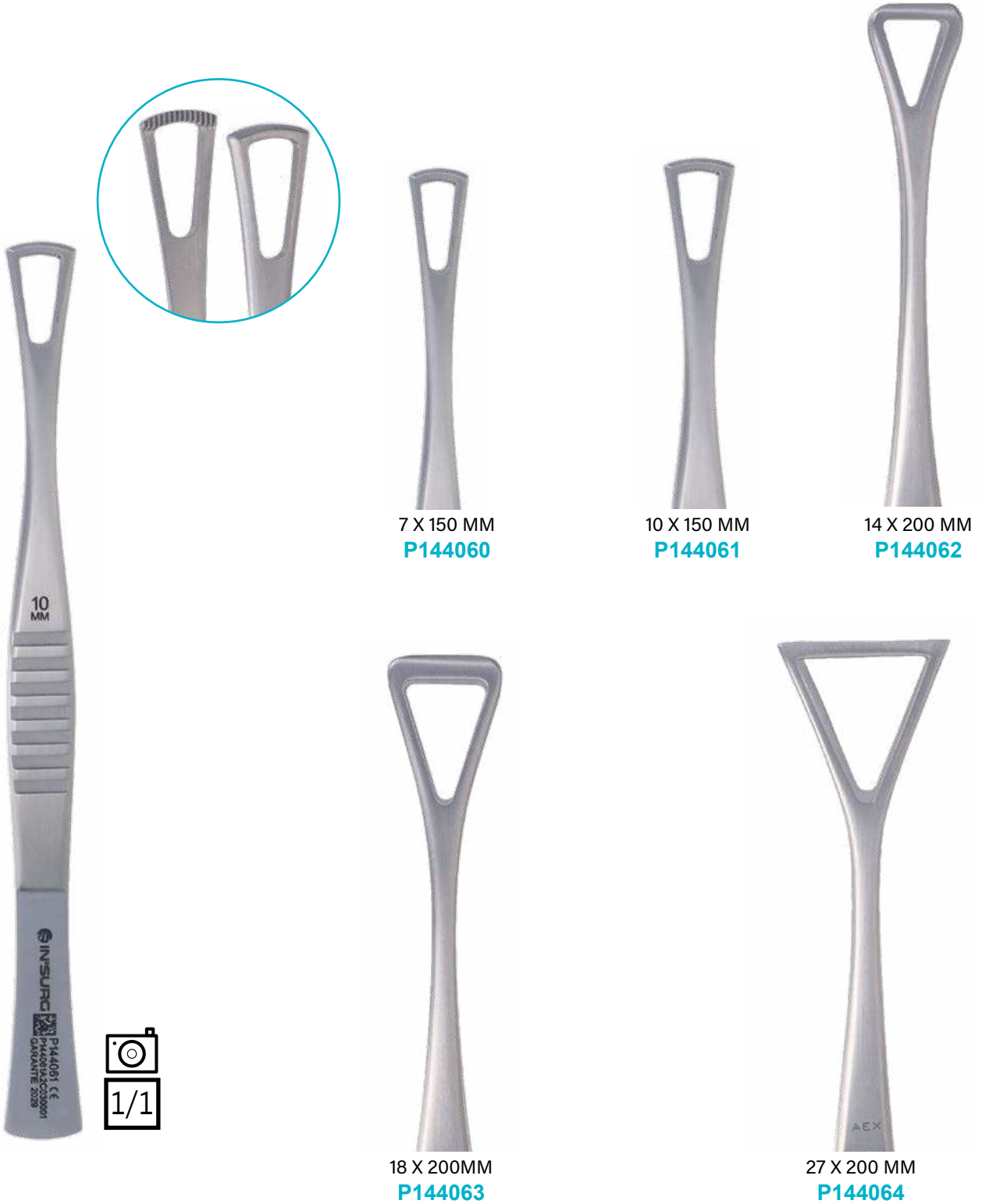

7 X 150 MM
P144060

10 X 150 MM
P144061

14 X 200 MM
P144062

18 X 200MM
P144063

27 X 200 MM
P144064

PINCE A DISSEQUER EVANS
250 MM TUNGSTENE

P144065 *EVANS DISSECTING
FORCEPS
250 MM TUNGSTEN*

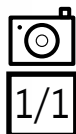

PINCE A DISSEQUER EVANS
250 MM TUNGSTENE ISOLEE

P144066 *EVANS DISSECTING
FORCEPS
250 MM TUNGSTEN
INSULATED*

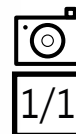

PINCE A DISSEQUER

DISSECTING FORCEPS

PINCE A DISSEQUER GENERAL 3 X 250 MM DROITE MORS
TUNGSTENE

P144071 GENERAL DISSECTING FORCEPS 3 X 250 MM STRAIGHT
TUNGSTEN



P144070
2 X 150 MM



PINCE A DISSEQUER FARKAS 150 MM

P144067 FARKAS DISSECTING FORCEPS 150 MM



P144069
180 MM

PINCE A DISSEQUER FARKAS 150 MM ULTRA LINE

P144068 ULTRA LINE FARKAS DISSECTING FORCEPS 150 MM



PINCE A DISSEQUER GERALD 1,5 X 180 MM SANS GRIFFE

P144077 GERALD DISSECTING FORCEPS 1,5 X 180 MM WITHOUT TEETH

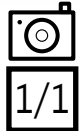

A GRIFFES
WITH TEETH

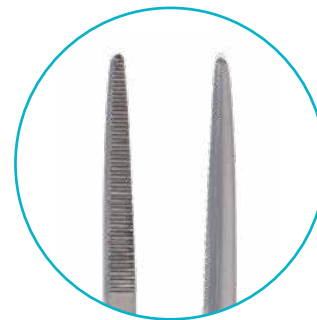

SANS GRIFFE
WITHOUT TEETH

LONGUEUR
LENGTH
180 MM

P144073

P144077

PINCE A DISSEQUER GERALD 1,2 X 180 MM ATRAUMATIQUE

P144072 GERALD DISSECTING FORCEPS 1,2 X 180 MM ATRAUMATIC

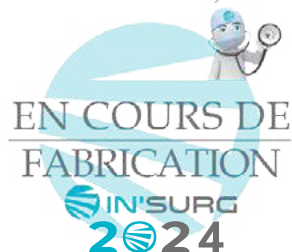

PINCE A DISSEQUER

DISSECTING FORCEPS

PINCE A DISSEQUER GERALD 1,5 X 180 MM SANS GRIFFE MORS TUNGSTENE

P144076 GERALD DISSECTING FORCEPS 1,5 X 180 MM WITHOUT TEETH MORS TUNGSTEN



A GRIFFES
WITH TEETH

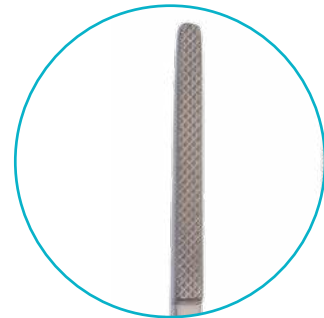

SANS GRIFFE
WITHOUT TEETH

LONGUEUR
LENGTH
180 MM

P144075

P144076

PINCE A DISSEQUER GERALD 1,5 X 180 MM COURBE AVEC GRIFFES

P144074 GERALD DISSECTING FORCEPS 1,5 X 180 MM CURVED WITH TEETH

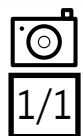

PINCE A DISSEQUER GILLES 150 MM
AVEC GRIFFES

P144079 GILLIES DISSECTING FORCEPS
150 MM WITH TEETH



PINCE A DISSEQUER GILLES 150 MM
AVEC GRIFFES ULTRA LINE

P144080 ULTRA LINE GILLIES DISSECTING
FORCEPS 150 MM WITH TEETH



P144081 SANS GRIFFE
WITHOUT TEETH

PINCE A DISSEQUER GRAEFE 110 MM

P144082 GRAEFE DISSECTING FORCEPS 110 MM

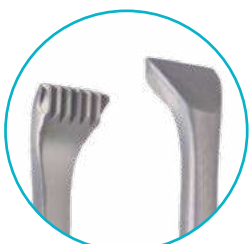

PINCE A DISSEQUER

DISSECTING FORCEPS

PINCE A DISSEQUER GRUENWALD
185 MM EN BAIONNETTE TUNGSTENE

P144086 *GRUENWALD DISSECTING FORCEPS
185 MM BAYONET TUNGSTEN*

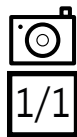

PINCE A DISSEQUER GRUENWALD
200 MM EN BAIONNETTE

P144087 *GRUENWALD DISSECTING FORCEPS
200 MM BAYONET*



PINCE A DISSEQUER J.L. FAURE 200 MM 3 X 4 GRIFFES

P144088 *J.L.FAURE DISSECTING FORCEPS 200 MM 3 X 4 TEETH*

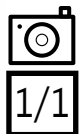

PINCE A DISSEQUER MAC INDOE 1,8 X 150 MM SANS GRIFFE

P144091 *MAC INDOE DISSECTING FORCEPS 1,8 X 150 MM WITHOUT TEETH*

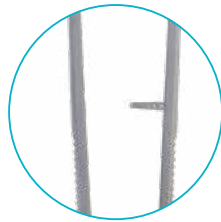

PINCE A DISSEQUER OEHLER 200 MM A GRIFFES TUNGSTENE

P144093 *OEHLER DISSECTING FORCEPS 200 MM WITH TEETH TUNGSTEN*

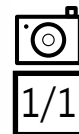

P144089
250 MM
P144090
300 MM

P144204
TUNGSTENE
TUNGSTEN

P144092
145 MM

PINCE A DISSEQUER

DISSECTING FORCEPS

PINCE A DISSEQUER OPHTALMO 100 MM DROITE AVEC GRIFFES

P144094 OPHTALMO DISSECTING FORCEPS 100 MM STRAIGHT WITH TEETH

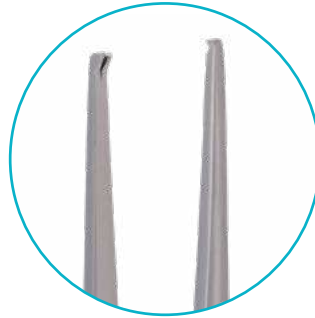
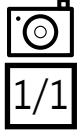

A GRIFFES
WITH TEETH



SANS GRIFFE
WITHOUT TEETH

LONGUEUR
LENGTH
100 MM
110 MM

P144094	P144095
P144102	P144103

PINCE A DISSEQUER OPHTALMO 110 MM COURBE AVEC GRIFFES

P144100 OPHTALMO DISSECTING FORCEPS 110 MM CURVED WITH TEETH



A GRIFFES
WITH TEETH



SANS GRIFFE
WITHOUT TEETH

LONGUEUR
LENGTH
110 MM

P144100	P144101
----------------	----------------

PINCE A DISSEQUER OPHTALMO 100 MM FORTE COURBURE SANS GRIFFE

P144097 OPHTALMO DISSECTING FORCEPS 100 MM BIG CURVATURE WITHOUT TEETH

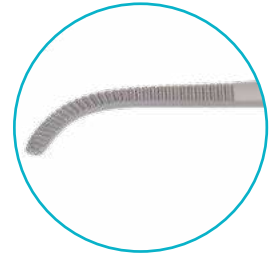

A GRIFFES
WITH TEETH

SANS GRIFFE
WITHOUT TEETH

LONGUEUR LENGTH 100 MM	FORTE COURBURE BIG CURVATURE	PETITE COURBURE SMALL CURVATURE	FORTE COURBURE BIG CURVATURE	PETITE COURBURE SMALL CURVATURE
		P144096	P144098	P144097

PINCE A DISSEQUER PERRY 130 MM COUDEE

P144104 PERRY DISSECTING FORCEPS 130 MM ANGLED

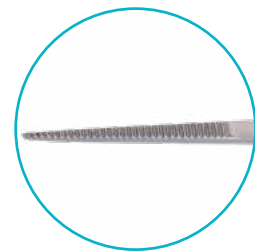

PINCE A DISSEQUER PRECELLE 160 MM DROITE

P144118 PRECELLE DISSECTING FORCEPS 160 MM STRAIGHT



CONTRE COUDEE
COUNTER ANGLED
P144116



COUDEE
ANGLED
P144117

PINCE A DISSEQUER

DISSECTING FORCEPS

PINCE A DISSEQUER POTTS SMITH
180 MM AVEC GRIFFES

P144106 POTTS SMITH DISSECTING FORCEPS
180 MM WITH TEETH

PINCE A DISSEQUER POTTS SMITH 200 MM TUNGSTENE

P144111 POTTS SMITH DISSECTING FORCEPS
200 MM TUNGSTEN

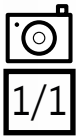

A GRIFFES
WITH TEETH

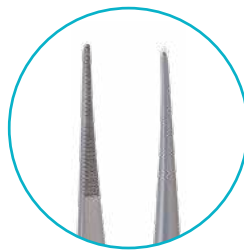

SANS GRIFFE
WITHOUT TEETH



P144105
150 MM

P144108
180 MM

P144112
230 MM

P144115
250 MM

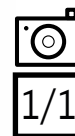

LONGUEUR
LENGTH

180 MM

200 MM

250 MM

P144106

P144109

P144113

P144110

P144114

PINCE A DISSEQUER QUENU NELSON
150 MM

P144119 *QUENU NELSON DISSECTING
FORCEPS 150 MM*



P144121
180 MM

P144122
200 MM

P144124
230 MM

P144125
250 MM

P144127
300 MM

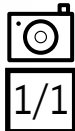

PINCE A DISSEQUER QUENU NELSON 160 MM
ULTRA LINE

P144120 *ULTRA LINE QUENU NELSON
DISSECTING FORCEPS 160 MM*



IN'SURG
ULTRA LINE



P144123
200 MM

P144126
250 MM

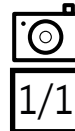

PINCE A DISSEQUER SEMKEN 125 MM 1 X 2 GRIFFES

P144128 SEMKEN NELSON DISSECTING FORCEPS 125 MM 1 X 2 TEETH



1/1



1 X 2 GRIFFES
1 X 2 TEETH

P144128



2 X 3 GRIFFES
2 X 3 TEETH

P144129

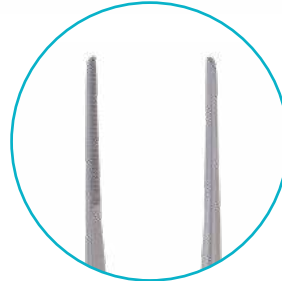

SANS GRIFFE
WITHOUT TEETH

P144131

PINCE A DISSEQUER SEMKEN 125 MM COURBE AVEC GRIFFES

P144130 SEMKEN NELSON DISSECTING FORCEPS 125 MM CURVED WITH TEETH



1/1



A GRIFFES
WITH TEETH
P144130



SANS GRIFFE
WITHOUT TEETH
P144132

PINCE A DISSEQUER SEMKEN 130 MM AVEC GRIFFES ULTRA LINE

P144133 ULTRA LINE SEMKEN DISSECTING FORCEPS 130 MM WITH TEETH



1/1



A GRIFFES
WITH TEETH

P144133



SANS GRIFFE
WITHOUT TEETH

P144134



STANDARD DELICATE
DELICATE STANDARD

PINCE A DISSEQUER STANDARD DELICATE 115 MM AVEC GRIFFES
P144135 *DELICATE STANDARD DISSECTING FORCEPS 115 MM WITH TEETH*

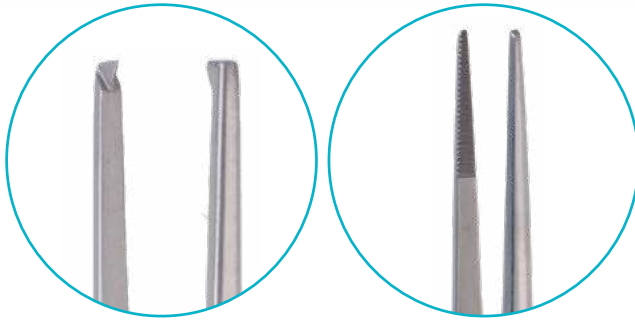
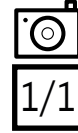

A GRIFFES
WITH TEETH

SANS GRIFFE
WITHOUT TEETH

LONGUEUR
LENGTH

115 MM	P144135	P144136
130 MM	P144137	P144138
145 MM	P144139	P144140
160 MM	P144142	P144143
180 MM	P144144	P144145
200 MM	P144146	P144147
250 MM	P144149	P144150
300 MM	P144151	P144152



P144153

**PINCE A DISSEQUER
STANDARD DELICATE 300 MM
SANS GRIFFE ISOLEE**

*DELICATE STANDARD DISSECTING
FORCEPS 300 MM WITHOUT TEETH
INSULATED*

PINCE A DISSEQUER STANDARD DELICATE 150 MM TUNGSTENE
P144141 *DELICATE STANDARD DISSECTING FORCEPS 150 MM TUNGSTEN*



P144148
200 MM

PINCE A DISSEQUER

DISSECTING FORCEPS

STANDARD STANDARD

PINCE A DISSEQUER STANDARD NORMALE 115 MM 1 X 2 GRIFFES

P144154 NORMAL STANDARD DISSECTING FORCEPS 115 MM 1 X 2 TEETH



SANS GRIFFE
WITHOUT TEETH



1 X 2 GRIFFES
1 X 2 TEETH



2 X 3 GRIFFES
2 X 3 TEETH



COURBE SANS GRIFFE
CURVED WITHOUT TEETH

LONGUEUR
LENGTH

115 MM

P144156

P144154

P144155

130 MM

P144159

P144157

P144158

145 MM

P144162

P144160

P144161

PINCE A DISSEQUER STANDARD NORMAL 200 MM TUNGSTENE

P144171 NORMAL STANDARD DISSECTING FORCEPS 200 MM TUNGSTEN

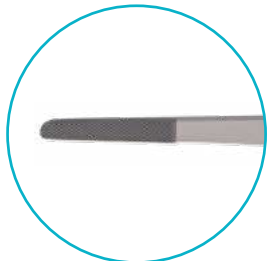

P144163
150 MM

P144171
200 MM

P144175
230 MM

P144180
300 MM

STANDARD
STANDARD

PINCE A DISSEQUER STANDARD 160 MM 1 X 2 GRIFFES

P144164 STANDARD DISSECTING FORCEPS 160 MM 1 X 2 TEETH

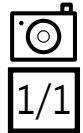

SANS GRIFFE
WITHOUT TEETH



1 X 2 GRIFFES
1 X 2 TEETH



2 X 3 GRIFFES
2 X 3 TEETH



3 X 4 GRIFFES
3 X 4 TEETH

LONGUEUR
LENGTH

LONGUEUR LENGTH	SANS GRIFFE WITHOUT TEETH	1 X 2 GRIFFES 1 X 2 TEETH	2 X 3 GRIFFES 2 X 3 TEETH	3 X 4 GRIFFES 3 X 4 TEETH
160 MM	P144167	P144164	P144165	P144166
180 MM	P144170	P144168	P144169	
200 MM	P144174	P144172	P144173	
250 MM	P144179	P144176	P144178	
300 MM	P144183	P144181	P144182	

PINCE A DISSEQUER STANDARD 250 MM 1 X 2 GRIFFES ISOLEE

P144177 STANDARD DISSECTING FORCEPS 250 MM 1 X 2 TEETH - INSULATED

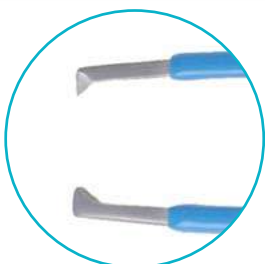

PINCE A DISSEQUER

DISSECTING FORCEPS

PINCE A DISSEQUER STRASBOURG 160 MM

P144185 STRASBOURG DISSECTING
FORCEPS 160 MM

PINCE A DISSEQUER STRASBOURG
200 MM ULTRA LINE

P144189 ULTRA LINE STRASBOURG
DISSECTING FORCEPS 200 MM



P144187
180 MM

P144188
200 MM

P144190
250 MM



IN'SURG
ULTRA LINE



P144186
160 MM

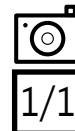
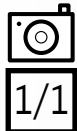

PINCE A DISSEQUER WANGENSTEEN 230 MM

P144196 WANGENSTEEN DISSECTING FORCEPS 230 MM

PINCE A DISSEQUER WANGENSTEEN 150 MM
TUNGSTENE

P144195 WANGENSTEEN DISSECTING FORCEPS
150 MM TUNGSTEN



P144197
230 MM

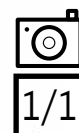

PINCE A DISSEQUER

DISSECTING FORCEPS

PINCE A DISSEQUER WAUGH 200 MM A GRIFFES

P144198 WAUGH DISSECTING FORCEPS 200 MM WITH TEETH

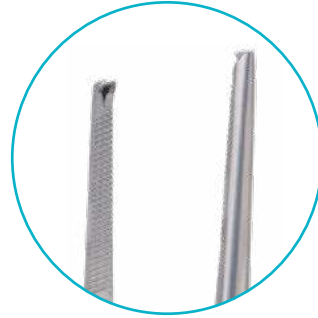

PINCE A DISSEQUER MICRO 150 MM DROITE A GRIFFES CORPS ROND A PLATEAU
P144206 MICRO DISSECTING FORCEPS 150 MM STRAIGHT WITH TEETH ROUND BODY FLAT BED

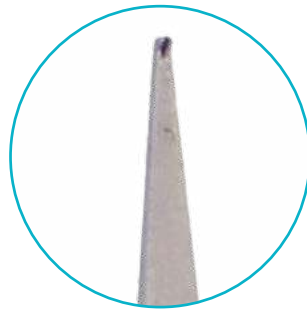
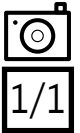

A GRIFFES
WITH TEETH



SANS GRIFFE
WITHOUT TEETH

LONGUEUR
LENGTH

150 MM

P144206

P144207

180 MM

P144209

P144210

PINCE A DISSEQUER MICRO 150 MM COURBE SANS GRIFFE CORPS ROND A PLATEAU
P144205 MICRO DISSECTING FORCEPS 150 MM CURVED WITHOUT TEETH ROUND BODY FLAT BED

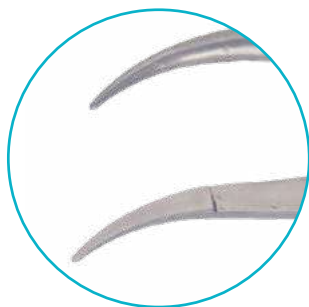

P144208
180 MM

PINCE A DISSEQUER

DISSECTING FORCEPS

PINCE A DISSEQUER MICRO 125 MM SANS GRIFFE CORPS ROND A PLATEAU

P144214 MICRO DISSECTING FORCEPS 125 MM WITHOUT TEETH ROUND BODY FLAT BED

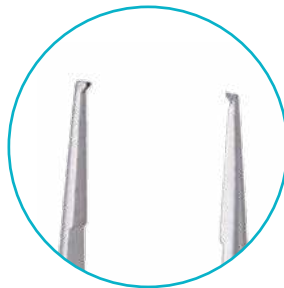
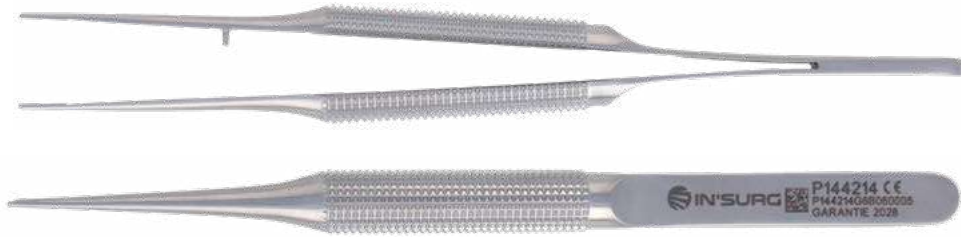

A GRIFFES
WITH TEETH

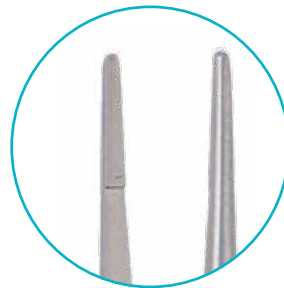

SANS GRIFFE
WITHOUT TEETH

LONGUEUR

LENGTH

- 125 MM
- 150 MM
- 180 MM

P144211

P144214

P144212

P144215

P144213

P144216

PINCE A DISSEQUER MICRO 125 MM COLIBRI CORPS ROND A PLATEAU

P144217 MICRO DISSECTING FORCEPS 125 MM COLIBRI ROUND BODY FLAT BED

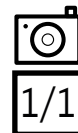

P144218
150 MM

P144219
180 MM

PINCE A DISSEQUER MICRO DUMONT
0,08 x 110 MM FIGURE 3

P144220 DUMONT MICRO DISSECTING FORCEPS
0,08 X 110 MM FIGURE 3



PINCE A DISSEQUER MICRO DUMONT
0,06 x 110 MM FIGURE 4

P144221 DUMONT MICRO DISSECTING FORCEPS
0,06 X 110 MM FIGURE 4



PINCE A DISSEQUER MICRO DUMONT 0,05 x 110 MM FIGURE 5

P144222 DUMONT MICRO DISSECTING FORCEPS 0,05 X 110 MM FIGURE 5



PINCE A DISSEQUER

DISSECTING FORCEPS

PINCE A DISSEQUER MICRO MILLS 1 x 0,5 x 180 MM DROITE CORPS ROND

P144223 MILLS MICRO DISSECTING FORCEPS 1 X 0,5 X 180 MM STRAIGHT ROUND BODY

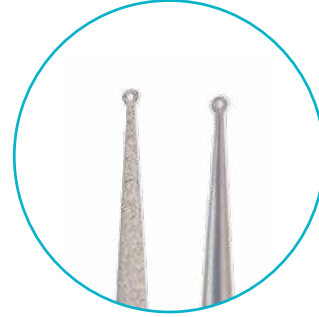

P144224
1 X 1 X 180 MM

P144225
1 X 0,5 X 210 MM

PINCE A DISSEQUER MICRO YASARGIL BAIONNETTE 0,6 x 180 MM MORS DROIT POINTU MANCHE TROUE

P144226 MICRO YASARGIL DISSECTING FORCEPS BAYONET 0,6 X 180 MM STRAIGHT SHARP HOLE HANDLE

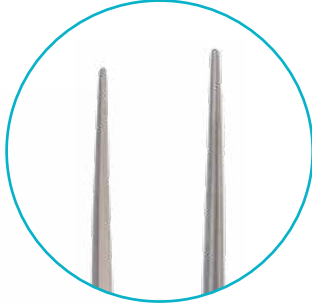

POINTU
SHARP

P144233
0,6 X 240 MM

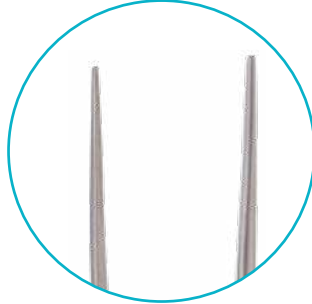

MOUSSE
BLUNT

P144227
0,9 X 180 MM

P144234
0,9 X 240 MM

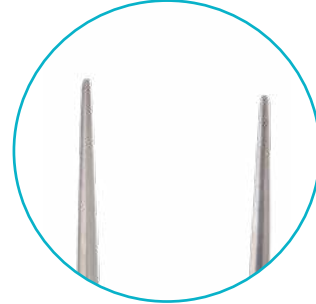

DROIT
STRAIGHT

P144229
0,6 X 200 MM

P144230
0,9 X 200 MM

P144231
0,6 X 220 MM

P144232
0,9 X 220 MM



2 X 2 GRIFFES
2 X 2 TEETH

P144239
3 X 220 MM

P144243
5 X 220 MM



1 X 2 GRIFFES
1 X 2 TEETH

P144228
1,2 X 180 MM

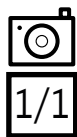

PINCE A DISSEQUER

DISSECTING FORCEPS

PINCE A DISSEQUER TUMEUR YASARGIL BAIONNETTE 3 x 220 MM DENTEE MANCHE TROUE

P144240 YASARGIL DISSECTING FORCEPS BAYONET 3 X 220 MM SERRATED HOLE HANDLE

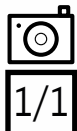

DENTEE
SERRATED

P144235
3 X 160 MM

P144236
5 X 160 MM

P144237
3 X 200 MM

P144238
5 X 200 MM

P144244
5 X 220 MM



LISSE
SMOOTH

P144242
3 X 220 MM

P144245
5 X 220 MM

P144248
3 X 240 MM

P144249
5 X 240 MM



ANGULATION A GAUCHE
LEFT ANGULATED

P144241
3 X 220 MM

P144247
3 X 230 MM



ANGULATION A DROITE
RIGHT ANGULATED

P144246
3 X 230 MM

PINCE A DISSEQUER MICRO 150 MM
SANS GRIFFE CORPS ROND
MORS LISSE

P144250 *MICRO DISSECTING FORCEPS
150 MM WITHOUT TEETH ROUND
BODY JAWS SMOOTH*



PINCE A DISSEQUER GYNECO
HEPP-SCHEIDEL 180 MM MORS ISOLES

P144251 *HEPP-SCHEIDEL DISSECTING
FORCEPS 180 MM JAWS INSULATED*



PINCE DIVERSE (A DRAINS)
VARIOUS FORCEPS (EMPTY THE DRAIN)

PINCE ALU A RESSORT PR
 VIDER LES DRAINS

P154250 *FORCEPS WITH SPRING FOR EMPTY
 THE DRAINS ALU*

PINCE GUNNAR 185 MM PR VIDER LES
 DRAINS DIAM MAX 17 MM

P154254 *FORCEPS FOR EMPTY THE DRAINS
 185 MM DIAM MAX 17 MM*



P154251
**PINCE INOX A RESSORT PR VIDER
 LES DRAINS**
*FORCEPS WITH SPRING FOR EMPTY
 THE DRAINS STAINLESS STEEL*

PINCE DIVERSE (INTUBATION) VARIOUS FORCEPS (INTUBATION)

PINCE MAGILL 250 MM PR INTUBATION ADULTE
P154255 MAGILL INTUBATION FORCEPS 250 MM ADULT



P154258
4.5 X 120 MM
PREMATURE
PREMATURE

P154257
170 MM
NOURISSON
BABY

P154256
200 MM
ENFANT
CHILDREN

P154255
250 MM
ADULTE
ADULT

**PINCE DIVERSE
(PROTEGE CUECUM)**
*VARIOUS FORCEPS
(PROTECT CUECUM)*

PINCE DEMARTEL PROTEGE CUECUM 190 MM
P154259 DEMARTEL FORCEPS PROTECT CUECUM 190 MM



PINCE A ECHARDES

www.in-surg.fr

P

SPLINTER FORCEPS

PINCE A ECHARDES 110 MM DROITE

P154261 *SPLINTER FORCEPS 110 MM STRAIGHT*

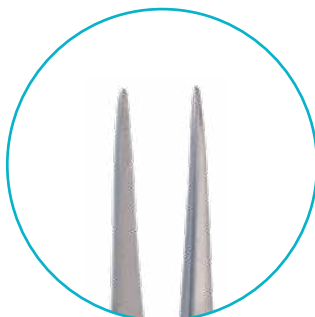

PINCE A ECHARDES FEILCHENFELD 115 MM

P154262 *FEILCHENFELD SPLINTER FORCEPS 115 MM*

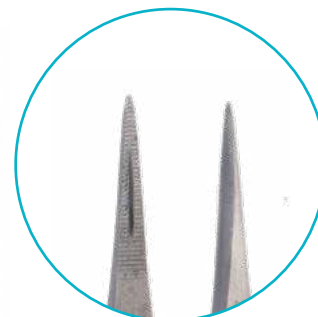

PINCE A ECHARDES PEET 115 MM DOUBLE COURBURE

P154263 *PEET SPLINTER FORCEPS 115 MM DOUBLE CURVATURE*



PINCE A ECHARDES

SPLINTER FORCEPS

PINCE A ECHARDES STIEGLITZ 140 MM COUDEE
P154264 STIEGLITZ SPLINTER FORCEPS 140 MM ANGLED

PINCE A ECHARDES STIEGLITZ 140 MM DROITE
P154265 STIEGLITZ SPLINTER FORCEPS 140 MM STRAIGHT



PINCE A ECHARDES WALTER 110 MM COURBE
P154266 WALTER SPLINTER FORCEPS 110 MM CURVED



PINCE A EPILER

TWEEZER

www.in-surg.fr

P

PINCE A EPILER 80 MM MORS EN BIAIS

P154267 TWEEZERS 80 MM JAWS OBLIQUELY



PINCE A EPILER 80 MM MORS CARRES

P154268 TWEEZERS 80 MM JAWS SQUARES



PINCE A EPILER 80 MM MORS ROUNDS

P154269 TWEEZERS 80 MM JAWS ROUND

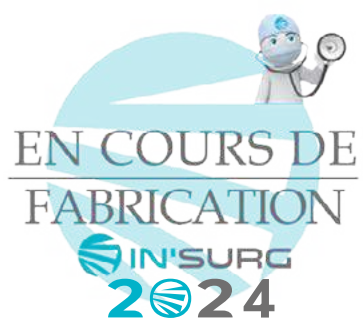

PINCE COUPE FILS

WIRE CUTTING PLIERS

PINCE COUPE FILS 130 MM DIAM MAX 0,7 MM TUNGSTENE

P164270 WIRE CUTTINGS PLIERS FORCEPS 130 MM DIAM MAX 0,7 MM TUNGSTEN

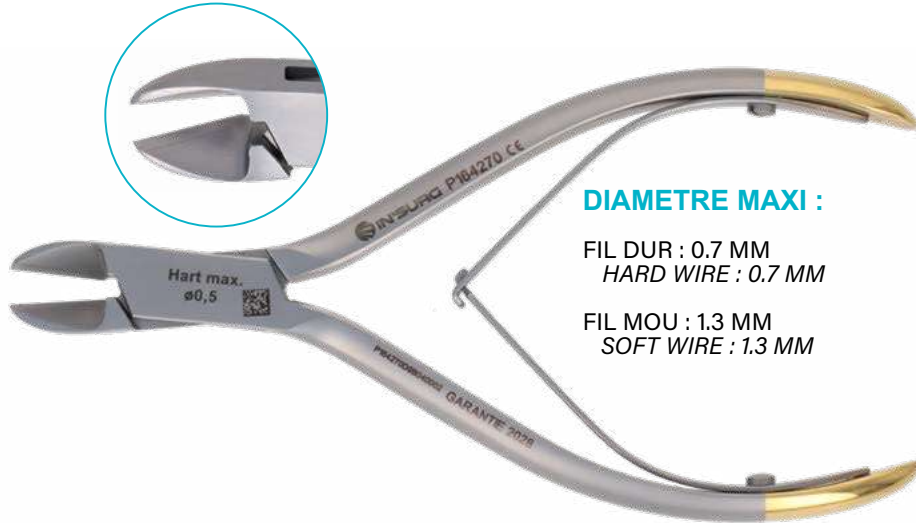

DIAMETRE MAXI :

FIL DUR : 0.7 MM
HARD WIRE : 0.7 MM

FIL MOU : 1.3 MM
SOFT WIRE : 1.3 MM

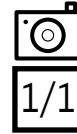

P164271
140 MM 1 MM

DIAMETRE MAXI :

FIL DUR : 1 MM
HARD WIRE : 1 MM

FIL MOU : 1,5 MM
SOFT WIRE : 1.5 MM

PINCE COUPE FILS 150 MM DIAM MAX 1,5 MM DOUBLE ARTICULATION

P164272 WIRE CUTTINGS PLIERS FORCEPS 150 MM DIAM MAX 1,5 MM DOUBLE ARTICULATION



DIAMETRE MAXI :

FIL DUR : 1,5 MM
HARD WIRE : 1.5 MM

FIL MOU : 2 MM
SOFT WIRE : 2 MM



PINCE COUPE FILS 160 MM DIAM MAX 2 MM

P164273 WIRE CUTTINGS PLIERS FORCEPS 160 MM DIAM MAX 2 MM



DIAMETRE MAXI :

FIL DUR : 1,5 MM
HARD WIRE : 1.5 MM

FIL MOU : 2 MM
SOFT WIRE : 2 MM

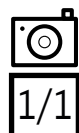

PINCE COUPE FILS 210 MM DIAM MAX 2 MM DOUBLE ARTICULATION TUNGSTENE

P164276 WIRE CUTTINGS PLIERS FORCEPS 210 MM DIAM MAX 2 MM DOUBLE ARTICULATION TUNGSTEN



DIAMETRE MAXI :

FIL DUR : 2 MM
HARD WIRE : 2 MM

FIL MOU : 3.5 MM
SOFT WIRE : 3.5 MM



PINCE COUPE FILS

WIRE CUTTING PLIERS

PINCE COUPE FILS 180 MM DIAM MAX 1,5 MM TUNGSTENE

P164274 WIRE CUTTINGS PLIERS FORCEPS 180 MM DIAM MAX 1,5 MM TUNGSTEN

DIAMETRE MAXI :

FIL DUR : 1,5 MM
HARD WIRE : 1,5 MM

FIL MOU : 2 MM
SOFT WIRE : 2 MM



P164277

220 MM 2 MM

DIAMETRE MAXI :

FIL DUR : 2 MM
HARD WIRE : 2 MM

FIL MOU : 3 MM
SOFT WIRE : 3 MM

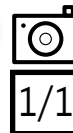

PINCE COUPE FIL 470 MM DIAM MAX 6 MM

P164280 WIRE CUTTINGS PLIERS 470 MM DIAM MAX 6 MM



DIAMETRE MAXI :

FIL DUR : 6 MM
HARD WIRE : 6 MM

MORS POUR PINCE COUPE FILS P164280

P164293 PADS FOR WIRE CUTTINGS PLIERS P164280



VIS ET ECROUS POUR PINCE COUPE FILS
P164280

P164292 SCREW AND NUTS FOR WIRE CUTTINGS
PLIERS P164280

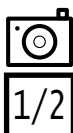

PINCE COUPE FILS

WIRE CUTTING PLIERS

PINCE COUPE FILS 560 MM DIAMETRE MAX 6 MM

P164282 WIRE CUTTINGS PLIERS FORCEPS 560 MM DIAM MAX 6 MM



DIAMETRE MAXI :

FIL DUR : 6 MM
HARD WIRE : 6 MM

MORS POUR PINCE COUPE FILS
P164282

P164283 REPLACEMENT JAWS FOR
WIRE CUTTING PLIERS FORCEPS
P164282



PINCE COUPE FILS 180 MM DIAM MAX 1,5 MM
COUPE LATERALE / TERMINALE

P164290 WIRE CUTTINGS PLIERS FORCEPS 180 MM
DIAM MAX 1,5 MM CUT LATERAL / END

PINCE COUPE FILS REILL 175 MM
DIAM MAX 1,5 MM TUNGSTENE

P164291 REILL WIRE CUTTINGS PLIERS FORCEPS
175 MM DIAM MAX 1,5 MM TUNGSTEN



DIAMETRE MAXI :

FIL DUR : 1.5 MM
HARD WIRE : 1.5 MM

FIL MOU : 2 MM
SOFT WIRE : 2 MM

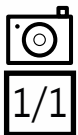

PINCE COUPE FILS

WIRE CUTTING PLIERS

PINCE COUPE FILS HERCULE 230 MM DIAM MAX 3 MM

P164286 HERCULE WIRE CUTTINGS PLIERS FORCEPS 230 MM DIAM MAX 3,0 MM

P164285

180 MM

DIAMETRE MAXI :

FIL DUR : 2.2 MM
HARD WIRE : 2.2 MM

FIL MOU : 2.7 MM
SOFT WIRE : 2.7 MM

P164287

280 MM

DIAMETRE MAXI :

FIL DUR : 3 MM
HARD WIRE : 3 MM

FIL MOU : 3.7 MM
SOFT WIRE : 3.7 MM

PAIRE DE PATINS EN CAOUTCHOUC PR PINCE COUPE FILS HERCULE POUR P164286

P164289 PAIR OF RUBBER PADS CAOUTCHOUC FOR HERCULE WIRE CUTTINGS PLIERS FORCEPS FOR P164286



PAIRE DE PLAQUETTES PR PINCE COUPE FILS HERCULE EN TUNGSTENE POUR P164286

P164288 PAIR OF TUNGSTEN PADS FOR HERCULE WIRE CUTTINGS PLIERS FORCEPS FOR P164286

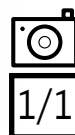
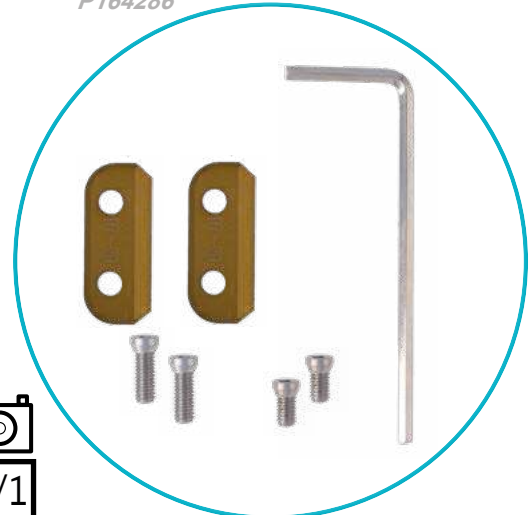

WIRE EXTRACTION PLIERS

PINCE COUPE FILS ACIER
HERCULE 180 MM DIAM MAX 1,6 MM
COUPE FRONTALE / LATERALE MORS
INTERCHANGEABLES TUNGSTENE

P164294 *HERCULE WIRE CUTTINGS PLIERS
FORCEPS 180 MM DIAM MAX 1,6 MM CUT
FRONT / LATERAL INTERCHANGABLE
JAWS TUNGSTEN*

PINCE FILS ACIER HERCULE
3 x 180 MM EXTRACTION
TUNGSTENE

P164296 *HERCULE WIRE CUTTINGS PLIERS
FORCEPS 3 X 180 MM EXTRACTION
TUNGSTEN*

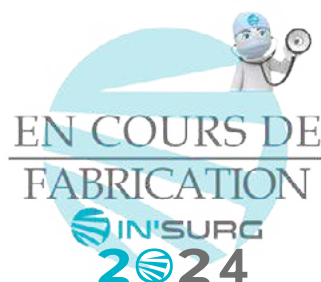

P164297
6 X 180 MM

PAIRE DE PLAQUETTES TUNSTENE ET CLE POUR PINCE COUPE FILS HERCULE POUR P164294

P164295 *PAIR OF TUNGSTEN PADS AND KEY FOR HERCULE WIRE CUTTINGS PLIERS FORCEPS FOR
P164294*

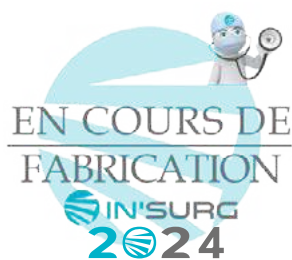

PINCE FILS EXTRACTION 180 MM

P164299 WIRE EXTRACTION PLIERS FORCEPS 180 MM



P164298
130 MM

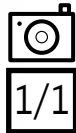

PINCE FILS EXTRACTION 2 x 190 MM PR BROCHE

P164302 WIRE EXTRACTION PLIERS FORCEPS 2 X 190 MM FOR PINS

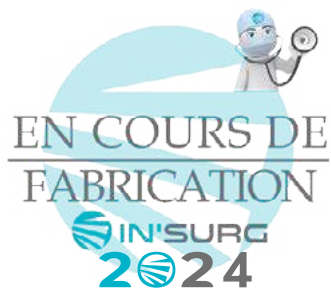

PINCE FILS EXTRACTION 170 MM STRIEE PR BROCHE

P164301 WIRE EXTRACTION PLIERS FORCEPS 170 MM STRIATED FOR PINS

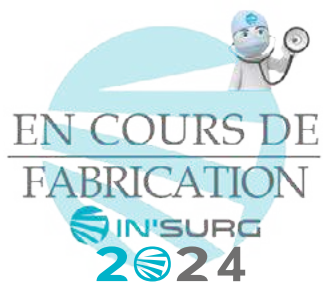

PINCE FILS EXTRACTION 170 MM RAINUREE PR BROCHE

P164300 WIRE EXTRACTION PLIERS FORCEPS 170 MM GROOVED FOR PINS

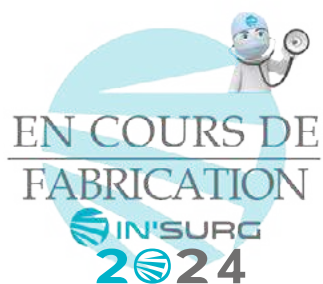

PINCE FILS EXTRACTION

WIRE EXTRACTION PLIERS

PINCE FILS EXTRACTION DEMULTIPLIEE
2,5 x 180 MM TUNGSTENE

P164306 WIRE EXTRACTION PLIERS FORCEPS
STRENGTH MUTILPIED 2,5 X 180 MM
TUNGSTEN

PINCE FILS EXTRACTION DEMULTIPLIEE
3,5 x 180 MM

P164307 WIRE EXTRACTION PLIERS FORCEPS
STRENGTH MUTILPIED 3,5 X 180 MM



P164305
2,5 X 180 MM

P164308
3,5 X 180 MM

PINCE FILS EXTRACTION ET COUPE 150 MM

P164309 WIRE EXTRACTION AND CUTTINGS PLIERS FORCEPS 150 MM



P164310
160 MM

PINCE FILS PREHENSION

WIRE PREHENSION PLIERS

PINCE FILS PREHENSION BERRY
150 MM TUNGSTENE

P164315 BERRY WIRE PREHENSION
PLIERS FORCEPS 150 MM
TUNGSTEN

PORTE AIGUILLE BERRY 190 MM
FILS ACIER ULTRA LINE

P344970 ULTRA LINE BERRY NEEDLE
HOLDER 190 MM STEEL WIRE



P164316
195 MM



IN'SURG
ULTRA LINE

Garantie
totale
10 ANS
sans conditions

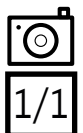

PINCE FILS PREHENSION UNIVERSELLE 180 MM AVEC BLOCAGE INOX

P164320 UNIVERSAL WIRE PREHENSION PLIERS FORCEPS 180 MM WITH BLOCKING STAINLESS STEEL



P164321
200 MM

P164322
240 MM

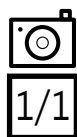

WIRE PREHENSION PLIERS

PINCE FILS PREHENSION UNIVERSELLE
DIAM 1,5 MM x 200 MM INOX

P164317 UNIVERSAL WIRE PREHENSION PLIERS
FORCEPS DIAM 1,5 MM X 200 MM
STAINLESS STEEL

PINCE FILS PREHENSION UNIVERSELLE
140 MM INOX

P164318 UNIVERSAL WIRE PREHENSION
PLIERS FORCEPS 140 MM
STAINLESS STEEL

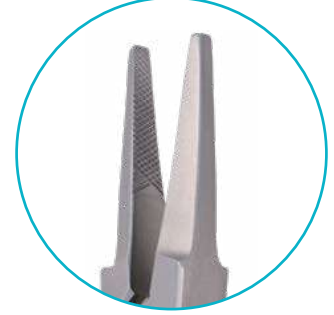

P164319
185 MM
INOX
STAINLESS STEEL



PINCE GOUGE DOUBLE ARTICULATION

www.in-surg.fr

P

BONE RONGEUR DOUBLE ARTICULATION

PINCE GOUGE BEYER 3 x 180 MM
COURBE DOUBLE ARTICULATION

P174325 BEYER BONE RONGEUR 3 X 180 MM
CURVED DOUBLE ARTICULATION

PINCE GOUGE BOHLER 2 x 150 MM
COURBE DOUBLE ARTICULATION

P174326 BOHLER BONE RONGEUR 2 X 150 MM
CURVED DOUBLE ARTICULATION



P174327
3 X 150 MM

P174328
4 X 150 MM

PINCE GOUGE DOUBLE ARTICULATION

BONE RONGEUR DOUBLE ARTICULATION

PINCE GOUGE ECHLIN 4 X 230 MM COUDEE DOUBLE ARTICULATION

P174335 ECHLIN BONE RONGEUR 4 X 230 MM ANGLED DOUBLE ARTICULATION



P174333
2 X 230 MM



P174334
3 X 230 MM

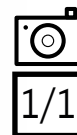

PINCE GOUGE FRYKHOLM 3 x 230 MM DOUBLE ARTICULATION
P174336 FRYKHOLM BONE RONGEUR 3 X 230 MM DOUBLE ARTICULATION



PINCE GOUGE
DOUBLE ARTICULATION*BONE RONGEUR DOUBLE ARTICULATION*

PINCE GOUGE LEKSELL 5 x 230 MM DOUBLE ARTICULATION

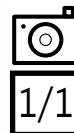
P174337 LEKSELL BONE RONGEUR 5 X 230 MM DOUBLE ARTICULATION**P174339**
8 X 230 MM

PINCE GOUGE LEKSELL 5 x 230 MM COUDEE DOUBLE ARTICULATION BRANCHES TRES COURBES

P174338 LEKSELL BONE RONGEUR 5 X 230 MM ANGLED DOUBLE ARTICULATION VERY CURVED ARMS



P174340
8 X 230 MM

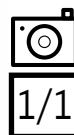

PINCE GOUGE DOUBLE ARTICULATION

BONE RONGEUR DOUBLE ARTICULATION

PINCE GOUGE LUER STILLE 10 x 220 MM COURBE DOUBLE ARTICULATION

P174341 LUER STILLE BONE RONGEUR 10 X 220 MM CURVED DOUBLE ARTICULATION



P174343
17 X 260 MM

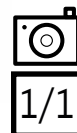

PINCE GOUGE LUER STILLE 10 x 220 MM DROITE DOUBLE ARTICULATION

P174342 LUER STILLE BONE RONGEUR 10 X 220 MM STRAIGHT DOUBLE ARTICULATION



P174344
17 X 260 MM



PINCE GOUGE DOUBLE ARTICULATION

BONE RONGEUR DOUBLE ARTICULATION

PINCE GOUGE MARQUARDT 3 x 200 MM
COURBE DOUBLE ARTICULATION

P174345 MARQUARDT BONE RONGEUR 3 X 200 MM
CURVED DOUBLE ARTICULATION

PINCE GOUGE MAYFIELD 3 x 180 MM
COURBE DOUBLE ARTICULATION

P174346 MAYFIELD BONE RONGEUR 3 X 180 MM
CURVED DOUBLE ARTICULATION

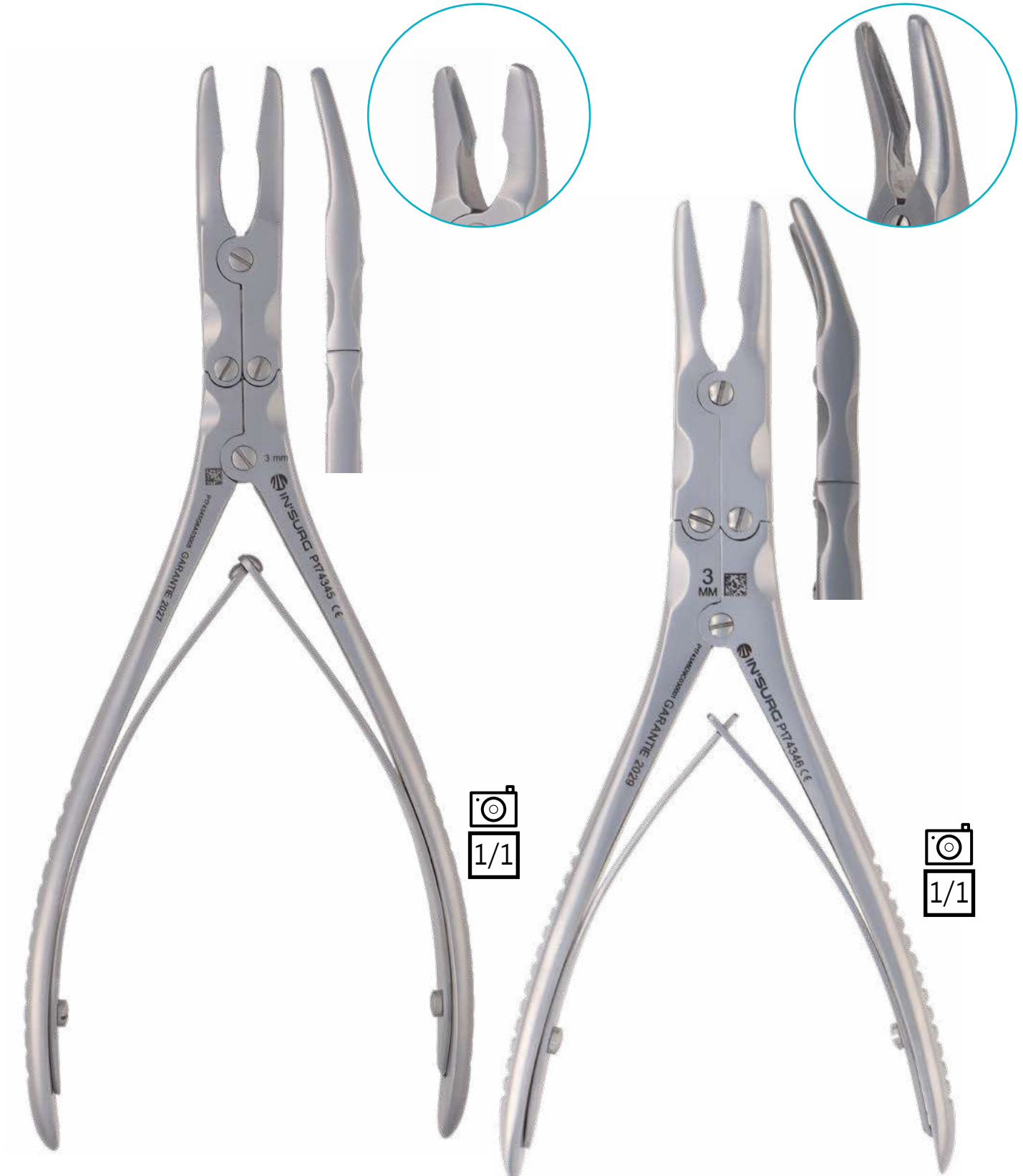

**PINCE GOUGE RUSKIN 5 x 190 MM COURBE
DOUBLE ARTICULATION**

P174347 *RUSKIN BONE RONGEUR 5 X 190 MM
CURVED DOUBLE ARTICULATION*

**PINCE GOUGE RUSKIN 5 x 190 MM DROITE
DOUBLE ARTICULATION**

P174348 *RUSKIN BONE RONGEUR 5 X 190 MM
STRAIGHT DOUBLE ARTICULATION*



PINCE GOUGE DOUBLE ARTICULATION

BONE RONGEUR DOUBLE ARTICULATION

PINCE GOUGE RUSKIN 5 x 240 MM COURBE DOUBLE ARTICULATION

P174350 *RUSKIN BONE RONGEUR 5 X 240 MM CURVED DOUBLE ARTICULATION*



PINCE GOUGE SAUERBRUCH 300 MM DROITE MORS ROUNDS DOUBLE ARTICULATION

P174352 SAUERBRUCH BONE RONGEUR 300 MM STRAIGHT ROUND JAWS DOUBLE ARTICULATION

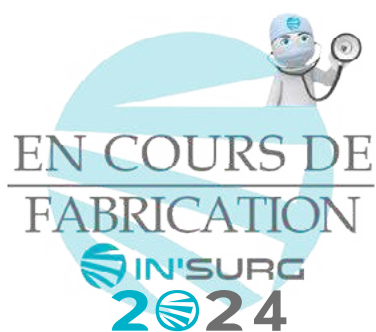

PINCE GOUGE SAUERBRUCH 300 MM DROITE MORS CARRES DOUBLE ARTICULATION

P174351 SAUERBRUCH BONE RONGEUR 300 MM STRAIGHT SQUARE JAWS DOUBLE ARTICULATION

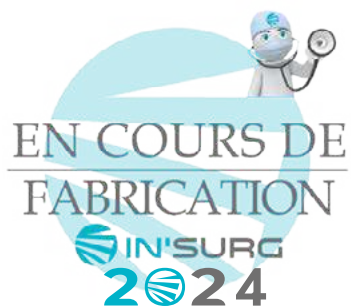

PINCE GOUGE DOUBLE ARTICULATION

BONE RONGEUR DOUBLE ARTICULATION

PINCE GOUGE SEMB 15 x 230 MM COURBE DOUBLE ARTICULATION

P174353 SEMB BONE RONGEUR 15 X 230 MM CURVED DOUBLE ARTICULATION

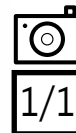

PINCE GOUGE SMITH PETERSEN 230 MM COURBE DOUBLE ARTICULATION

P174355 SMITH PETERSEN BONE RONGEUR 230 MM CURVED DOUBLE ARTICULATION

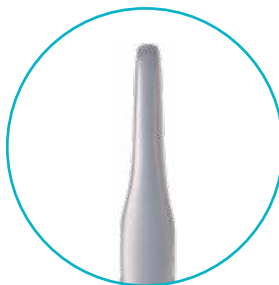
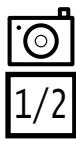
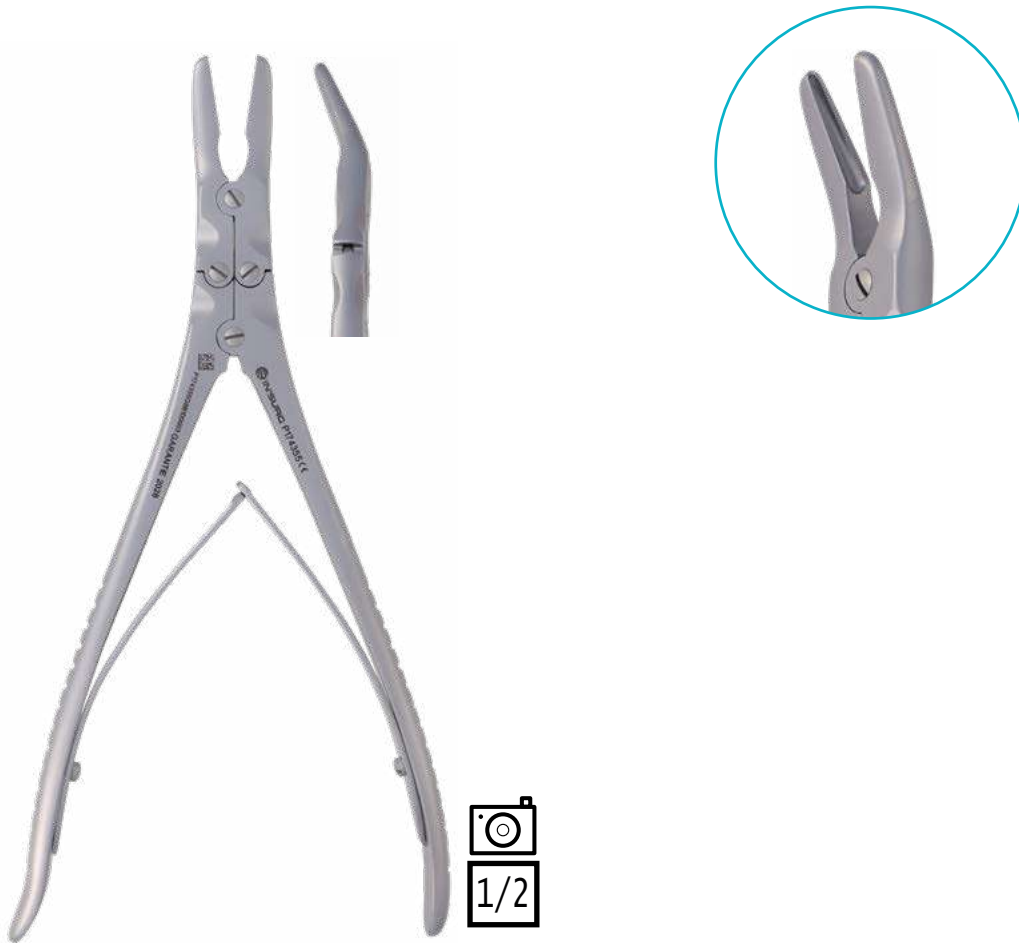

COURBE
CURVED

DROITE
STRAIGHT

ANGULE
ANGLED

LONGUEUR
LENGTH

230 MM

P174355

P174356

P174354

PINCE GOUGE DOUBLE ARTICULATION

BONE RONGEUR DOUBLE ARTICULATION

PINCE GOUGE STILLE 8 x 230 MM ANGULEE DOUBLE ARTICULATION

P174358 STILLE BONE RONGEUR 8 X 230 MM ANGLED DOUBLE ARTICULATION



LONGUEUR LENGTH	COURBE CURVED	DROITE STRAIGHT	ANGULE ANGLED
230 MM	P174359	P174360	P174358

PINCE GOUGE ZAUFAL JANSEN 4 x 180 MM COURBE DOUBLE ARTICULATION

P174361 ZAUFAL JANSEN BONE RONGEUR 4 X 180 MM CURVED DOUBLE ARTICULATION



PINCE GOUGE SIMPLE ARTICULATION

BONE RONGEUR SINGLE ARTICULATION

PINCE GOUGE ADSON 8 x 200 MM DROITE SIMPLE ARTICULATION

P174363 ADSON BONE RONGEUR 8 X 200 MM STRAIGHT SINGLE ARTICULATION



P174364
10 X 240 MM

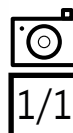

PINCE GOUGE BACON 6 x 200 MM COUDEE SIMPLE ARTICULATION

P174365 BACON BONE RONGEUR 6 X 200 MM ANGLED SINGLE ARTICULATION



PINCE GOUGE SIMPLE ARTICULATION

BONE RONGEUR SINGLE ARTICULATION

PINCE GOUGE BEYER 3 x 170 MM COURBE SIMPLE ARTICULATION

P174366 BEYER BONE RONGEUR 3 X 170 MM CURVED SINGLE ARTICULATION

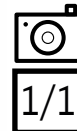

PINCE GOUGE BLUMENTHAL 3 x 160 MM COUDEE A 30° SIMPLE ARTICULATION

P174367 *BLUMENTHAL BONE RONGEUR 3 X 160 MM ANGLED 30° SINGLE ARTICULATION*



P174368
3 X 160 MM
COUDEE A 45°
ANGLED AT 45°

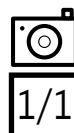

PINCE GOUGE SIMPLE ARTICULATION

BONE RONGEUR SINGLE ARTICULATION

PINCE GOUGE CLEVELAND 3,5 x 170 MM COURBE SIMPLE ARTICULATION

P174370 CLEVELAND BONE RONGEUR 3,5 X 170 MM CURVED SINGLE ARTICULATION



P174369
140 MM

PINCE GOUGE CLOVIS VINCENT 3 x 210 MM SIMPLE ARTICULATION

P174371 CLOVIS VINCENT BONE RONGEUR 3 X 210 MM SINGLE ARTICULATION



P174372
3 X 260 MM

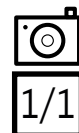

PINCE GOUGE SIMPLE ARTICULATION

BONE RONGEUR SINGLE ARTICULATION

PINCE GOUGE HAKANSON 170 MM COURBE SIMPLE ARTICULATION

P174375 HAKANSON BONE RONGEUR 170 MM CURVED SINGLE ARTICULATION

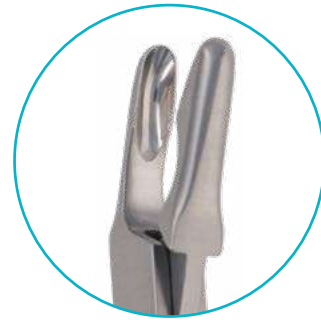

PINCE GOUGE JANSEN 4 x 170 MM COURBE SIMPLE ARTICULATION

P174376 JANSEN BONE RONGEUR 4 X 170 MM CURVED SINGLE ARTICULATION



P174378
4 X 170 MM
DROITE
STRAIGHT

PINCE GOUGE SIMPLE ARTICULATION

BONE RONGEUR SINGLE ARTICULATION

PINCE GOUGE JANSEN 4 X 190 MM DOUBLE COURBURE SIMPLE ARTICULATION

P174377 *JANSEN BONE RONGEUR 4 X 190 MM DOUBLE CURVATURE SINGLE ARTICULATION*

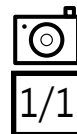

PINCE GOUGE MEAD 170 MM COURBE SIMPLE ARTICULATION

P174387 MEAD BONE RONGEUR 170 MM CURVED SINGLE ARTICULATION

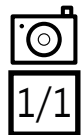

PINCE GOUGE SIMPLE ARTICULATION

BONE RONGEUR SINGLE ARTICULATION

PINCE GOUGE OLIVECRONA 4 X 200 MM TRES COURBE SIMPLE ARTICULATION

P174388 *OLIVECRONA BONE RONGEUR 4 X 200 MM VERY CURVED SINGLE ARTICULATION*

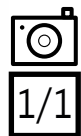

PINCE GOUGE LEMPERS 2 x 190 MM COURBE SIMPLE ARTICULATION

P174380 LEMPERS BONE RONGEUR 2 X 190 MM CURVED SINGLE ARTICULATION



PINCE GOUGE SIMPLE ARTICULATION

BONE RONGEUR SINGLE ARTICULATION

PINCE GOUGE LEMPert 2 x 190 MM DROITE SIMPLE ARTICULATION

P174381 LEMPert BONE RONGEUR 2 X 190 MM STRAIGHT SINGLE ARTICULATION

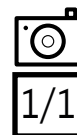

PINCE GOUGE LUER 8 x 170 MM
COURBE SIMPLE ARTICULATION

P174384 LUER BONE RONGEUR 8 x 170 MM
CURVED SINGLE ARTICULATION



PINCE GOUGE LUER FRIEDMANN 2 x 140 MM
COURBE SIMPLE ARTICULATION

P174386 LUER FRIEDMANN BONE
RONGEUR 2 X 140 MM CURVED SINGLE
ARTICULATION



P174383
5 X 145 MM

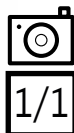

PINCE GOUGE SIMPLE ARTICULATION

BONE RONGEUR SINGLE ARTICULATION

PINCE GOUGE LUER 8 x 170 MM DROITE SIMPLE ARTICULATION

P174385 LUER BONE RONGEUR 8 X 170 MM STRAIGHT SINGLE ARTICULATION



PINCE GOUGE STELLBRINK 2 x 170 MM
COURBE SIMPLE ARTICULATION

P174390 STELLBRINK BONE RONGEUR
2 X 170 MM CURVED SINGLE
ARTICULATION

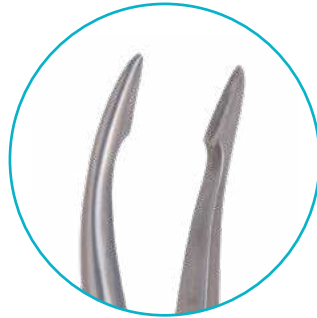

PINCE GOUGE STELLBRINK 2 x 170 MM
TRES COURBE SIMPLE ARTICULATION

P174391 STELLBRINK BONE RONGEUR
2 X 170 MM VERY CURVED
SINGLE ARTICULATION

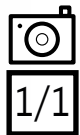

PINCE GOUGE SIMPLE ARTICULATION

BONE RONGEUR SINGLE ARTICULATION

PINCE GOUGE SICARD 230 MM DROITE SIMPLE ARTICULATION

P174389 SICARD BONE RONGEUR 230 MM STRAIGHT SINGLE ARTICULATION



PINCE GOUGE TRILLAT 6 x 250 MM A VIS SIMPLE ARTICULATION

P174394 TRILLAT BONE RONGEUR 6 X 250 MM WITH SCREW SINGLE ARTICULATION



PINCE GYNECO

GYNECO FORCEPS

PINCE GYNECO ARMYTAGE 210 MM
P184395 ARMYTAGE GYNECO FORCEPS 210 MM

PINCE GYNECO BEACHAM 260 MM
 PERCE MEMBRANE
P184396 BEACHAM GYNECO FORCEPS 260 MM
 AMNIOTOME

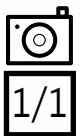
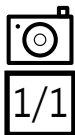

PINCE GYNECO CIRCERON 210 MM PR PREHENSION STERILET

P184397 CIRCERON GYNECO FORCEPS 210 MM PREHENSION OF THE COIL



1/1

PINCE GYNECO

GYNECO FORCEPS

PINCE GYNECO COLLIN 250 MM MORS MOBILES HYSTEROLABE

P184398 COLLIN GYNECO FORCEPS 250 MM MOVING JAWS HYSTEROLABE

1/1

PINCE GYNECO COTT 6 x 210 MM A LAMBEAUX

P184399 COTT GYNECO FORCEPS 6 X 210 MM FOR FRAGMENTS



PINCE GYNECO

GYNECO FORCEPS

PINCE GYNECO DARTIGUES
270 MM HYSTEROLABE

P184401 DARTIGUES GYNECO
FORCEPS 270 MM
HYSTEROLABE

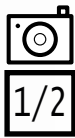

PINCE GYNECO DOYEN 200 MM POLYPES

P184402 DOYEN GYNECO FORCEPS 200 MM POLYPES



PINCE GYNECO DUPLAY 280 MM
P184403 *DUPLAY GYNECO FORCEPS 280 MM*



PINCE GYNECO BONNAIRE
320 MM FAUX GERMES
P184404 *BONNAIRE GYNECO FORCEPS
320 MM OVUM*



PINCE GYNECO

GYNECO FORCEPS

PINCE GYNECO COLLIN MORS MOBILES HYSTEROLABE COUDEE
P184407 COLLIN GYNECO FORCEPS MOVING JAWS HYSTEROLABE ANGLED

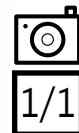

PINCE GYNECO JACOBS 215 MM COURBE
2 x 2 GRIFFES

P184408 JACOBS GYNECO FORCEPS
215 MM CURVED 2 X 2 TEETH

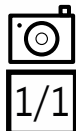

PINCE GYNECO JACOBS 215 MM DROITE
2 x 2 GRIFFES

P184409 JACOBS GYNECO FORCEPS
215 MM STRAIGHT 2 X 2 TEETH

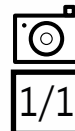

PINCE GYNECO

GYNECO FORCEPS

PINCE GYNECO JEAN LOUIS FAURE 200 MM FINE PR ARTERE UTERINE

P184411 JEAN LOUIS FAURE GYNECO FORCEPS 200 MM SLIM FOR UTERINE ARTERY



PINCE GYNECO JEAN LOUIS FAURE 200 MM FORTE PR ARTERE UTERINE

P184412 JEAN LOUIS FAURE GYNECO FORCEPS 200 MM STRONG FOR UTERINE ARTERY

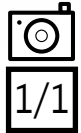

PINCE GYNECO JEAN LOUIS FAURE 200 MM FINE SANS GRIFFE

P184413 JEAN LOUIS FAURE GYNECO FORCEPS 200 MM SLIM WITHOUT TEETH



PINCE GYNECO JEAN LOUIS FAURE 200 MM COURBE SANS GRIFFE

P184414 JEAN LOUIS FAURE GYNECO FORCEPS 200 MM CURVED WITHOUT TEETH



PINCE GYNECO JEAN LOUIS FAURE 240 MM PR ARTERE UTERINE

P184410 JEAN LOUIS FAURE GYNECO FORCEPS 240 MM FOR UTERINE ARTERY

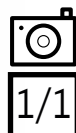

PINCE GYNECO MIKULICZ 200 MM
COURBE A GRIFFES

P184418 MIKULICZ GYNECO FORCEPS 200 MM
CURVED WITH TEETH



PINCE GYNECO MIKULICZ 210 MM
COURBE A GRIFFES A VIS

P184419 MIKULICZ GYNECO FORCEPS 210 MM
CURVED WITH TEETH WITH SCREW

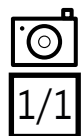

PINCE GYNECO

GYNECO FORCEPS

PINCE GYNECO MUSEUX 7 x 240 MM

P184420 MUSEUX GYNECO FORCEPS 7 X 240 MM

PINCE GYNECO MUSEUX 240 MM FORTE 6 GRIFFES

P184423 MUSEUX GYNECO FORCEPS 240 MM STRONG 6 TEETH



P184421
9 X 240 MM

P184422
11 X 240 MM

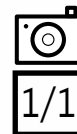
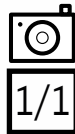

PINCE GYNECO MUSEUX PALMER 4,5 x 235 MM
COUDEE CHERON

P184425 MUSEUX PALMER GYNECO FORCEPS
4,5 X 235 MM ANGLED CHERON

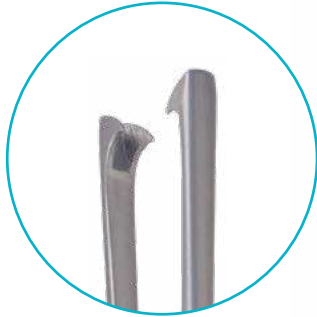

P184424
4.5 X 235 MM
DROITE
STRAIGHT

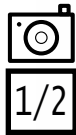

PINCE GYNECO PALMER 220 MM
PR POLYPES

P184426 PALMER GYNECO FORCEPS 220 MM
FOR POLYPS

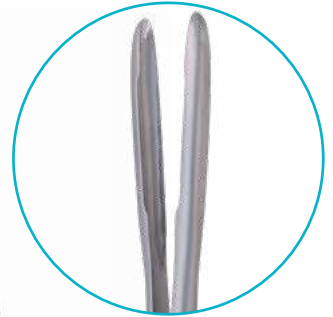

PINCE GYNECO

GYNECO FORCEPS

PINCE GYNECO PHANEUF 220 MM COUDEE

P184427 PHANEUF GYNECO FORCEPS 220 MM ANGLED

PINCE GYNECO PHANEUF 220 MM DROITE

P184428 PHANEUF GYNECO FORCEPS 220 MM STRAIGHT



PINCE GYNECO ROCHARD 210 MM COUDEE
P184435 ROCHARD GYNECO FORCEPS 210 MM ANGLED

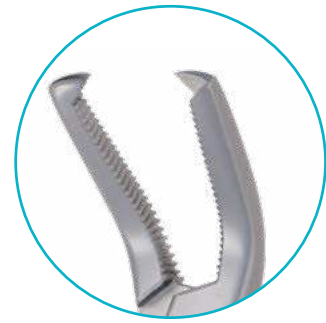

PINCE GYNECO

GYNECO FORCEPS

PINCE GYNECO POZZI 240 MM

P184431 POZZI GYNECO FORCEPS 240 MM

PINCE GYNECO POZZI PALMER
235 MM COUDEE CHERON

P184434 POZZI PALMER GYNECO FORCEPS
235 MM ANGLED CHERON



P184430
180 MM

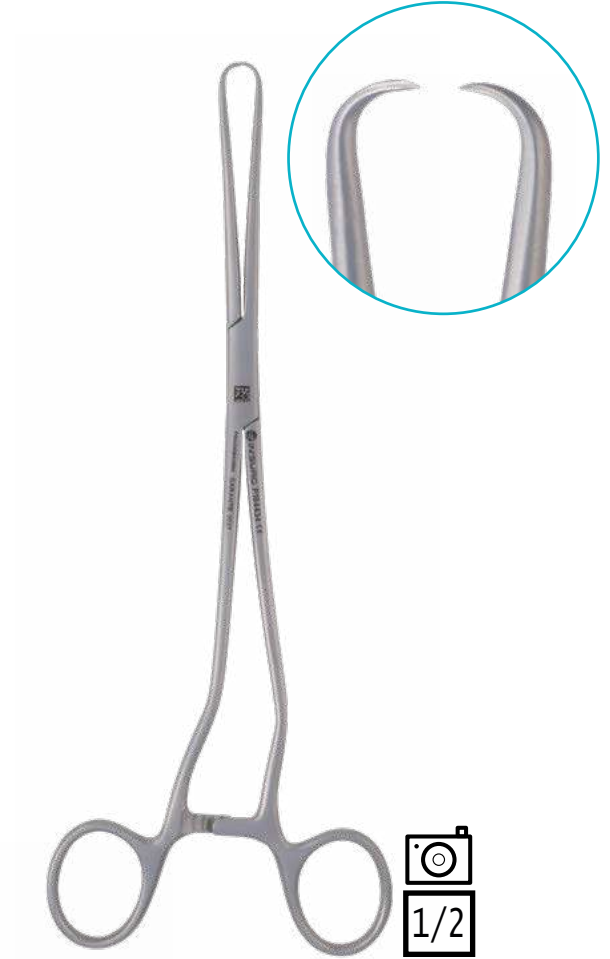

PINCE GYNECO POZZI PALMER 235 MM

P184433 POZZI PALMER GYNECO FORCEPS 235 MM



PINCE GYNECO ROGERS ATRAUMATIQUE 220 MM FIGURE 1

P184436 ROGERS ATRAUMATIC GYNECO FORCEPS 220 MM FIGURE 1

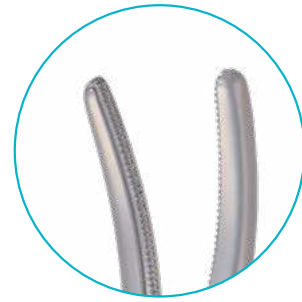

PINCE GYNECO ROGERS ATRAUMATIQUE 240 MM FIGURE 2

P184437 ROGERS ATRAUMATIC GYNECO FORCEPS 240 MM FIGURE 2



PINCE GYNECO ROGERS ATRAUMATIQUE 260 MM FIGURE 3

P184438 ROGERS ATRAUMATIC GYNECO FORCEPS 260 MM FIGURE 3



PINCE GYNECO ROGERS ATRAUMATIQUE 240 MM FIGURE 4

P184438 ROGERS ATRAUMATIC GYNECO FORCEPS 240 MM FIGURE 4



PINCE GYNECO

GYNECO FORCEPS

PINCE GYNECO SCHROEDER 250 MM COURBE
P184442 *SCHROEDER GYNECO FORCEPS
250 MM CURVED*

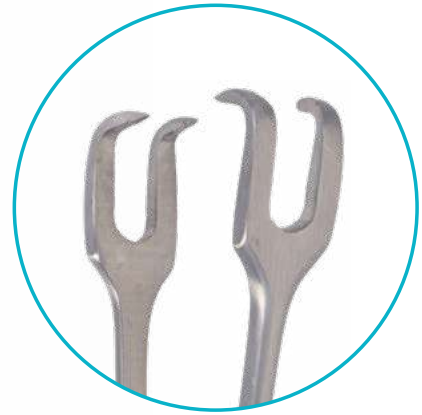

P184443
DROITE
STRAIGHT

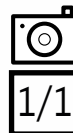

PINCE GYNECO SAENGER 270 MM COURBE
PR FAUX GERMES

P184440 SAENGER GYNECO FORCEPS 270 MM CURVED
FOR OVUM



P184441
DROITE
STRAIGHT



PINCE GYNECO

GYNECO FORCEPS

PINCE GYNECO SKENE 245 MM

P184445 SKENE GYNECO FORCEPS 245 MM

PINCE GYNECO 255 MM COURBE PR STERILET

P184446 GYNECO FORCEPS 255 MM FOR PREHENSION OF THE COIL



PINCE GYNECO THERRUM 270 MM PR STERILET

P184447 *THERRUM GYNECO FORCEPS 270 MM
FOR PREHENSION OF THE COIL*

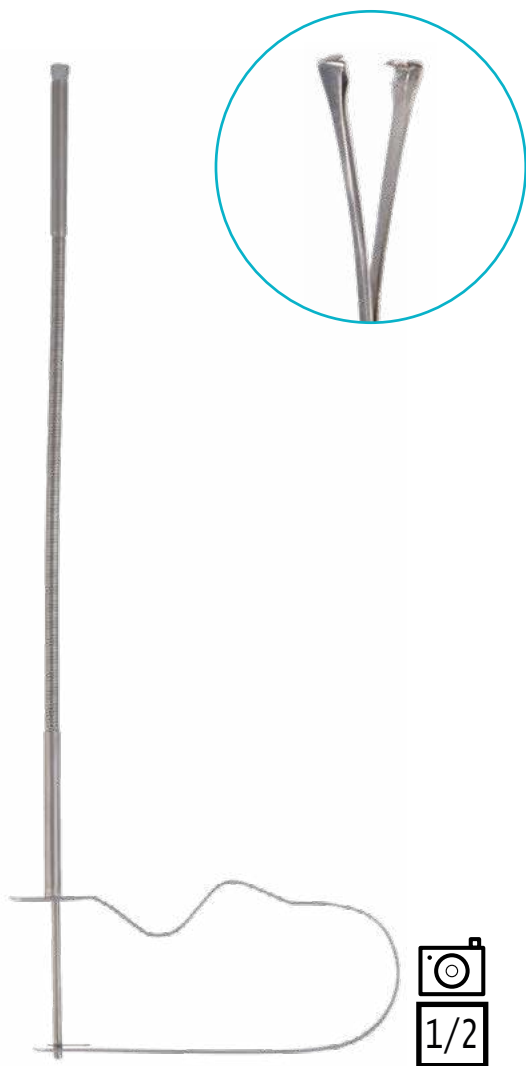

PINCE GYNECO TEALE 230 MM POUR
ABAISSEMENT DU COL DE L'UTERUS

P184448 *TEALE GYNECO FORCEPS 230 MM
VULSELLUM*



PINCE GYNECO

GYNECO FORCEPS

PINCE GYNECO WERTHEIM
230 MM COURBE A GRIFFES

P184449 WERTHEIM GYNECO FORCEPS
230 MM CURVED WITH TEETH

PINCE GYNECO WERTHEIM 250 MM
COURBE SANS GRIFFE

P184450 WERTHEIM GYNECO FORCEPS 250 MM
CURVED WITHOUT TEETH

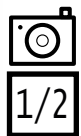
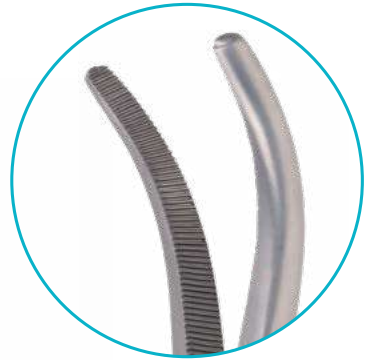

PINCE GYNECO WINTER 280 MM COURBE GRAND MODELE VIS INOX

P184451 WINTER GYNECO FORCEPS 280 MM CURVED LARGE MODELE WITH SCREW STAINLESS STEEL



PETIT MODELE
SMALL MODELE



MOYEN MODELE
MEDIUM MODELE



GRAND MODELE
LARGE MODELE

COURBE
CURVED

P184455

P184453

P184451

DROITE
STRAIGHT

P184456

P184454

P184452

PINCE HEMOSTATIQUE

HEMOSTATIC FORCEPS

PINCE HEMOSTATIQUE ADSON
180 MM COURBE MORS KELLY

P194459 ADSON HEMOSTATIC FORCEPS
180 MM CURVED KELLY JAWS

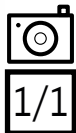

PINCE HEMOSTATIQUE ADSON
180 MM DROITE MORS KELLY

P194460 ADSON HEMOSTATIC FORCEPS
180 MM STRAIGHT KELLY JAWS

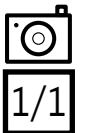

PINCE HEMOSTATIQUE BENGOLEA 210 MM COURBE A GRIFFES

P194462 BENGOLEA HEMOSTATIC FORCEPS 210 MM CURVED WITH TEETH

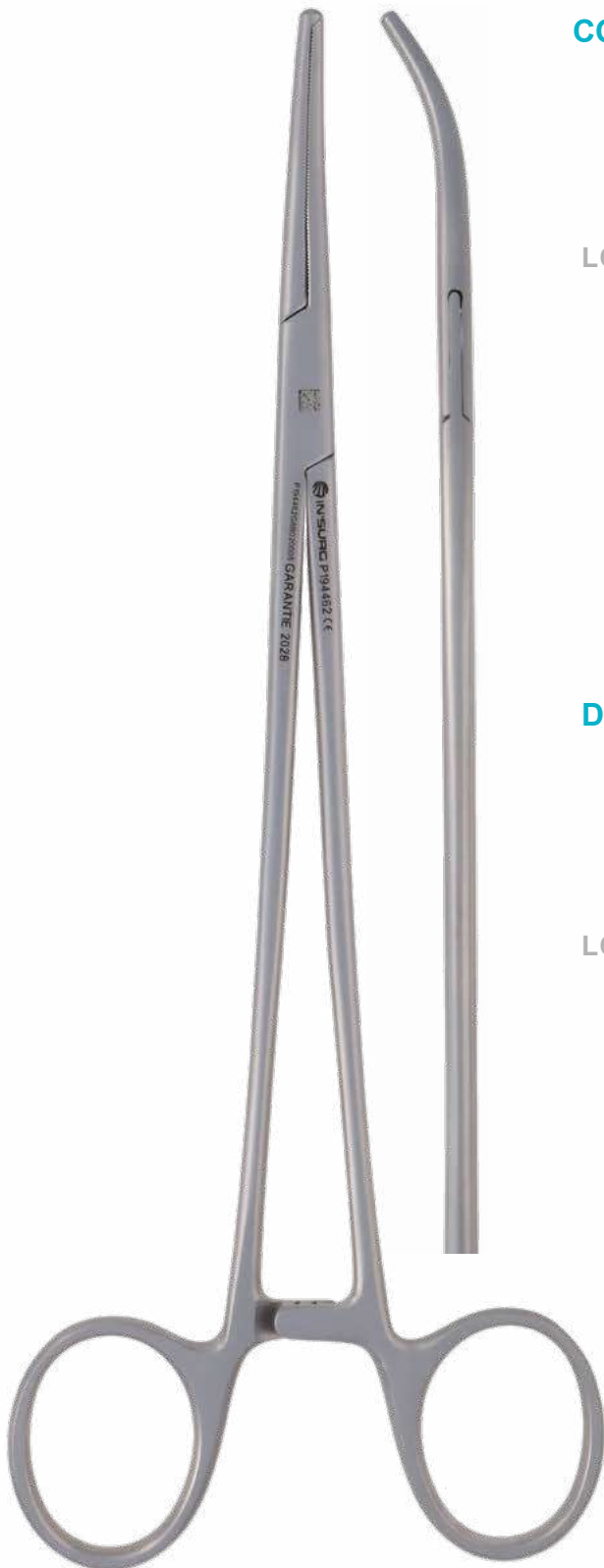

COURBE
CURVED

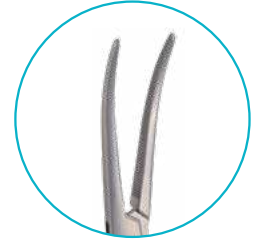

A GRIFFES
WITH TEETH

SANS GRIFFE
WITHOUT TEETH

LONGUEUR
LENGTH

210 MM

P194462

P194463

240 MM

P194467

P194468

300 MM

P194475

P194476

DROITE
STRAIGHT

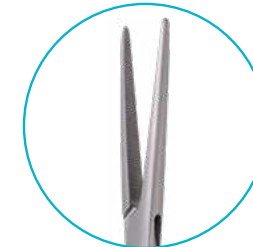

A GRIFFES
WITH TEETH

SANS GRIFFE
WITHOUT TEETH

LONGUEUR
LENGTH

210 MM

P194465

P194466

240 MM

P194469

P194470

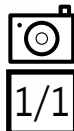

PINCE HEMOSTATIQUE BENGOLEA 240 MM FINE COURBE A GRIFFES ULTRA LINE

P194471 ULTRA LINE BENGOLEA HEMOSTATIC FORCEPS 240 MM FINE CURVED WITH TEETH



Garantie totale
10 ANS
sans conditions



A GRIFFES
WITH TEETH



SANS GRIFFE
WITHOUT TEETH

MODELE FIN
BENT MODEL



P194471

P194472

MODELE FORT
STRONG MODEL



P194473

P194474

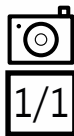

PINCE HEMOSTATIQUE BENGOLEA 210 MM COURBE SANS GRIFFE ULTRA LINE

P194464 *ULTRA LINE BENGOLEA HEMOSTATIC FORCEPS 210 MM CURVED WITHOUT TEETH*

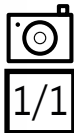

PINCE HEMOSTATIQUE

HEMOSTATIC FORCEPS

PINCE HEMOSTATIQUE BENGOLEA SUEDOISE 240 MM COURBE A GRIFFES ULTRA LINE

P194477 ULTRA LINE BENGOLEA SUEDOISE HEMOSTATIC FORCEPS 240 MM CURVED WITH TEETH



A GRIFFES
WITH TEETH



SANS GRIFFE
WITHOUT TEETH

LONGUEUR
LENGTH

240 MM

P194477

P194478



PINCE HEMOSTATIQUE CHRISTOPHE 160 MM COURBE A GRIFFES

P194483 CHRISTOPHE HEMOSTATIC FORCEPS 160 MM CURVED WITH TEETH

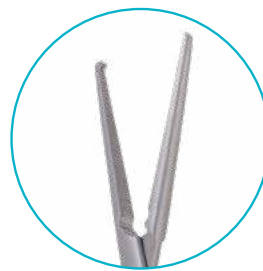
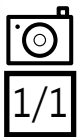

COURBE
CURVED

DROITE
STRAIGHT

LONGUEUR
LENGTH

A GRIFFES
WITH TEETH

SANS GRIFFE
WITHOUT TEETH

A GRIFFES
WITH TEETH

SANS GRIFFE
WITHOUT TEETH

160 MM

P194483

P194484

P194485

P194486

PINCE HEMOSTATIQUE CHRISTOPHE 160 MM COURBE A GRIFFES ULTRA LINE
P194479 ULTRA LINE CHRISTOPHE HEMOSTATIC FORCEPS 160 MM CURVED WITH TEETH



COURBE
 CURVED



A GRIFFES
 WITH TEETH

SANS GRIFFE
 WITHOUT TEETH

LONGUEUR
 LENGTH

160 MM

P194479

P194480

DROITE
 CURVED

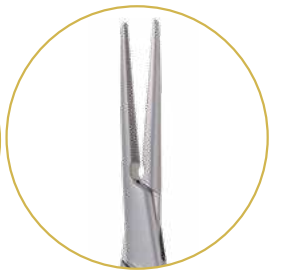
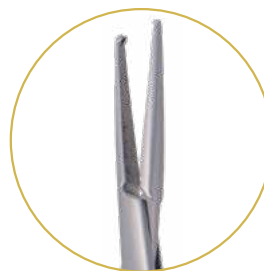

A GRIFFES
 WITH TEETH

SANS GRIFFE
 WITHOUT TEETH

LONGUEUR
 LENGTH

160 MM

P194481

P194482

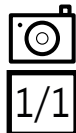

PINCE HEMOSTATIQUE CRAFOORD 240 MM
COURBE

P194488 CRAFOORD HEMOSTATIC FORCEPS
240 MM CURVED

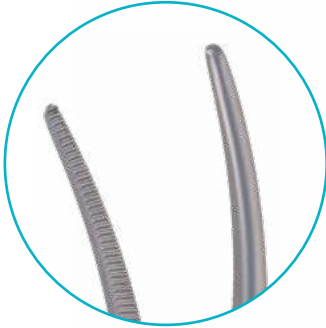

PINCE HEMOSTATIQUE DANDY 140 MM COURBE
P194494 DANDY HEMOSTATIC FORCEPS 140 MM CURVED



P194493
120 MM



PINCE HEMOSTATIQUE

HEMOSTATIC FORCEPS

PINCE HEMOSTATIQUE DEBAKEY 240 MM COURBE ULTRA LINE

P194495 ULTRA LINE DEBAKEY HEMOSTATIC FORCEPS 240 MM CURVED



P194496
290 MM



PINCE HEMOSTATIQUE CRILE 160 MM COURBE SANS GRIFFE

P194490 CRILE HEMOSTATIC FORCEPS 160 MM CURVED WITHOUT TEETH



LONGUEUR
LENGTH

140 MM

160 MM

COURBE
CURVED

DROITE
STRAIGHT

P194489

P194490

P194492



PINCE HEMOSTATIQUE DELORE 130 MM COURBE

P194497 DELORE HEMOSTATIC FORCEPS 130 MM CURVED

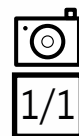

PINCE HEMOSTATIQUE

HEMOSTATIC FORCEPS

PINCE HEMOSTATIQUE CRILE 160 MM COURBE SANS GRIFFE ULTRA LINE

P194491 *ULTRA LINE CRILE HEMOSTATIC FORCEPS 160 MM CURVED WITHOUT TEETH* IN'SURG
ULTRA LINE

Garantie
totale
10 ANS
sans conditions



PINCE HEMOSTATIQUE DEMARTEL 140 MM EN T
P194498 DEMARTEL HEMOSTATIC FORCEPS
140 MM T FORM



PINCE HEMOSTATIQUE DESJARDINS 210 MM
PR CANAL CYSTIQUE
P194499 DESJARDINS HEMOSTATIC FORCEPS
210 MM FOR THE CYSTIC CANAL

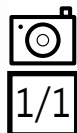

PINCE HEMOSTATIQUE

HEMOSTATIC FORCEPS

PINCE HEMOSTATIQUE DIXON LOVELACE 155 MM DROITE A GRIFFES

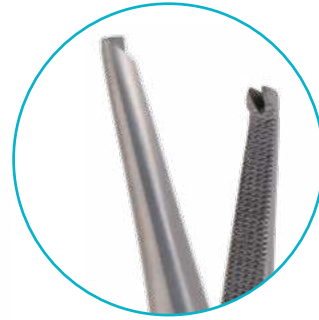
P194501 *DIXON LOVELACE HEMOSTATIC FORCEPS 155 MM STRAIGHT WITH TEETH*

PINCE HEMOSTATIQUE GRAY 220 MM EN S
PR CANAL CYSTIQUE

P194502 GRAY HEMOSTATIC FORCEPS 220 MM
S FORM FOR THE CYSTIC CANAL

PINCE HEMOSTATIQUE GRAY 230 MM EN S
PR CANAL CYSTIQUE

P194503 GRAY HEMOSTATIC FORCEPS 230 MM
S FORM FOR THE CYSTIC CANAL



PINCE HEMOSTATIQUE

HEMOSTATIC FORCEPS

PINCE HEMOSTATIQUE GUYON 230 MM
PR PEDICULE RENALE

P194506 GUYON HEMOSTATIC FORCEPS 230 MM
FOR KIDNEY PEDICLE

PINCE HEMOSTATIQUE GUYON 230 MM
GRANDE COURBURE PR PEDICULE RENALE

P194507 GUYON HEMOSTATIC FORCEPS
230 MM LARGE CURVATURE FOR
KIDNEY PEDICLE

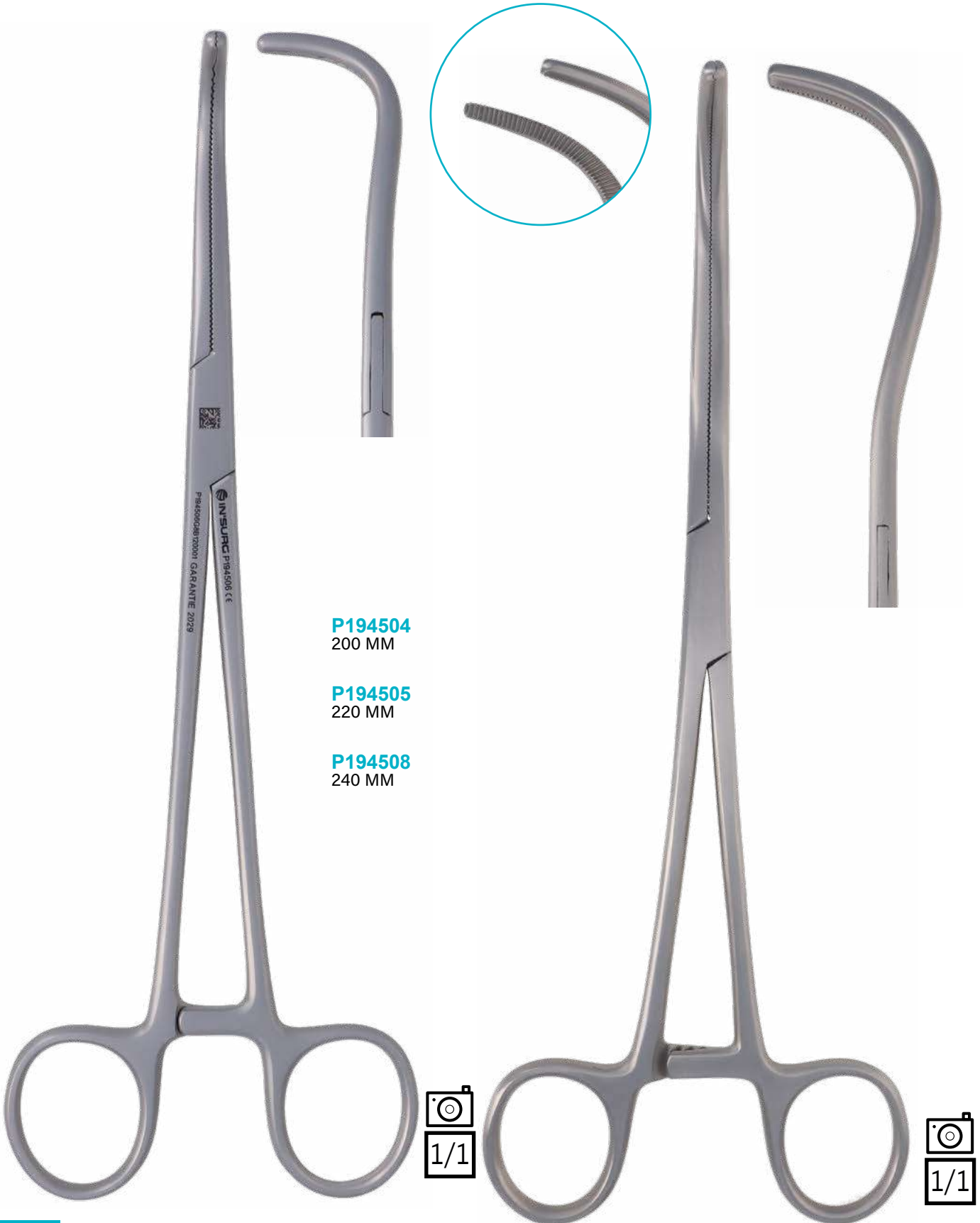

P194504
200 MM

P194505
220 MM

P194508
240 MM

PINCE HEMOSTATIQUE HALSTEAD 100 MM COURBE A GRIFFES

P194509 HALSTEAD HEMOSTATIC FORCEPS 100 MM CURVED WITH TEETH



COURBE
CURVED



A GRIFFES
WITH TEETH



SANS GRIFFE
WITHOUT TEETH

LONGUEUR
LENGTH

100 MM

P194509

P194510

120 MM

P194514

P194516

DROITE
STRAIGHT



A GRIFFES
WITH TEETH



SANS GRIFFE
WITHOUT TEETH

LONGUEUR
LENGTH

100 MM

P194512

P194513

120 MM

P194519

P194521

PINCE HEMOSTATIQUE

HEMOSTATIC FORCEPS

PINCE HEMOSTATIQUE HALSTEAD 120 MM MICRO COURBE A GRIFFES

P194523 HALSTEAD HEMOSTATIC FORCEPS 120 MM MICRO CURVED WITH TEETH

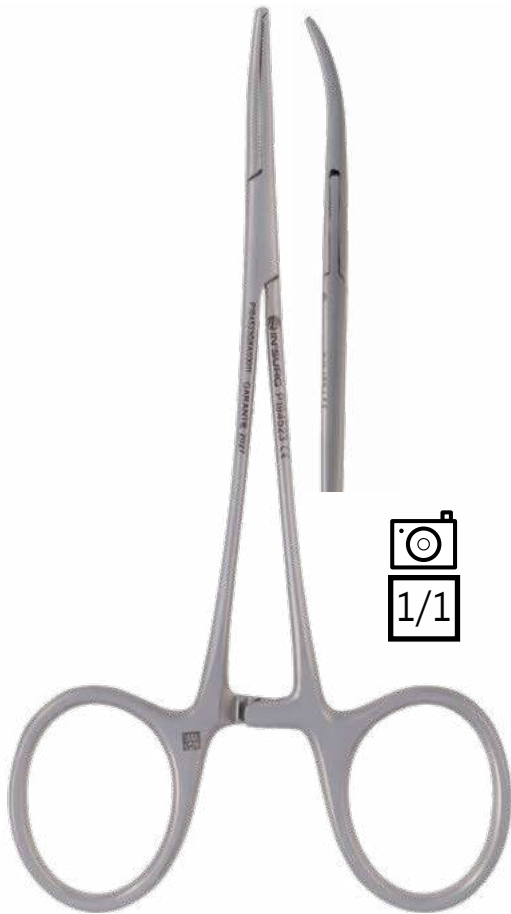

COURBE
CURVED



LONGUEUR
LENGTH
120 MM

A GRIFFES
WITH TEETH

SANS GRIFFE
WITHOUT TEETH

P194523

P194524

DROITE
STRAIGHT

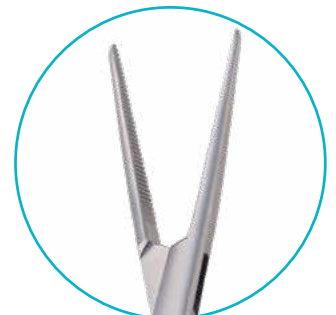

LONGUEUR
LENGTH
120 MM

A GRIFFES
WITH TEETH

SANS GRIFFE
WITHOUT TEETH

P194525

P194526

PINCE HEMOSTATIQUE HALSTEAD 120 MM COURBE SANS GRIFFE ISOLEE

P194518 HALSTEAD HEMOSTATIC FORCEPS 120 MM CURVED WITHOUT TEETH INSULATED



PINCE HEMOSTATIQUE HALSTEAD 120 MM COURBE A GRIFFES ULTRA LINE

P194515 ULTRA LINE HALSTEAD HEMOSTATIC FORCEPS 120 MM CURVED WITH TEETH

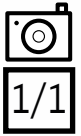
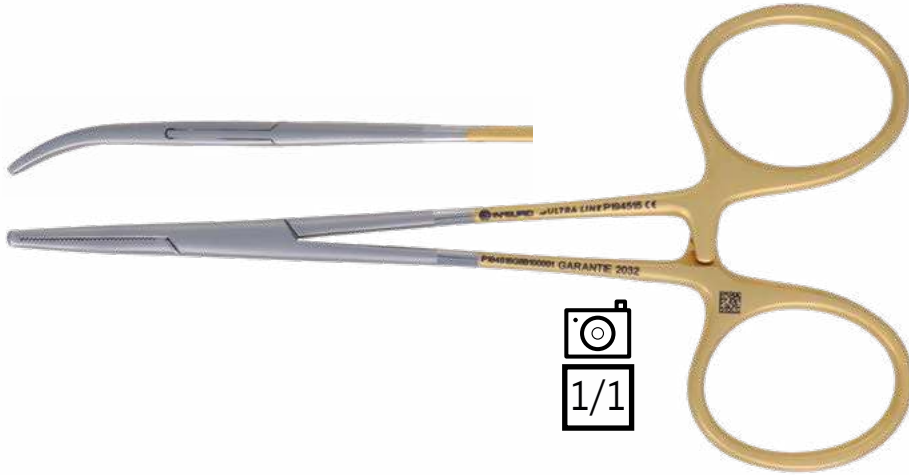

COURBE
CURVED



A GRIFFES
WITH TEETH

SANS GRIFFE
WITHOUT TEETH

LONGUEUR
LENGTH

100 MM

P194511

120 MM

P194515

P194517

DROITE
CURVED



A GRIFFES
WITH TEETH

SANS GRIFFE
WITHOUT TEETH

LONGUEUR
LENGTH

120 MM

P194520

P194522

PINCE HEMOSTATIQUE HALSTEAD MICRO 120 MM COURBE A GRIFFES ULTRA LINE

P194529 ULTRA LINE MICRO HALSTEAD HEMOSTATIC FORCEPS 120 MM CURVED WITH TEETH



Garantie totale
10 ANS
sans conditions



COURBE
CURVED



A GRIFFES
WITH TEETH

P194529



SANS GRIFFE
WITHOUT TEETH

P194530

LONGUEUR
LENGTH
120 MM

DROITE
CURVED



A GRIFFES
WITH TEETH

P194531



SANS GRIFFE
WITHOUT TEETH

P194532

LONGUEUR
LENGTH
120 MM

PINCE HEMOSTATIQUE
HALSTEAD 120 MM COURBE MORS
DEBAKEY ATRAUMATIQUE

P194457 HALSTEAD HEMOSTATIC FORCEPS
120 MM CURVED DEBAKEY JAWS
ATRAUMATIC



PINCE HEMOSTATIQUE
HALSTEAD 120 MM DROITE MORS
DEBAKEY ATRAUMATIQUE

P194458 HALSTEAD HEMOSTATIC FORCEPS
120 MM STRAIGHT DEBAKEY JAWS
ATRAUMATIC



PINCE HEMOSTATIQUE

HEMOSTATIC FORCEPS

PINCE HEMOSTATIQUE KANTROWITZ 190 MM COURBE

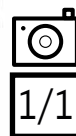
P194534 KANTROWITZ HEMOSTATIC FORCEPS 190 MM CURVED

PINCE HEMOSTATIQUE KELLY 140 MM COURBE A GRIFFES
P194535 KELLY HEMOSTATIC FORCEPS 140 MM CURVED WITH TEETH



COURBE
 CURVED



A GRIFFES
 WITH TEETH



SANS GRIFFE
 WITHOUT TEETH

LONGUEUR
 LENGTH

- 140 MM
- 150 MM
- 160 MM
- 180 MM
- 210 MM

- P194535**
- P194539**
- P194546**
- P194550**

- P194536**
- P194541**
- P194547**
- P194551**

DROITE
 STRAIGHT



A GRIFFES
 WITH TEETH



SANS GRIFFE
 WITHOUT TEETH

LONGUEUR
 LENGTH

- 140 MM
- 150 MM
- 160 MM
- 180 MM
- 210 MM

- P194537**
- P194540**
- P194548**
- P194552**

- P194538**
- P194544**
- P194549**
- P194553**

PINCE HEMOSTATIQUE

HEMOSTATIC FORCEPS

PINCE HEMOSTATIQUE KELLY 160 MM
COURBE SANS GRIFFE ISOLEE

P194543 KELLY HEMOSTATIC FORCEPS
160 MM CURVED WITHOUT
TEETH INSULATED



PINCE HEMOSTATIQUE KELLY 160 MM COURBE
SANS GRIFFE ULTRA LINE

P194542 ULTRA LINE KELLY HEMOSTATIC FORCEPS 160 MM
CURVED WITHOUT TEETH

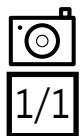

IN'SURG
ULTRA LINE



P194545
160 MM
DROITE
STRAIGHT

PINCE HEMOSTATIQUE KELLY RANKIN 160 MM
COURBE SANS GRIFFE ULTRA LINE

P194554 *ULTRA LINE KELLY RANKIN HEMOSTATIC
FORCEPS 160 MM CURVED WITHOUT TEETH*



PINCE HEMOSTATIQUE KELLY RANKIN 160 MM
COURBE SANS GRIFFE

P194643 *HEMOSTATIC CLAMP KELLY RANKIN
160 MM CURVE WITHOUT TEETH*



P194555
160 MM
DROITE
STRAIGHT

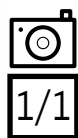

P194644
160 MM
DROITE
STRAIGHT

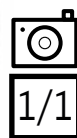

PINCE HEMOSTATIQUE

HEMOSTATIC FORCEPS

PINCE HEMOSTATIQUE KOCHER 140 MM COURBE A GRIFFES

P194556 KOCHER HEMOSTATIC FORCEPS 140 MM CURVED WITH TEETH



COURBE
CURVED



A GRIFFES
WITH TEETH

SANS GRIFFE
WITHOUT TEETH

LONGUEUR
LENGTH

140 MM

P194556

P194557

150 MM

P194560

P194561

180 MM

P194564

P194565

210 MM

P194568

P194569

240 MM

P194572

P194573

DROITE
STRAIGHT



A GRIFFES
WITH TEETH

SANS GRIFFE
WITHOUT TEETH

LONGUEUR
LENGTH

140 MM

P194558

P194559

150 MM

P194562

P194563

180 MM

P194566

P194567

210 MM

P194570

P194571

240 MM

P194574

P194575

PINCE HEMOSTATIQUE LAHEY 190 MM COURBE
PR VOIES BILIAIRES

P194576 LAHEY HEMOSTATIC FORCEPS 190 MM CURVED
FOR BILE DUCTS

PINCE HEMOSTATIQUE PEAN 140 MM
COURBE ATRAUMATIQUE

P194609 PEAN ATRAUMATIC HEMOSTATIC
FORCEPS 140 MM CURVED



P194577
230 MM

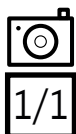

PINCE HEMOSTATIQUE

HEMOSTATIC FORCEPS

PINCE HEMOSTATIQUE NEGUS 200 MM
GRANDE COURBURE

P194607 *NEGUS HEMOSTATIC FORCEPS
200 MM LARGE CURVATURE*

PINCE HEMOSTATIQUE NEGUS 200 MM
PETITE COURBURE

P194608 *NEGUS HEMOSTATIC
FORCEPS 200 MM SMALL
CURVATURE*



PINCE HEMOSTATIQUE LERICHE 150 MM COURBE A GRIFFES

P194578 LERICHE HEMOSTATIC FORCEPS 150 MM CURVED WITH TEETH



COURBE
CURVED

LONGUEUR
LENGTH

150 MM

180 MM

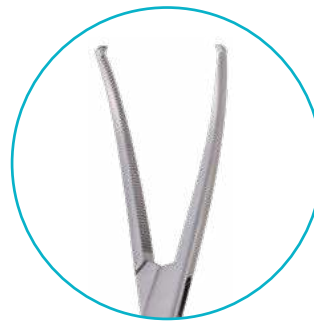

A GRIFFES
WITH TEETH

P194578

P194590



SANS GRIFFE
WITHOUT TEETH

P194580

P194592

DROITE
STRAIGHT

LONGUEUR
LENGTH

150 MM

180 MM



A GRIFFES
WITH TEETH

P194582

P194594

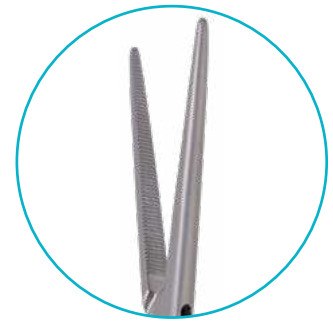

SANS GRIFFE
WITHOUT TEETH

P194584

P194596

PINCE HEMOSTATIQUE LERICHE 180 MM COURBE A GRIFFES ULTRA LINE

P194591 ULTRA LINE LERICHE HEMOSTATIC FORCEPS 180 MM CURVED WITH TEETH



Garantie totale
10 ANS
sans conditions

COURBE
CURVED



A GRIFFES
WITH TEETH



SANS GRIFFE
WITHOUT TEETH

LONGUEUR
LENGTH

150 MM
160 MM
180 MM

P194579
P194586
P194591

P194581
P194587
P194593

DROITE
CURVED



A GRIFFES
WITH TEETH



SANS GRIFFE
WITHOUT TEETH

LONGUEUR
LENGTH

150 MM
160 MM
180 MM

P194583
P194588
P194595

P194585
P194589
P194597



PINCE HEMOSTATIQUE LERICHE ERGONOMIC 180 MM COURBE A GRIFFES ULTRA LINE
P194598 ULTRA LINE LERICHE ERGONOMIC HEMOSTATIC FORCEPS 180 MM CURVED WITH TEETH



Garantie totale
10 ANS
 sans conditions

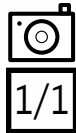

COURBE
 CURVED



A GRIFFES
 WITH TEETH



SANS GRIFFE
 WITHOUT TEETH

LONGUEUR
 LENGTH

180 MM

P194598

P194599

DROITE
 CURVED



A GRIFFES
 WITH TEETH



SANS GRIFFE
 WITHOUT TEETH

LONGUEUR
 LENGTH

180 MM

P194600

P194601

PINCE HEMOSTATIQUE LERICHE SUEDOISE 140 MM COURBE A GRIFFES ULTRA LINE

P194602 ULTRA LINE LERICHE SUEDOISE HEMOSTATIC FORCEPS 140 MM CURVED WITH TEETH



Garantie totale
10 ANS
sans conditions



A GRIFFES
WITH TEETH



SANS GRIFFE
WITHOUT TEETH

LONGUEUR
LENGTH
140 MM

P194602

P194603



PINCE HEMOSTATIQUE MOYNIHAN 240 MM
COURBE VASCULAIRE

P194606 MOYNIHAN HEMOSTATIC FORCEPS 240 MM
CURVED VASCULAR

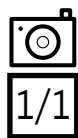

PINCE HEMOSTATIQUE MOYNIHAN 230 MM
COURBE

P194605 MOYNIHAN HEMOSTATIC FORCEPS
230 MM CURVED

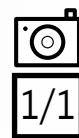

PINCE HEMOSTATIQUE

HEMOSTATIC FORCEPS

PINCE HEMOSTATIQUE POZZI 200 MM EN T

P194610 POZZI HEMOSTATIC FORCEPS
200 MM T FORM

PINCE HEMOSTATIQUE PRATT SMITH 160 MM

P194611 PRATT SMITH HEMOSTATIC
FORCEPS 160 MM

PINCE HEMOSTATIQUE PROVIDENCE HOSPITAL 140 MM COURBE SANS GRIFFE
P194612 PROVIDENCE HOSPITAL HEMOSTATIC FORCEPS 140 MM CURVED WITHOUT TEETH



LONGUEUR
LENGTH

140 MM

COURBE
CURVED

P194612

DROITE
STRAIGHT

P194613



PINCE HEMOSTATIQUE

HEMOSTATIC FORCEPS

PINCE HEMOSTATIQUE ROCHESTER CARMALT 160 MM COURBE

P194614 ROCHESTER CARMALT HEMOSTATIC FORCEPS 160 MM CURVED

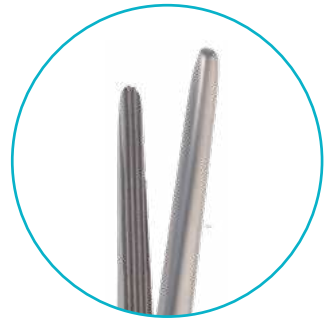

LONGUEUR
LENGTH

160 MM

200 MM

COURBE
CURVED

DROITE
STRAIGHT

P194614

P194615

P194616

P194617

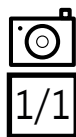

PINCE HEMOSTATIQUE ROCHESTER PEAN 160 MM COURBE
P194618 ROCHESTER PEAN HEMOSTATIC FORCEPS 160 MM CURVED

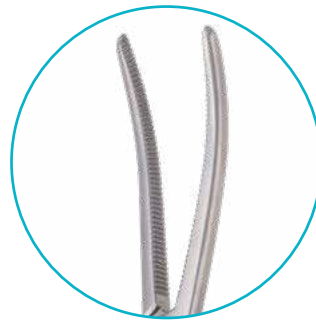

LONGUEUR
 LENGTH

- 160 MM
- 180 MM
- 200 MM
- 240 MM
- 260 MM

COURBE
 CURVED

DROITE
 STRAIGHT

- P194618**
- P194620**
- P194623**
- P194625**
- P194627**

- P194619**
- P194622**
- P194624**
- P194626**

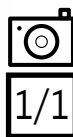

PINCE HEMOSTATIQUE ROCHESTER PEAN 180 MM COURBE ULTRA LINE

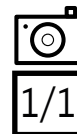
P194621 *ULTRA LINE ROCHESTER PEAN HEMOSTATIC FORCEPS 180 MM CURVED*

PINCE HEMOSTATIQUE SANTY 240 MM
COURBE SANS GRIFFE

P194630 *SANTY HEMOSTATIC FORCEPS
240 MM CURVED WITHOUT TEETH*



P194632
300 MM

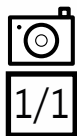

PINCE HEMOSTATIQUE SANTY 240 MM COURBE
SANS GRIFFE ULTRA LINE

P194631 *ULTRA LINE SANTY HEMOSTATIC FORCEPS
240 MM CURVED WITHOUT TEETH*



P194633
300 MM

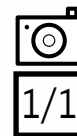

IN'SURG
ULTRA LINE

Garantie
totale
10 ANS
sans conditions

PINCE HEMOSTATIQUE

HEMOSTATIC FORCEPS

PINCE HEMOSTATIQUE SAROT 240 MM COURBE SANS GRIFFE

P194634 SAROT HEMOSTATIC FORCEPS 240 MM CURVED WITHOUT TEETH

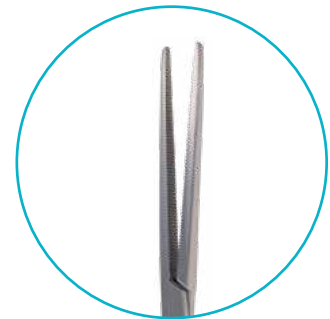
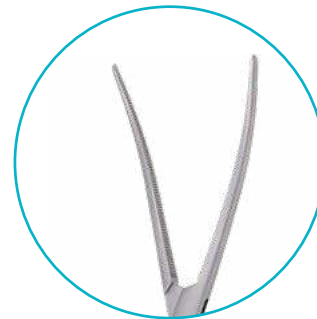

LONGUEUR
LENGTH
240 MM

COURBE
CURVED

DROITE
STRAIGHT

P194634

P194635

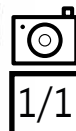

PINCE HEMOSTATIQUE SPENCER WELLS
130 MM DROITE SANS GRIFFE

P194637 SPENCER WELLS HEMOSTATIC FORCEPS
130 MM STRAIGHT WITHOUT TEETH



PINCE HEMOSTATIQUE
TERRIER 120 MM DROITE SANS GRIFFE

P194641 TERRIER HEMOSTATIC FORCEPS 120 MM
STRAIGHT WITHOUT TEETH

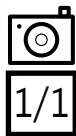

LONGUEUR
LENGTH

COURBE
CURVED

DROITE
STRAIGHT

130 MM

P194636

P194637

150 MM

P194638

P194639

PINCE HEMOSTATIQUE

HEMOSTATIC FORCEPS

PINCE HEMOSTATIQUE STILLE 230 MM PR PEDICULE RENALE

P194640 *STILLE HEMOSTATIC FORCEPS 230 MM FOR KIDNEY PEDICLE*

PINCE HEMOSTATIQUE A BOURSE 42 MM 7 DENTS
P194642 HEMOSTATIC PURSE FORCEPS 42 MM 7 TEETHS



PINCE MENISQUE

MENISCUS FORCEPS

PINCE MENISQUE BIRSCHER 200 MM COURBE
P204642 BIRSCHER MENISCUS FORCEPS
 200 MM CURVED

PINCE MENISQUE HERZ 230 MM ATRAUMATIQUE
 A VERROUILLAGE
P204643 HERZ MENISCUS FORCEPS 230 MM
 ATRAUMATIC INTERLOCKING

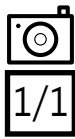

PINCE MENISQUE MARTIN 190 MM DROITE
P204644 MARTIN MENISCUS FORCEPS 190 MM STRAIGHT

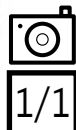

PINCE MENISQUE MUSEUX 140 MM DROITE
P204645 MUSEUX MENISCUS FORCEPS 140 MM STRAIGHT



P204646
180 MM

P204647
200 MM

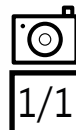

PINCE MENISQUE

MENISCUS FORCEPS

PINCE MENISQUE NICOLLET MUSEUX 160 MM

P204649 *NICOLLET MUSEUX MENISCUS FORCEPS 160 MM*

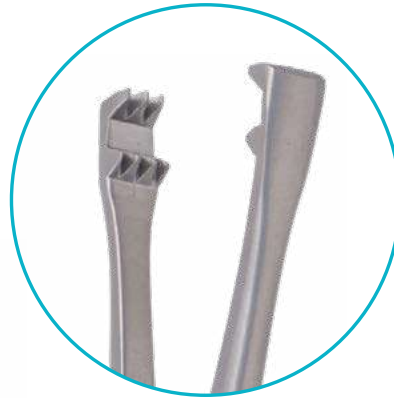

PINCE NEURO MICRO

www.in-surg.fr

P

MICRO NEURO FORCEPS

PINCE NEURO MICRO NICOLA 165 MM MORS PINCES

P214651 *NICOLA MICRO NEURO FORCEPS 165 MM WITH JAWS FORCEPS*

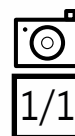

PINCE ONGLES

NAILS FORCEPS

PINCE ONGLES 100 MM INOX
P224652 NAILS FORCEPS 100 MM
 STAINLESS STEEL



P224653
120 MM
P224654
140 MM
P224655
150 MM

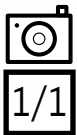

PINCE ONGLES 130 MM PR ONGLE INCARNE INOX
P224658 NAILS FORCEPS 130 MM INGROWN NAILS
 STAINLESS STEEL



P224657
120 MM
P224659
150 MM



PINCE ONGLES 140 MM MORS OBLIQUES INOX
P224656 NAILS FORCEPS 140 MM OBLIQUE
 JAWS STAINLESS STEEL

PINCE ONGLES 130 MM SECATEUR INOX
P224660 NAILS FORCEPS 130 MM CLIPPER STAINLESS STEEL

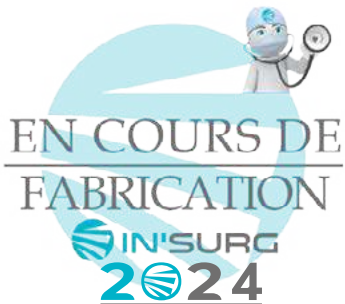

ENT FORCEPS - TONSIL

PINCE O.R.L BOURGEOIS PR AMYGDALES
ANNEAUX DECALES A DOIGT

P234661 BOURGEOIS ENT FORCEPS OFFSET
RINGS DISMOUNTABLE FOR TONSIL

PINCE O.R.L PORTMANN 200 MM PR AMYGDALES
P234669 PORTMANN ENT FORCEPS 200 MM FOR TONSIL

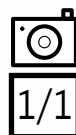
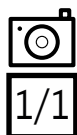

PINCE ORL - AMYGDALES

ENT FORCEPS - TONSIL

PINCE O.R.L SCHNIDT
190 MM FORTE COURBURE PR AMYGDALES

P234673 SCHNIDT ENT FORCEPS 190 MM LARGE
CURVATURE FOR TONSIL

PINCE O.R.L WHITE 180 MM PR AMYGDALES

P234675 WHITE ENT FORCEPS 180 MM FOR TONSIL



P234674
LEGERE COURBURE
SMALL CURVATURE

P234676
230 MM

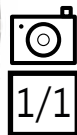

ENT FORCEPS - OTOLOGY

PINCE O.R.L DIETER 3,5 MM COUPE EN BAS PR OTOLOGIE

P234729 DIETER ENT FORCEPS 3,5 MM JAWS POSITION DOWNWARDS FOR OTOLOGY

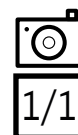
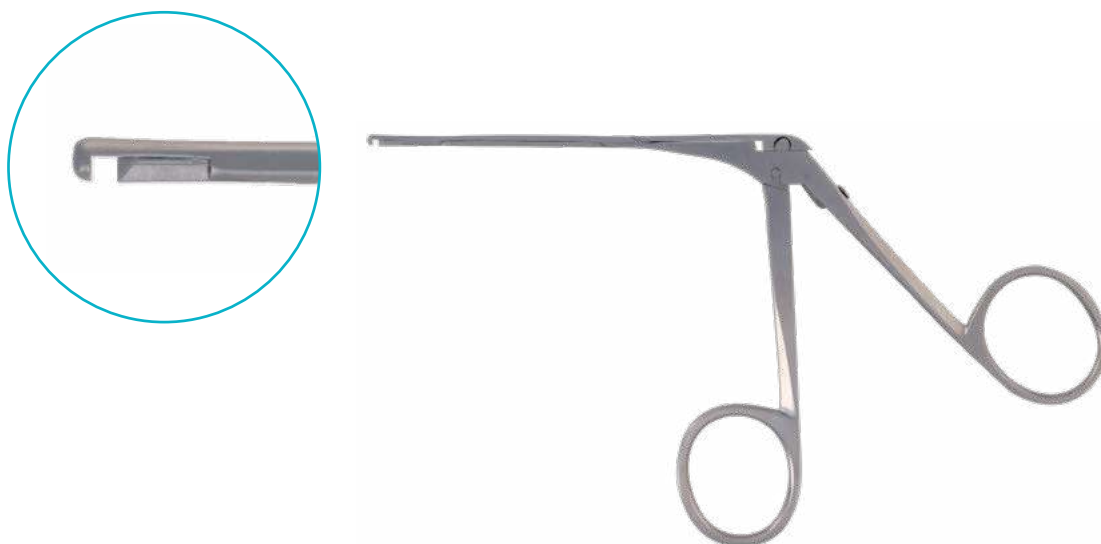

PINCE O.R.L DIETER 3,5 MM COUPE EN HAUT PR OTOLOGIE

P234730 DIETER ENT FORCEPS 3,5 MM JAWS POSITION UPWARDS FOR OTOLOGY

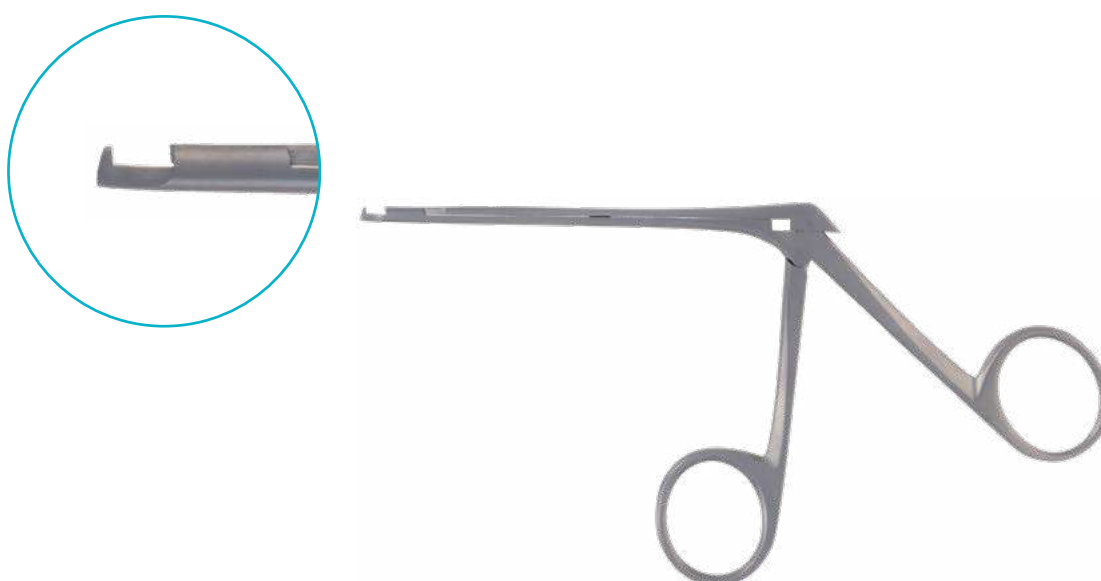

PINCE MICRO O.R.L OTOLOGIE HARTMANN 0,3 X 5,8 X 80 MM MORS STRIES

P234731 HARTMANN MICRO ENT FORCEPS 0,3 X 5,8 X 80 MM SERRATED JAWS OTOLOGY



P234732
0,5 X 4,0 X 80 MM

P234733
0,5 X 4,2 X 80 MM

P234734
0,5 X 6,0 X 80 MM

P234735
1,0 X 4,0 X 80 MM

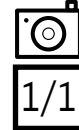
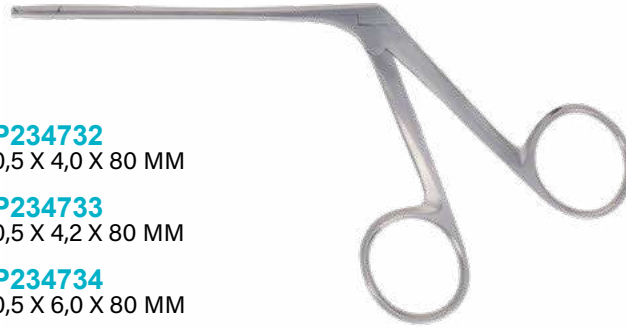

PINCE O.R.L HARTMANN 85 MM A GRIFFES PR OTOLOGIE

P234736 HARTMANN ENT FORCEPS 85 MM WITH TEETH FOR OTOLOGY



A GRIFFES
WITH TEETH

P234739
140 M



SANS GRIFFE
WITHOUT TEETH

P234737
85 MM

P234740
140 MM

P234741
160 MM

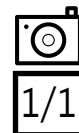

PINCE O.R.L HARTMANN 8 x 125 MM BEC DE CANARD PR OTOLOGIE

P234738 HARTMANN ENT FORCEPS 8 X 125 MM JAWS BEAK OF A DUCK FORM FOR OTOLOGY

PINCE O.R.L 125 MM STRIEE PR OTOLOGIE PANSEMENT

P234742 DRESSING ENT FORCEPS 125 MM SERRATED FOR OTOLOGY

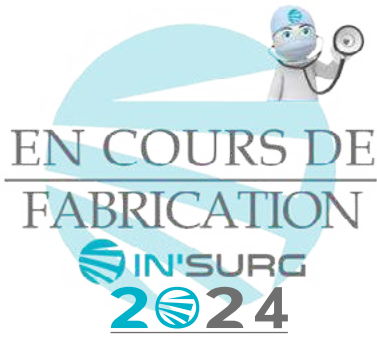

PINCE O.R.L 140 MM A GRIFFES PR OTOLOGIE PANSEMENT

P234743 DRESSING ENT FORCEPS 140 MM WITH TEETH FOR OTOLOGY

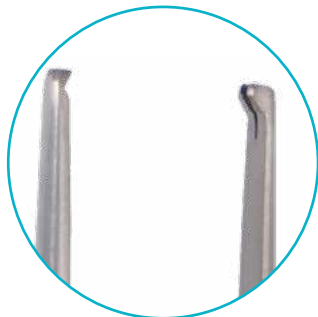

PINCE ORL - OTOLOGIE

ENT FORCEPS - OTOLOGY

PINCE O.R.L LUCAE 160 MM MORS A GRIFFES
PR OTOLOGIE PANSEMENT

P234744 *LUCAE ENT FORCEPS 160 MM
WITH TEETH FOR OTOLOGY
DRESSING*

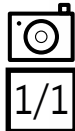
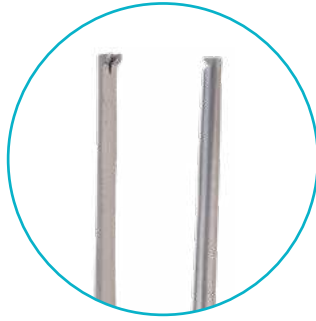

PINCE O.R.L LUCAE 160 MM MORS STRIES
PR OTOLOGIE PANSEMENT

P234745 *LUCAE ENT FORCEPS 160 MM
SERRATED JAWS FOR OTOLOGY
DRESSING*

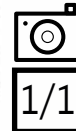

PINCE ORL - RHINOLOGIE

www.in-surg.fr

P

ENT FORCEPS - RHINOLOGY

PINCE O.R.L BRUNNINGS 5 x 190 MM PR RHINOLOGIE

P234748 BRUNNINGS ENT FORCEPS 5 X 190 MM FOR RHINOLOGY



P234749
6 X 190 MM



P234750
8 X 190 MM

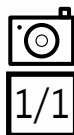

PINCE O.R.L CHATELIER MORS 7 MM A DOIGT PR RHINOLOGIE

P234751 CHATELIER ENT FORCEPS JAWS 7 MM DISMOUNTABLE FOR RHINOLOGY



P234752
10 MM



PINCE O.R.L HARTMANN 5 x 125 MM PR RHINOLOGIE

P234753 HARTMANN ENT FORCEPS 5 X 125 MM FOR RHINOLOGY



P234754
7 X 125 MM

P234755
9 X 125 MM

P234756
11 X 125 MM

PINCE O.R.L HARTMANN STRUYKEN 2 x 125 MM PR RHINOLOGIE
P234763 HARTMANN STRUYKEN ENT FORCEPS 2 X 125 MM FOR RHINOLOGY



PINCE O.R.L KNIGHT 180 MM PR RHINOLOGIE
P234764 KNIGHT ENT FORCEPS 180 MM FOR RHINOLOGY

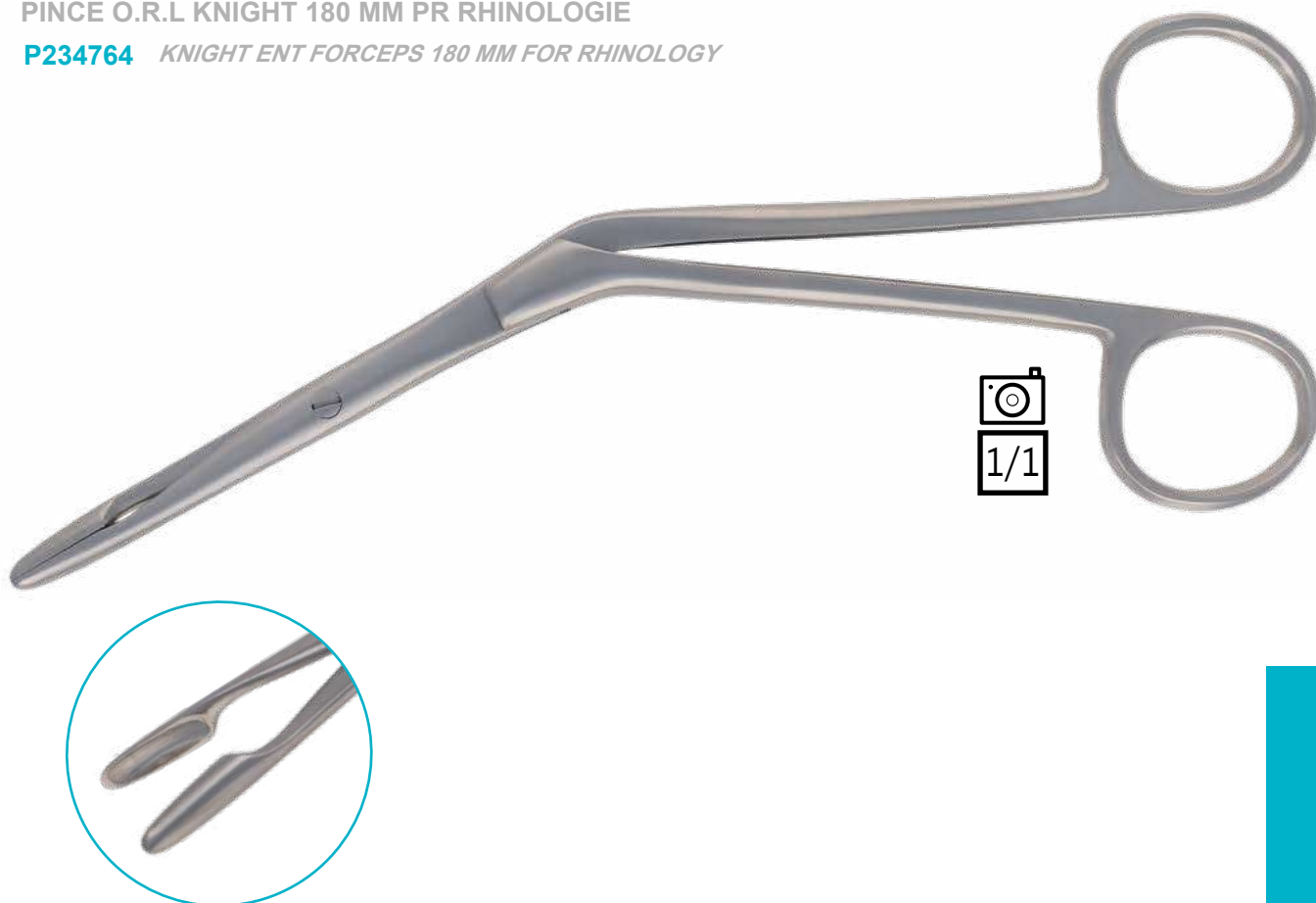

PINCE O.R.L LUC PETITE MORS FENETRES A VIS PR RHINOLOGIE

P234772 LUC ENT FORCEPS SMALL FENESTRATED JAWS WITH SCREW FOR RHINOLOGY



PINCE O.R.L LUC GRANDE MORS FENETRES A VIS PR RHINOLOGIE

P234770 LUC ENT FORCEPS LARGE FENESTRATED JAWS WITH SCREW FOR RHINOLOGY



PINCE O.R.L LUC PETITE MORS PLEINS A VIS PR RHINOLOGIE

P234775 LUC ENT FORCEPS SMALL FULL JAWS WITH SCREW FOR RHINOLOGY

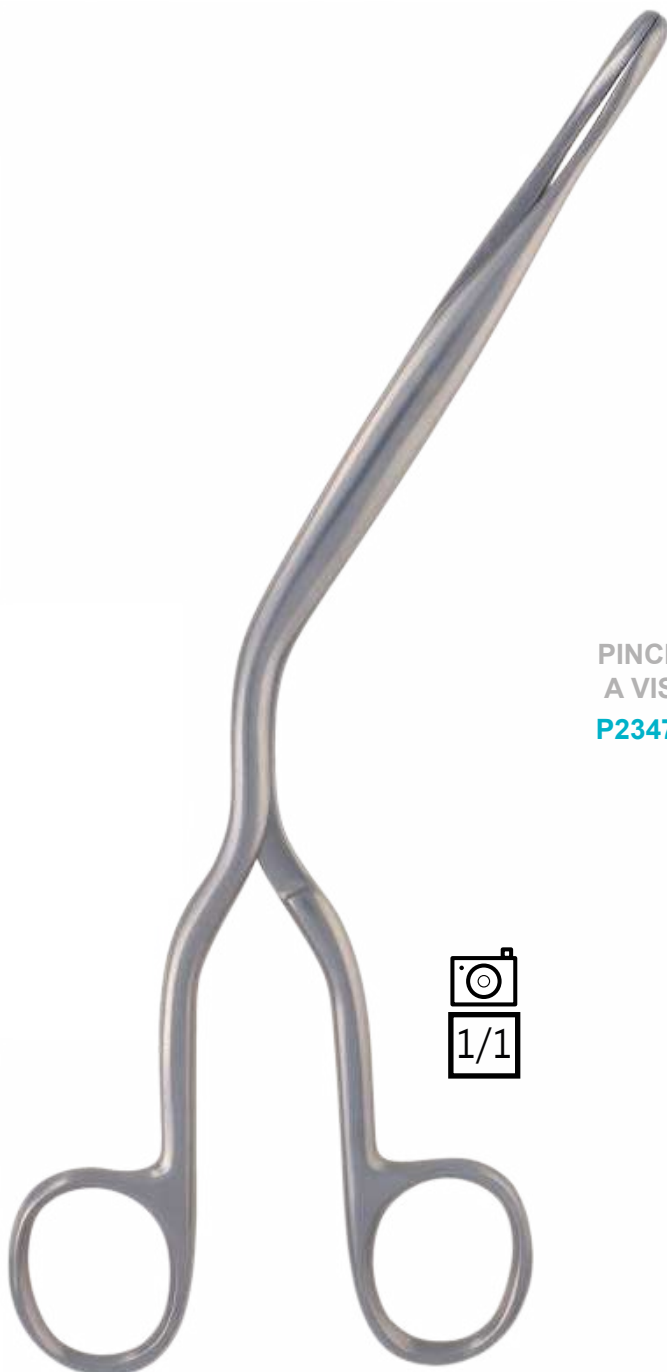

PINCE O.R.L LUC GRANDE MORS PLEINS A VIS PR RHINOLOGIE

P234773 LUC ENT FORCEPS LARGE FULL JAWS WITH SCREW FOR RHINOLOGY



PINCE O.R.L MIDDLETON JASEN 180 MM MORS PLEINS PR RHINOLOGIE

P234779 MIDDLETON JASEN ENT FORCEPS 180 MM FULL JAWS FOR RHINOLOGY



PINCE O.R.L MIDDLETON
JASEN 180 MM MORS AJOURES
PR RHINOLOGIE

P234777 MIDDLETON JASEN ENT FORCEPS
180 MM FENESTRATED JAWS FOR
RHINOLOGY

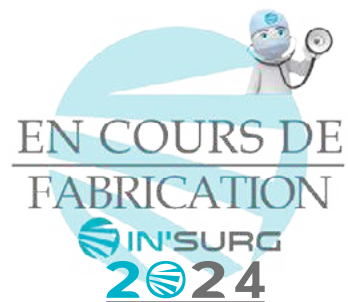

PINCE O.R.L MIDDLETON
JASEN 180 MM MORS CISEAUX
PR RHINOLOGIE

P234778 MIDDLETON JASEN ENT
FORCEPS 180 MM CUTTINGS
JAWS FOR RHINOLOGY

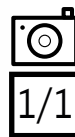
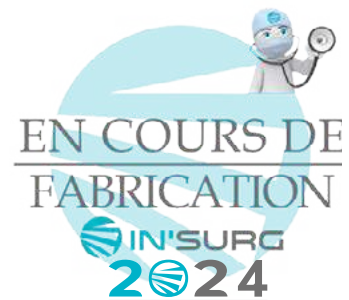

PINCE O.R.L STRUYKEN 1 x 125 MM PR RHINOLOGIE

P234781 STRUYKEN ENT FORCEPS 1 X 125 MM FOR RHINOLOGY

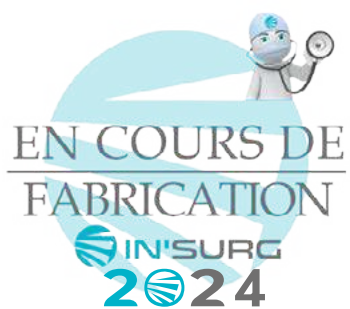

P234782
2 X 125 MM

PINCE O.R.L TAKAHASHI 4 x 125 MM MORS DROITS PR RHINOLOGIE

P234786 TAKAHASHI ENT FORCEPS 4 X 125 MM STRAIGHT JAWS FOR RHINOLOGY

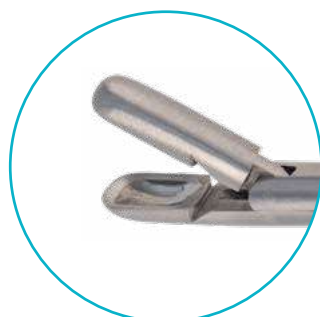

P234785
COUDEE HAUT
HIGH ANGLED



PINCE O.R.L WEIL BLAKESLEY 5 x 125 MM COUDEE HAUT PR RHINOLOGIE

P234791 WEIL BLAKESLEY ENT FORCEPS 5 X 125 MM HIGH ANGLED JAWS FOR RHINOLOGY



P234790
3.5 X 125 MM

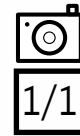

PINCE O.R.L WILDE 3 x 125 MM PR RHINOLOGIE

P234792 WILDE ENT FORCEPS 3 X 125 MM FOR RHINOLOGY



P234793
4 X 125 MM

P234794
5 X 125 MM

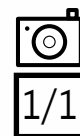

PINCE ORL - TIRE LANGUE

www.in-surg.fr

P

ENT FORCEPS - TONGUE HOLDING FORCEPS

TIRE LANGUE COLLIN 170 MM

P234795 COLLIN TONGUE HOLDING
FORCEPS 170 MM

TIRE LANGUE YOUNG 165 MM MORS CAOUTCHOUC

P234796 YOUNG TONGUE HOLDING FORCEPS 165 MM
CAOUTCHOUC JAWS

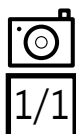

PINCE PANSEMENT

DRESSING FORCEPS

PINCE PANSEMENT BOZEMANN 275 MM
COURBE

P244797 BOZEMANN DRESSING FORCEPS 275 MM
CURVED

PINCE PANSEMENT BOZEMANN 275 MM DROITE

P244798 BOZEMANN DRESSING FORCEPS 275 MM
STRAIGHT



EN COURS DE
FABRICATION

IN'SURG
2024

PINCE PANSEMENT BOZEMANN DOUGLAS
260 MM COURBE

P244799 BOZEMANN DOUGLAS DRESSING FORCEPS
260 MM CURVED



PINCE PANSEMENT EMMET 210 MM

P244800 EMMET DRESSING FORCEPS 210 MM



PINCE PANSEMENT

DRESSING FORCEPS

PINCE PANSEMENT FOERSTER 250 MM
COURBE MORS LISSES

P244801 FOERSTER DRESSING FORCEPS
250 MM CURVED SMOOTH JAWS

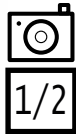

PINCE PANSEMENT FOERSTER 250 MM
DROITE MORS LISSES

P244802 FOERSTER DRESSING FORCEPS
250 MM STRAIGHT SMOOTH JAWS



LONGUEUR
LENGTH
250 MM

COURBE MORS STRIES
CURVED SERRATED JAWS

P244804

LONGUEUR
LENGTH
180 MM
250 MM

DROITE MORS STRIES
STRAIGHT SERRATED JAWS

P244803

P244805

PINCE PANSEMENT GROSS 200 MM DROITE A CREMAILLERE

P244808 GROSS DRESSING FORCEPS 200 MM STRAIGHT WITH RATCHET

PINCE PANSEMENT GROSS 200 MM DROITE SANS CREMAILLERE

P244809 GROSS DRESSING FORCEPS 200 MM STRAIGHT WITHOUT RATCHET



P244806
COURBE
CURVED

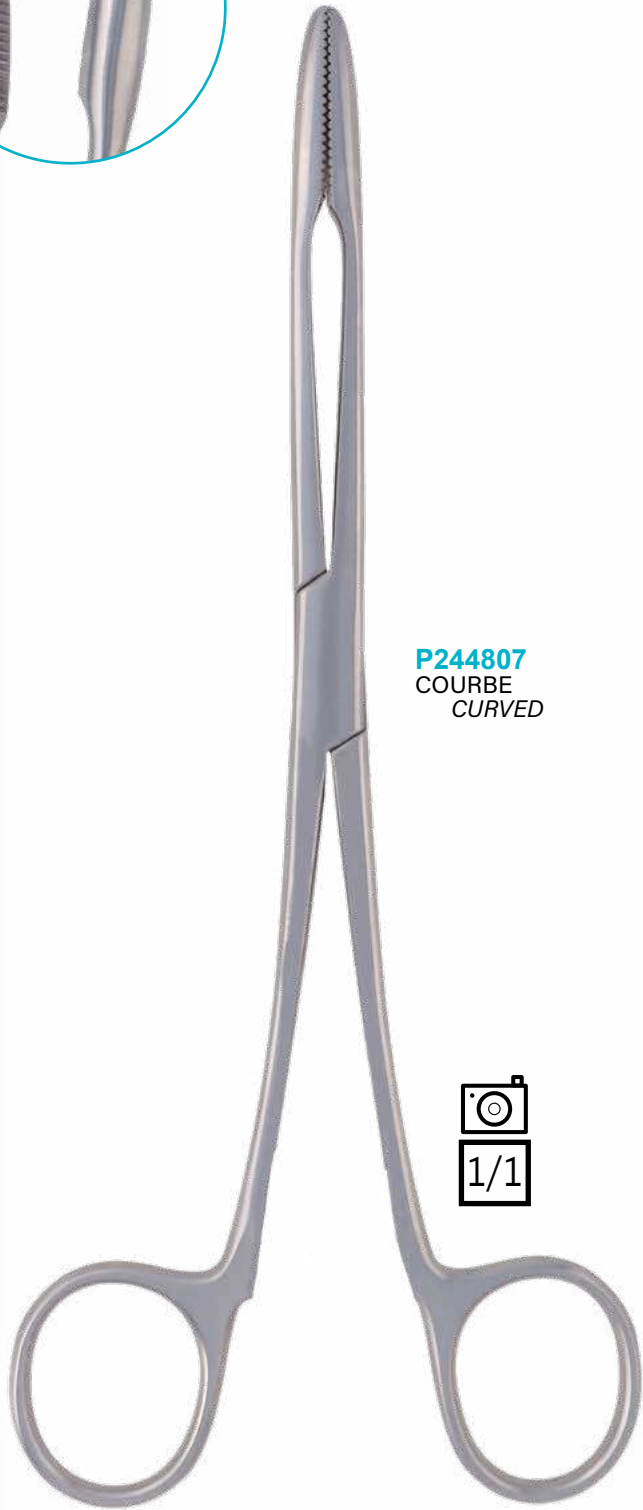
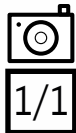

P244807
COURBE
CURVED



PINCE PANSEMENT

DRESSING FORCEPS

PINCE PANSEMENT GROSS MAIER 250 MM DROITE

P244811 GROSS MAIER DRESSING FORCEPS 250 MM STRAIGHT



P244810
COURBE
CURVED

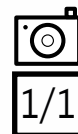

PINCE PANSEMENT KELLY 320 MM COURBE PR POLYPES
P244812 KELLY DRESSING FORCEPS 320 MM CURVED FOR POLYPS

PINCE PANSEMENT LISTER 130 MM
P244813 LISTER DRESSING FORCEPS 130 MM



P244814
150 MM

P244815
180 MM

PINCE PANSEMENT

DRESSING FORCEPS

PINCE PANSEMENT LONGUETTE 240 MM COURBE
P244816 LONGUETTE DRESSING FORCEPS 240 MM CURVED

PINCE PANSEMENT LONGUETTE 240 MM DROITE
P244818 LONGUETTE DRESSING FORCEPS 240 MM STRAIGHT

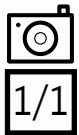

PINCE PANSEMENT LONGUETTE 240 MM COUDEE CHERON
P244817 *LONGUETTE DRESSING FORCEPS 240 MM ANGLED CELERON*



PINCE PANSEMENT

DRESSING FORCEPS

PINCE PANSEMENT USAGES 550 MM

P244821 *USAGES DRESSING FORCEPS 550 MM*

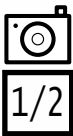

PINCE PANSEMENT PEAN 140 MM DROITE

P244822 PEAN DRESSING FORCEPS 140 MM STRAIGHT



P244823
160 MM

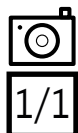

PINCE PANSEMENT PELKMANN 250 MM DROITE

P244824 PELKMANN DRESSING FORCEPS 250 MM STRAIGHT



PINCE PERFORANTE

PERFORATING FORCEPS

PINCE PERFORANTE BANKART

P254829 BANKART PERFORATING FORCEPS

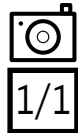

PINCE PLATRE

www.in-surg.fr

P

PLASTER CAST BREAKER FORCEPS

PINCE PLATRE 230 MM

P264830 PLASTER CAST BREAKER FORCEPS 230 MM

PINCE PLATRE HENNING 280 MM MORS 54 MM
SANS CREMAILLERE

P264831 HENNING PLASTER CAST BREAKER
FORCEPS 280 MM JAWS 54 MM WITHOUT
RATCHET

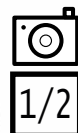
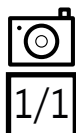
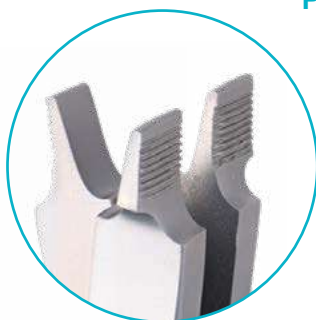

PINCE PLATRE

PLASTER CAST BREAKER FORCEPS

PINCE PLATRE WOLF 180 MM

P264832 WOLF PLASTER CAST BREAKER FORCEPS 180 MM



PINCE PLATRE WOLF 240 MM A VIS

P264833 WOLF PLASTER CAST BREAKER FORCEPS 240 MM SCREW

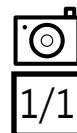

PINCE PREHENSION

GRASPING FORCEPS

PINCE PREHENSION BABCOCK 160 MM AJOUREE

P274834 *BABCOCK GRASPING FORCEPS 160 MM FENESTRATED*

PINCE PREHENSION BABCOCK 160 MM AJOUREE TUNGSTENE

P274835 *BABCOCK GRASPING FORCEPS 160 MM FENESTRATED TUNGSTEN*



P274836
200 MM

P274839
230 MM

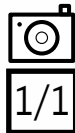

P274837
200 MM

P274840
240 MM

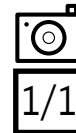

PINCE PREHENSION BABCOCK 210 MM AJOUREE ATRAUMATIQUE

P274838 *BABCOCK GRASPING FORCEPS 210 MM FENESTRATED ATRAUMATIC*



PINCE PREHENSION COLLIN 160 MM AJOUREE A VIS

P274848 *COLLIN GRASPING FORCEPS 160 MM FENESTRATED WITH SCREW*

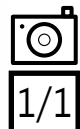

PINCE PREHENSION

GRASPING FORCEPS

PINCE PREHENSION CŒUR 250 MM AJOUREE ATRAUMATIQUE

P274847 CŒUR GRASPING FORCEPS 250 MM FENESTRATED ATRAUMATIC



PINCE PREHENSION CŒUR 160 MM AJOUREE

P274842 CŒUR GRASPING FORCEPS 160 MM FENESTRATED

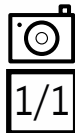

P274844
180 MM

P274845
200 MM

P274846
220 MM

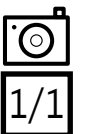

PINCE PREHENSION CHRISTOPHE 5 x 200 MM
AJOUREE ULTRA LINE

P274841 *ULTRA LINE CHRISTOPHE GRASPING
FORCEPS 5 X 200 MM FENESTRATED*

PINCE PREHENSION DUVAL 13 x 200 MM
AJOUREE DENTEE

P274852 *DUVAL GRASPING FORCEPS 13 X 200 MM
FENESTRATED TOOTHED*



P274849
13 X 140 MM

P274850
14 X 180 MM

P274859
13 X 220 MM

P274854
13 X 200 MM
TUNGSTENE
TUNGSTEN



PINCE PREHENSION DUVAL 8 x 200 MM AJOUREE STRIEE

P274851 DUVAL GRASPING FORCEPS 8 X 200 MM FENESTRATED SERRATED



P274853
200 MM

P274860
220 MM

13 MM

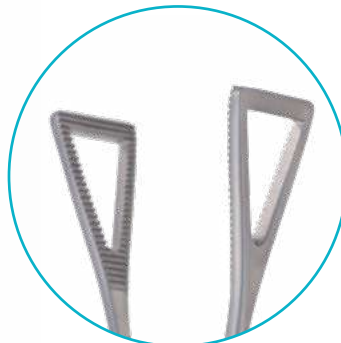

P274856
200 MM

P274861
220 MM

18 MM

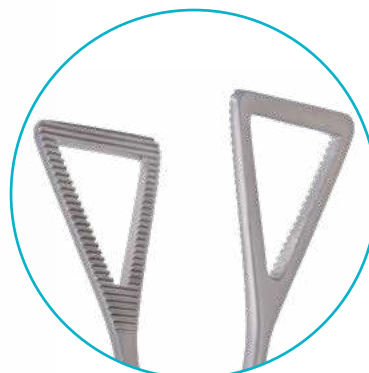

P274858
200 MM

24 MM

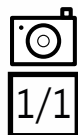

PINCE PREHENSION DUVAL 14 x 200 MM
AJOUREE ATRAUMATIQUE

P274855 *DUVAL GRASPING FORCEPS
14 X 200 MM FENESTRATED ATRAUMATIC*



P274857
20 X 200 MM



PINCE PREHENSION DUVAL HARTMANN
8 x 200 MM AJOUREE

P274862 *DUVAL HARTMANN GRASPING
FORCEPS 8 X 200 MM FENESTRATED*



P274863
12 X 200 MM



GRASPING FORCEPS

PINCE PREHENSION DUVAL WALTER 12 x 200 MM
AJOUREE

P274864 DUVAL WALTER GRASPING FORCEPS
12 X 200 MM FENESTRATED

PINCE PREHENSION GREGOIRE 160 MM
AJOUREE

P274865 GREGOIRE GRASPING FORCEPS
160 MM FENESTRATED

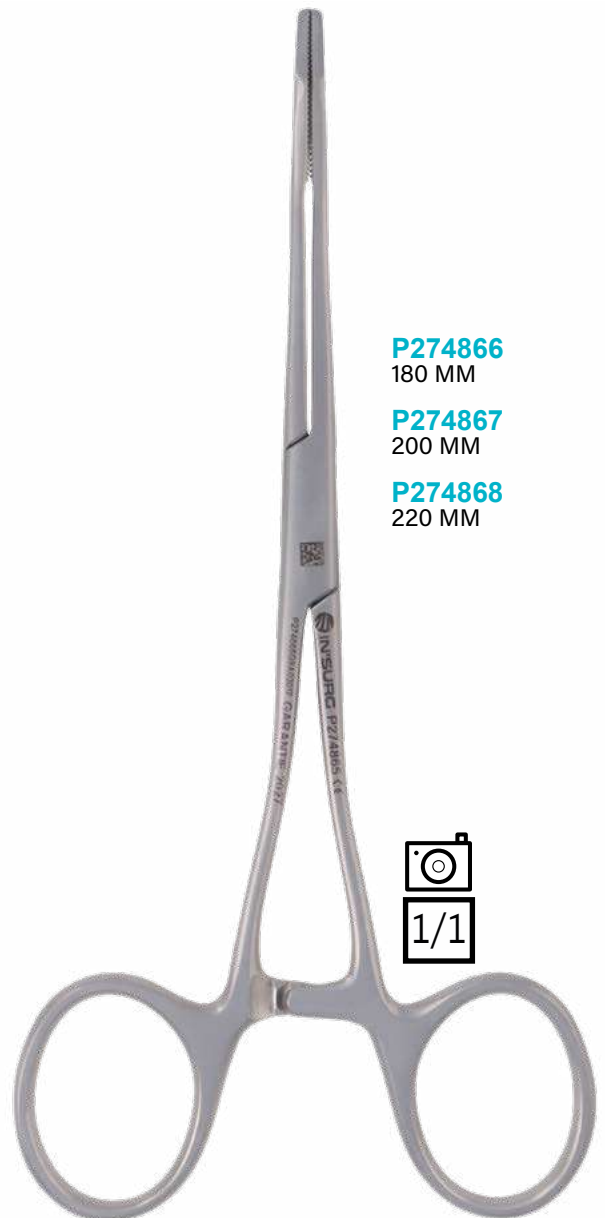

P274866
180 MM

P274867
200 MM

P274868
220 MM

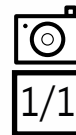

PINCE PREHENSION HALLMANN 360 MM AJOUREE
1 MORS MOBILE POUR TUNNELISATION

P274869 HALLMANN GRASPING FORCEPS 360 MM
FENESTRATED 1 MOVEABLE JAW FOR TUNNELING

PINCE PREHENSION HALLMANN 360 MM
AJOUREE 2 MORS MOBILES POUR
TUNNELISATION

P274890 HALLMANN GRASPING FORCEPS 360 MM
FENESTRATED 2 MOVEABLES JAWS FOR
TUNNELING

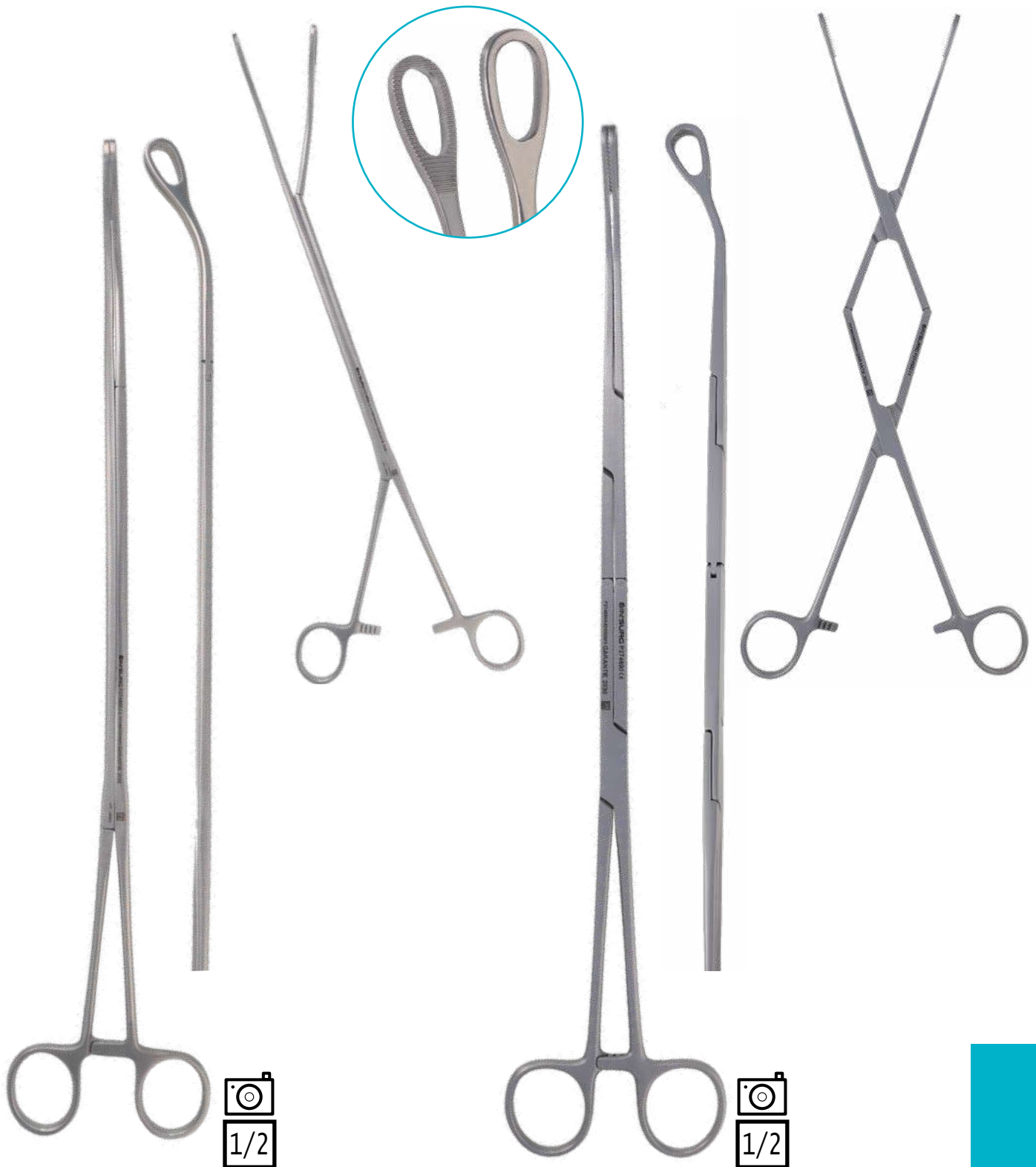

PINCE PREHENSION PENNINGTON 155 MM AJOUREE

P274872 PENNINGTON GRASPING FORCEPS 155 MM FENESTRATED

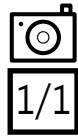

PINCE PREHENSION ALLIS 200 MM
MULTIGRIFFES TUNGSTENE

P274881 ALLIS GRASPING FORCEPS
200 MM MULTITEETHS TUNGSTEN

PINCE PREHENSION ALLIS 160 MM
MULTIGRIFFES ATRAUMATIQUE

P274878 ALLIS GRASPING FORCEPS 160 MM
MULTITEETHS ATRAUMATIC



P274877
150 MM

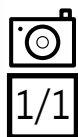

P274880
190 MM

P274884
250 MM



PINCE PREHENSION ALLIS 150 MM MULTIGRIFFES 4 X 5 GRIFFES

P274874 ALLIS GRASPING FORCEPS 150 MM MULTITEETHS 4 X 5 TEETH

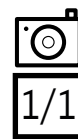

LONGUEUR LENGTH	4 X 5 GRIFFES 4 X 5 TEETH	5 X 6 GRIFFES 5 X 6 TEETH	10 X 11 GRIFFES 10 X 11 TEETH
150 MM	P274874	P274875	P274876
190 MM		P274879	
210 MM		P274882	
240 MM		P274883	

PINCE PREHENSION WILLIAMS 160 MM AJOUREE

P274873 WILLIAMS GRASPING FORCEPS 160 MM
FENESTRATED



PINCE PREHENSION OMBREDANNE 130 MM MULTIGRIFFES

P274888 OMBREDANNE GRASPING FORCEPS
130 MM MULTITEETHS



PINCE PREHENSION CHAPUT 130 MM MULTIGRIFFES

P274885 CHAPUT GRASPING FORCEPS 130 MM MULTITEETHS



P274886
160 MM



PINCE PREHENSION CHAPUT MAYO 130 MM MULTIGRIFFES A DOIGT

P274887 CHAPUT MAYO GRASPING FORCEPS 130 MM MULTITEETHS DISMOUNTABLE

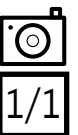
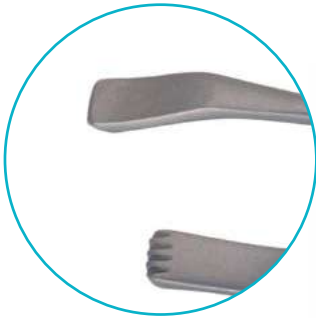

PINCE PREHENSION TUFFIER 130 MM MULTIGRIFFES

P274889 TUFFIER GRASPING FORCEPS 130 MM MULTITEETHS

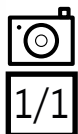

TUBING CLAMPS

PINCE PRESSE TUBE 140 MM AVEC CAVALIER

P284890 TUBING CLAMPS 140 MM WITH RIDER

PINCE PRESSE TUBE MURPHY 150 MM

P284897 MURPHY TUBING CLAMPS 150 MM



P284891
180 MM

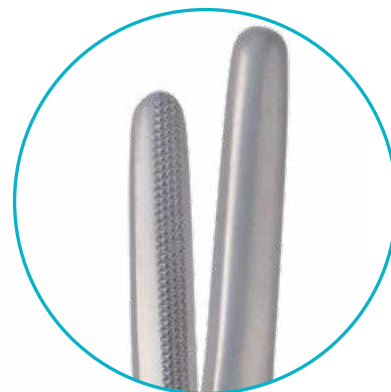
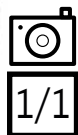

P284899
180 MM
P284900
200 MM
P284898
160 MM MORS LISSES
SMOOTH JAWS

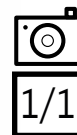

PINCE PRESSE TUBE HOFFMANN OUVERTURE MAX 17 MM
P284892 HOFFMANN TUBING CLAMPS OPENING MAX 17 MM

PINCE PRESSE TUBE WEISS 185 MM
P284901 WEISS TUBING CLAMPS 185 MM

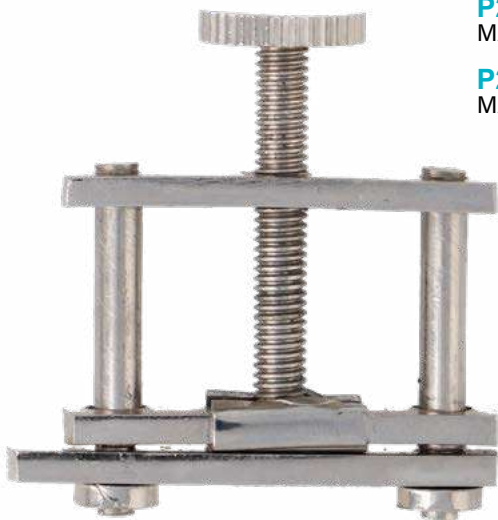

P284893
 MAX 20 MM

P284894
 MAX 25 MM



HOFFMANN OUVERTURE MAX 30 MM CHROME
P284895 HOFFMANN TUBING CLAMPS
 OPENING MAX 30 MM CHROME

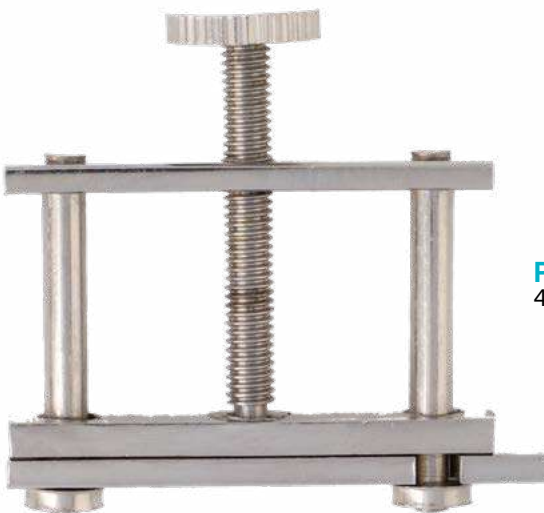

P284896
 40 MM

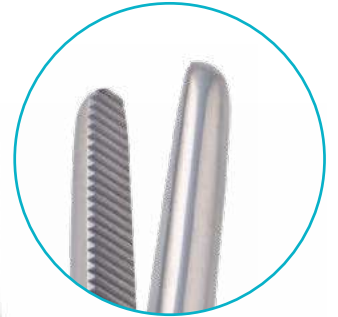
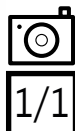

PINCE PROSTATIQUE

www.in-surg.fr

P

PROSTATIC FORCEPS

PINCE PROSTATIQUE MILLIN 230 MM PR LEVRE INFERIEURE
P294904 *MILLIN PROSTACTIC FORCEPS 230 MM FOR LOWER LIP*



PINCE PROSTATIQUE MILLIN
230 MM PR LEVRE SUPERIEUR

P294905 *MILLIN PROSTACTIC FORCEPS
230 MM FOR UPPER LIP*



PINCE PROSTATIQUE MILLIN
240 MM PORTE LIGATURE

P294906 *MILLIN PROSTACTIC FORCEPS
240 MM LIGATURE CARRIER*

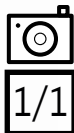

PINCE TENDONS

TENDONS FORCEPS

PINCE TENDONS A ENTRELACER 150 MM
DROITE POINTUE

P304908 TENDONS FORCEPS FOR INTERTWINE
150 MM STRAIGHT SHARP

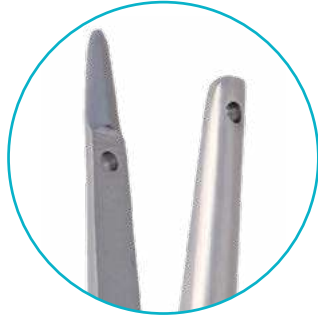

P304907
COURBE
CURVED

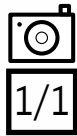

PINCE TENDONS BRAND 240 MM

P304911 BRAND TENDONS FORCEPS 240 MM

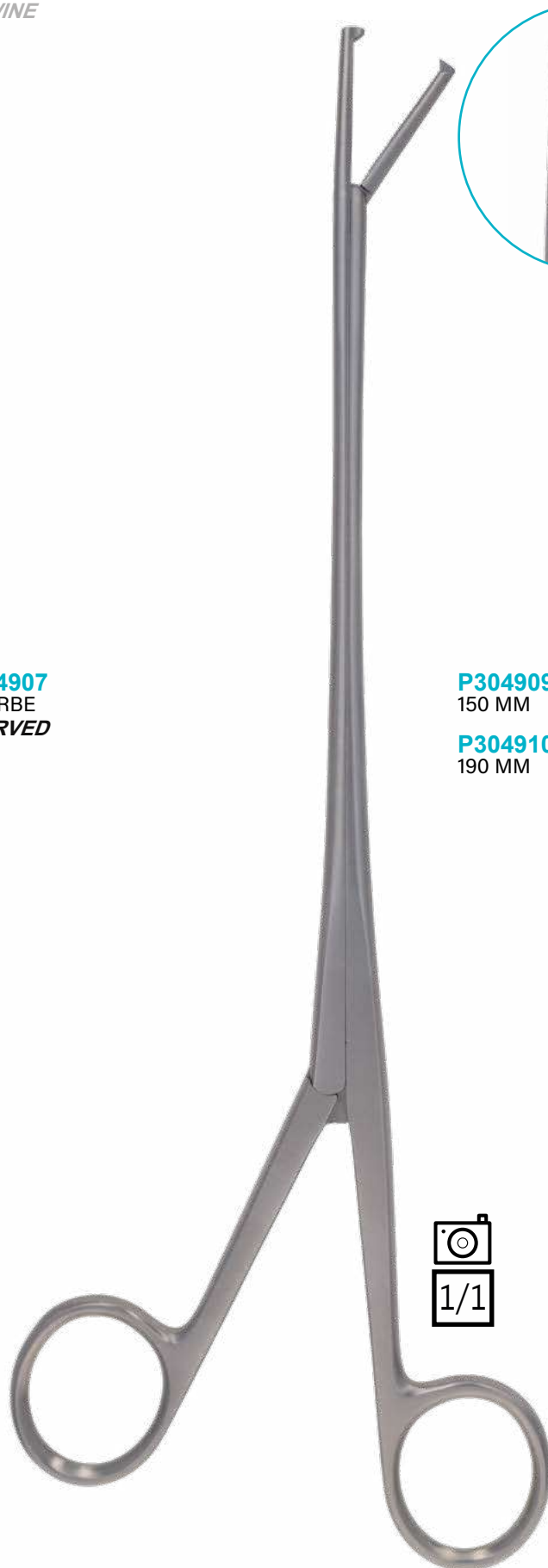

P304909
150 MM

P304910
190 MM

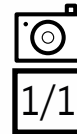

PINCE TENDONS CAROLL 110 MM
P304912 CAROLL TENDONS FORCEPS 110 MM

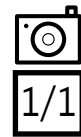

POIGNEE

HANDLE

POIGNEE 110 MM A VERROUILLAGE RAPIDE
P324914 HANDLE WITH QUICK-LOCK 110 MM

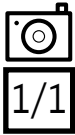

POIGNEE EN T VERROUILLAGE
P324915 HANDLE WITH QUICK-LOCK T FORM

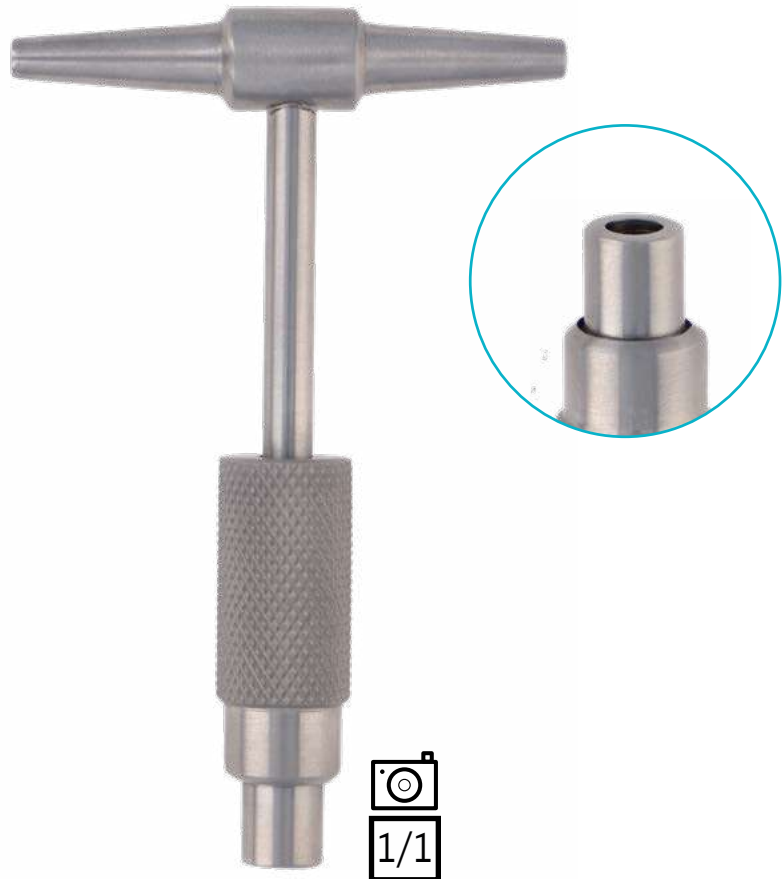

POINTE BANKART

www.in-surg.fr

P

BANKART TIP

POINTE BANKART CROCHET

P334920 BANKART TIP HOOK FORM



POINTE CARREE OMBREDANNE 4 X 185 MM
P334932 OMBREDANNE DRILL SQUARE 4 X 185 MM

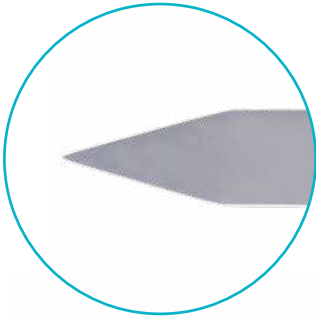

LARGEUR WIDTH	LONGUEUR LENGTH		
	165 MM	185 MM	250 MM
2 MM	P334927		
3 MM	P334928	P334930	P334936
4 MM	P334929	P334932	P334937
6 MM		P334933	P334938
8 MM		P334934	P334939
10 MM		P334935	P334940

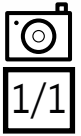

POINTE CARREE 2 X 135 MM MANCHE MOLETE
P334924 DRILL SQUARE 2 X 135 MM MOLETED HANDLE

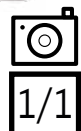

POINTE CARREE

DRILL SQUARE

POINTE CARREE PERTHES 210 MM
P334941 PERTHES DRILL SQUARE 210 MM

POINTE CARREE ROCHER 3 X 150 MM
P334942 ROCHER DRILL SQUARE 3 X 150 MM

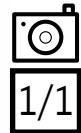
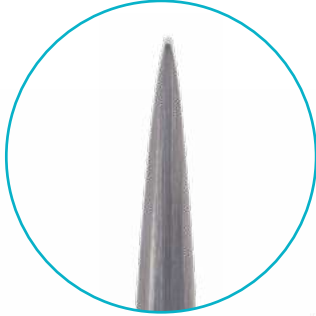

	LONGUEUR LENGTH	
DIAMETRE DIAMETER	150 MM	180 MM
3 MM	P334942	P334943

POINTE CARREE 3 X 200 MM TIGE RONDE
P334944 DRILL SQUARE 3 X 200 MM ROUND ROD

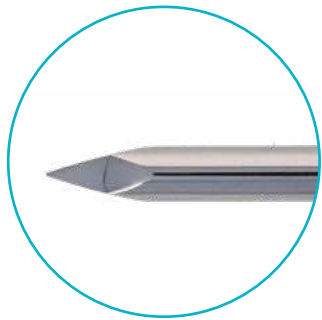

DIAMETRE DIAMETER	LONGUEUR LENGTH				
	200 MM	215 MM	220 MM	250 MM	300 MM
2 MM	P334946				
2,5 MM				P334951	
3 MM	P334944		P334950		P334952
4 MM	P334945	P334949			P334953
5 MM					P334954
6 MM	P334947				
7 MM	P334948				

POINTE CARREE TRILLAT 3 X 185 MM
P334959 TRILLAT DRILL SQUARE 3 X 185 MM

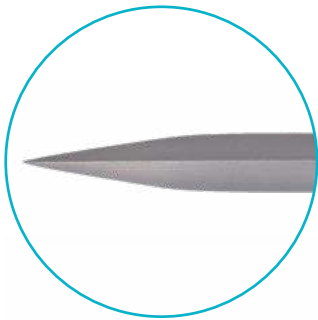

LARGUEUR WIDTH	LONGUEUR LENGTH		
	165 MM	185 MM	250 MM
3 MM	P334955	P334959	P334963
4 MM	P334956	P334960	P334964
5 MM	P334957	P334961	P334965
6 MM	P334958	P334962	P334966



TOUS NOS PRODUITS ULTRA LINE SONT GARANTIS 10 ANS
ET REMPLACÉS SANS CONDITIONS

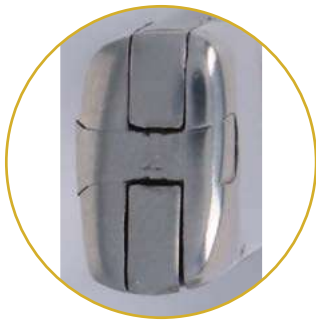

AXE TRAVERSANT
NON MONOBLOC



BOITIER MONOBLOC

SPÉCIFICITÉS :

Amélioration de la fiabilité et la durée de vie de l'instrument grâce au boîtier **MONOBLOC**

Les plaquettes sont fraisées et usinées en pyramide, elles sont fixées en même temps que la réalisation du traitement thermique du porte aiguille.

Meilleure tenue de l'aiguille en bout de plaquette

Parfait ajustage des plaquettes en **carbure de tungstène**



PORTE AIGUILLE

www.in-surg.fr

P

NEEDLE HOLDER

PORTE AIGUILLE BOZEMANN 260 MM TUNGSTENE
P344971 BOZEMANN NEEDLE HOLDER 260 MM TUNGSTEN



PORTE AIGUILLE

NEEDLE HOLDER

PORTE AIGUILLE BAUMGARTNER 140 MM TUNGSTENE
P344969 BAUMGARTNER NEEDLE HOLDER 140 MM TUNGSTEN

PORTE AIGUILLE BAUMGARTNER 130 MM
PR SUTURE 2/0 A 4/0 ULTRA LINE

P344968 ULTRA LINE BAUMGARTNER NEEDLE
HOLDER 130 MM FOR SUTURE 2/0 A 4/0

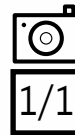
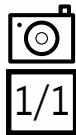

 **IN'SURG**
ULTRA LINE

**Garantie
totale
10 ANS**
sans conditions

PORTE AIGUILLE CONVERSE 130 MM TUNGSTENE

P344989 CONVERSE NEEDLE HOLDER 130 MM TUNGSTEN

PORTE AIGUILLE NIEVERT 130 MM TUNGSTENE

P345090 NIEVERT NEEDLE HOLDER 130 MM TUNGSTEN



PORTE AIGUILLE BROWN 130 MM

P344972 BROWN NEEDLE HOLDER 130 MM



PORTE AIGUILLE

NEEDLE HOLDER

PORTE AIGUILLE CRILE WOOD 150 MM

P344996 CRILE WOOD NEEDLE HOLDER 150 MM

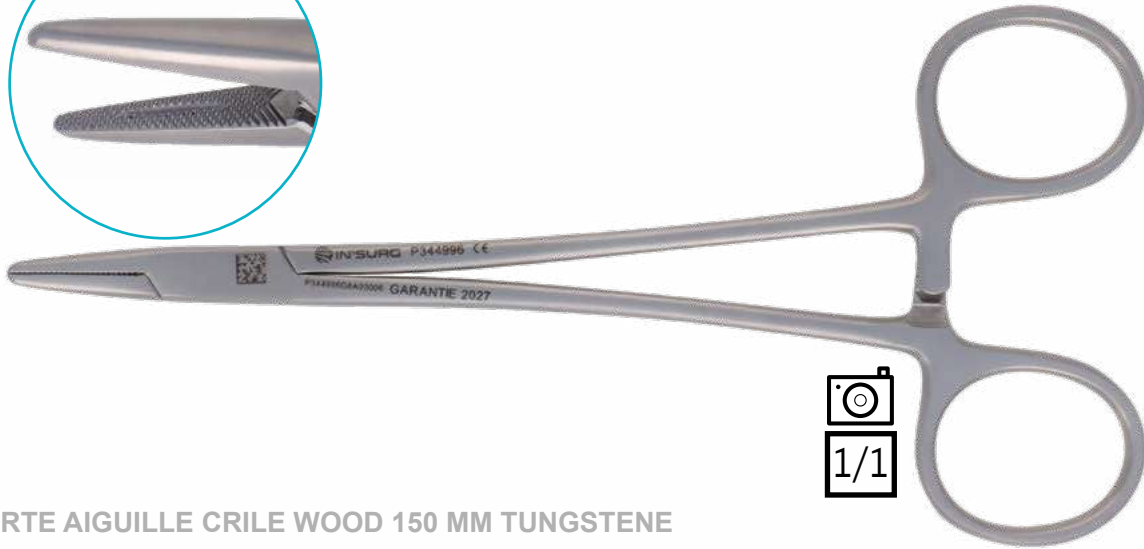

P344999
180 MM

P345001
200 MM

P345003
230 MM

PORTE AIGUILLE CRILE WOOD 150 MM TUNGSTENE

P344997 CRILE WOOD NEEDLE HOLDER 150 MM TUNGSTEN

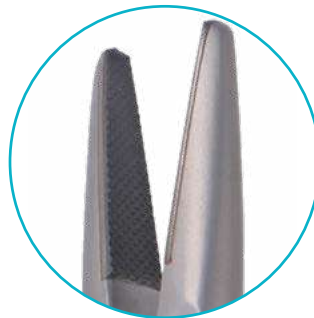

LONGUEUR
LENGTH

- 150 MM
- 180 MM
- 200 MM
- 230 MM
- 260 MM
- 300 MM

MORS LISSES
SMOOTH JAWS

- P344997
- P345000
- P345002
- P345004
- P345005
- P345006

P344998

PORTE AIGUILLE CRILE WOOD 180 MM PR SUTURE 4/0 A 6/0 ULTRA LINE

P344991 ULTRA LINE CRILE WOOD NEEDLE HOLDER 180 MM FOR SUTURE 4/0 A 6/0



LONGUEUR
LENGTH

150 MM

P344990

180 MM

P344991

200 MM

P344992

230 MM

P344993

260 MM

P344994

300 MM

P344995



PORTE AIGUILLE

NEEDLE HOLDER

PORTE AIGUILLE DERF 120 MM TUNGSTENE

P345018 DERF NEEDLE HOLDER 120 MM TUNGSTEN

PORTE AIGUILLE DOYEN 130 MM

P345019 DOYEN NEEDLE HOLDER 130 MM

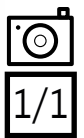
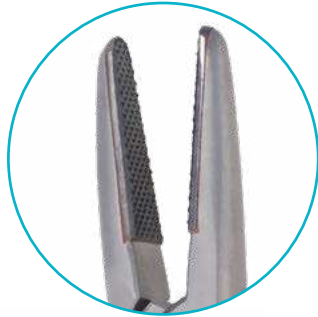

PORTE AIGUILLE DEBAKEY 180 MM TUNGSTENE
P345013 DEBAKEY NEEDLE HOLDER 180 MM TUNGSTEN



PORTE AIGUILLE DEBAKEY 150 MM PR SUTURE
 4/0 A 6/0 ULTRA LINE

P345007 ULTRA LINE DEBAKEY NEEDLE HOLDER
 150 MM FOR SUTURE 4/0 A 6/0

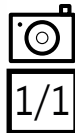

LONGUEUR

LENGTH	
180 MM	P345013
200 MM	P345014
230 MM	P345015
260 MM	P345016
300 MM	P345017

LONGUEUR

LENGTH	
150 MM	P345007
180 MM	P345008
200 MM	P345009
230 MM	P345010
260 MM	P345011
300 MM	P345012

PORTE AIGUILLE

NEEDLE HOLDER

PORTE AIGUILLE EUPHRATE PASQUE 150 MM TUNGSTENE
P345020 EUPHRATE PASQUE NEEDLE HOLDER 150 MM TUNGSTEN



LONGUEUR

LENGTH

150 MM

180 MM

200 MM

230 MM

P345020

P345022

P345023

P345024

MORS LISSES
 SMOOTH JAWS

P345021

PORTE AIGUILLE FINOCHIETTO 270 MM COUDE TUNGSTENE
P345025 FINOCHIETTO NEEDLE HOLDER 270 MM ANGLED TUNGSTEN

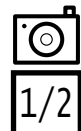

PORTE AIGUILLE FINOCHIETTO DELICAT
130 MM

P345026 *FINOCHIETTO NEEDLE HOLDER DELICAT
130 MM*

PORTE AIGUILLE FINOCHIETTO DERF
120 MM PR SUTURE 4/0 A 6/0 ULTRA LINE

P345029 *ULTRA LINE FINOCHIETTO DERF NEEDLE
HOLDER 120 MM FOR SUTURE 4/0 A 6/0*

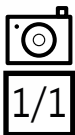

LONGUEUR
LENGTH

130 MM

P345026

150 MM

P345027

180 MM

P345028

PORTE AIGUILLE

NEEDLE HOLDER

PORTE AIGUILLE / CISEAU GILLIES 160 MM
TUNGSTENE

P345030 GILLIES NEEDLE HOLDER / SCISSOR 160 MM
TUNGSTEN

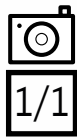
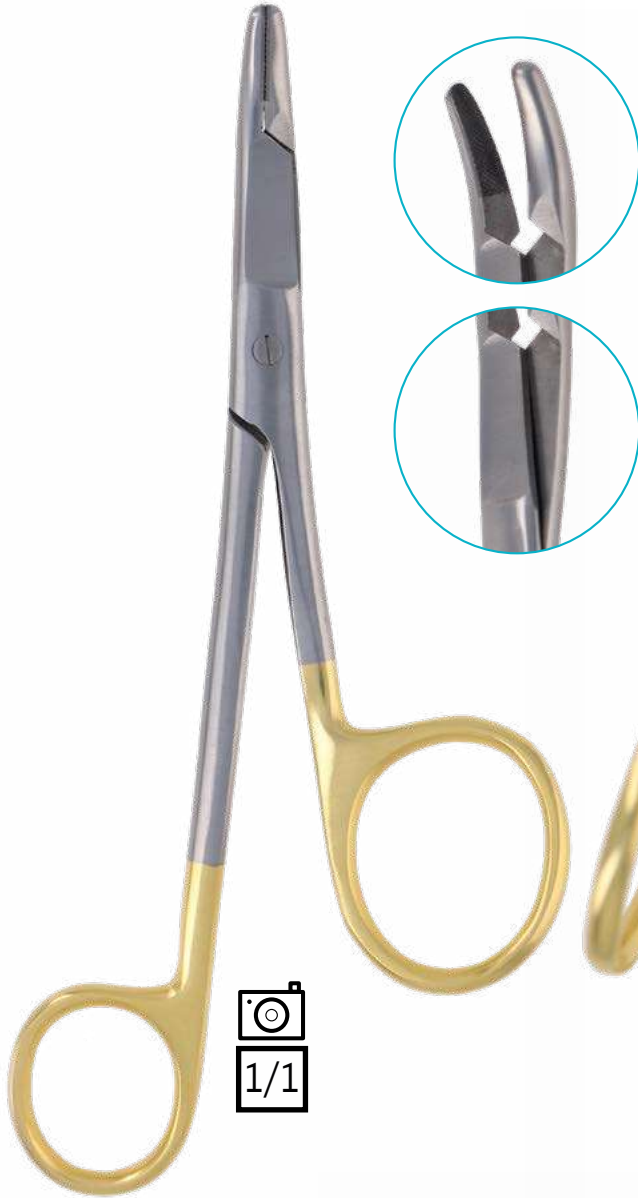

PORTE AIGUILLE / CISEAU GILLIES 145 MM MINI

P345031 GILLIES NEEDLE HOLDER / SCISSOR
145 MM MINI

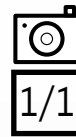
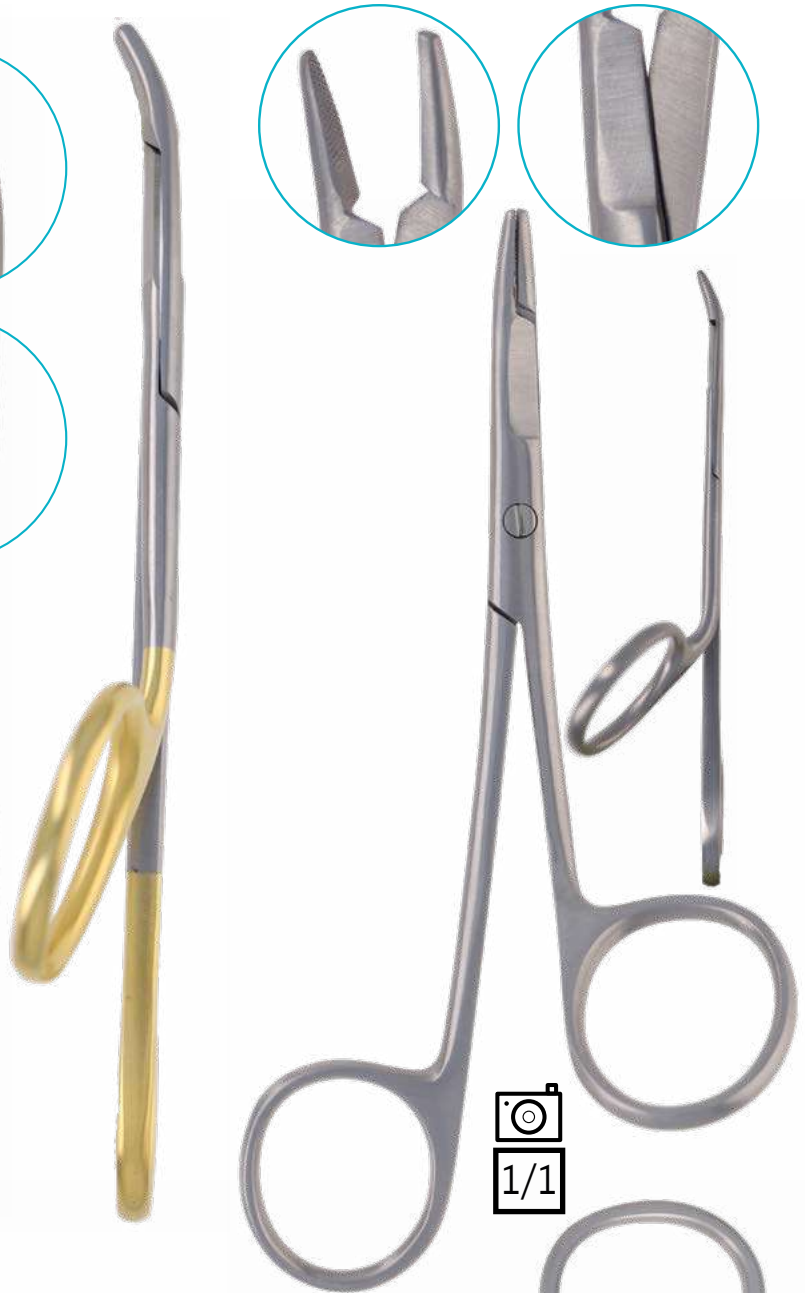

PORTE AIGUILLE HALSEY 130 MM

P345032 HALSEY NEEDLE HOLDER 130 MM

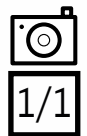

PORTE AIGUILLE HALSEY 130 MM TUNGSTENE
P345033 HALSEY NEEDLE HOLDER 130 MM TUNGSTEN



LONGUEUR
LENGTH

130 MM

P345033

MORS LISSES
SMOOTH JAWS

P345034

PORTE AIGUILLE HALSEY 130 MM PR SUTURE 6/0 A 8/0 ULTRA LINE
P345035 ULTRA LINE HALSEY NEEDLE HOLDER 130 MM FOR SUTURE 6/0 A 8/0

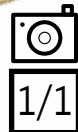

LONGUEUR
LENGTH

130 MM

P345035

MORS LISSES
SMOOTH JAWS

P345036

PORTE AIGUILLE

NEEDLE HOLDER

PORTE AIGUILLE HEANEY 210 MM COURBE
TUNGSTENE

P345037 HEANEY NEEDLE HOLDER 210 MM
CURVED TUNGSTEN

PORTE AIGUILLE JAMISON 235 MM

P345038 JAMISON NEEDLE HOLDER 235 MM



PORTE AIGUILLE MASSON 270 MM TUNGSTENE
P345039 MASSON NEEDLE HOLDER 270 MM TUNGSTEN

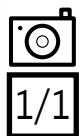

PORTE AIGUILLE

NEEDLE HOLDER

PORTE AIGUILLE MATHIEU STANDARD
140 MM

P345055 MATHIEU NEEDLE HOLDER
STANDARD 140 MM



P345046
170 MM

PORTE AIGUILLE MATHIEU STANDARD
140 MM TUNGSTENE

P345056 MATHIEU NEEDLE HOLDER STANDARD
140 MM TUNGSTEN



P345057
170 MM

P345058
200 MM

PORTE AIGUILLE MATHIEU DELICAT 170 MM TUNGSTENE
P345044 *MATHIEU NEEDLE HOLDER DELICAT 170 MM TUNGSTEN*

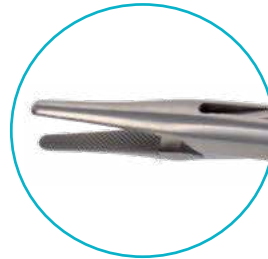

P345043
140 MM

P345045
200 MM

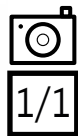

PORTE AIGUILLE

NEEDLE HOLDER

PORTE AIGUILLE MATHIEU STANDARD ROBUSTE 200 MM TUNGSTENE

P345061 MATHIEU NEEDLE HOLDER STANDARD ROBUST 200 MM TUNGSTEN

PORTE AIGUILLE MATHIEU 140 MM PR SUTURE 1/0 A 4/0 ULTRA LINE
P345040 ULTRA LINE MATHIEU NEEDLE HOLDER 140 MM FOR SUTURE 1/0 A 4/0



P345041
170 MM

P345042
200 MM

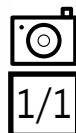

PORTE AIGUILLE

NEEDLE HOLDER

PORTE AIGUILLE MAYO HEGAR 140 MM
P345070 MAYO HEGAR NEEDLE HOLDER 140 MM

PORTE AIGUILLE MAYO HEGAR 140 MM
 TUNGSTENE
P345071 MAYO HEGAR NEEDLE HOLDER 140 MM
 TUNGSTEN



LONGUEUR

LENGTH

140 MM	P345070
160 MM	P345072
180 MM	P345074
200 MM	P345076
240 MM	P345078
260 MM	P345080
300 MM	P345082

LONGUEUR

LENGTH

140 MM	P345071
160 MM	P345073
180 MM	P345075
200 MM	P345077
240 MM	P345079
260 MM	P345081
300 MM	P345083

PORTE AIGUILLE MAYO HEGAR 230 MM FORT PR SUTURE 1/0 A 4/0 ULTRA LINE

P345084 ULTRA LINE MAYO HEGAR NEEDLE HOLDER 230 MM STRONG FOR SUTURE 1/0 A 4/0

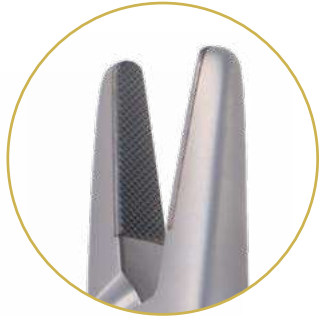

PORTE AIGUILLE MAYO HEGAR 140 MM PR SUTURE 1/0 A 4/0 ULTRA LINE

P345063 ULTRA LINE MAYO HEGAR NEEDLE HOLDER 140 MM FOR SUTURE 1/0 A 4/0

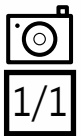

- P345065**
160 MM 1/0 A 4/0
- P345066**
180 MM 1/0 A 4/0
- P345067**
200 MM 1/0 A 4/0
- P345068**
240 MM 1/0 A 4/0
- P345064**
260 MM 1/0 A 4/0
- P345069**
300 MM 1/0 A 4/0

PORTE AIGUILLE

NEEDLE HOLDER

PORTE AIGUILLE MAYO HEGAR 160 MM COURBE
P345134 MAYO HEGAR NEEDLE HOLDER 160 MM CURVED

PORTE AIGUILLE MAYO HEGAR
 200 MM TUNGSTENE COURBE
P345137 MAYO HEGAR NEEDLE HOLDER
 200 MM TUNGSTEN CURVED



P345135
180 MM

P345136
200 MM



P345138
240 MM

P345139
260 MM

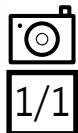

PORTE AIGUILLE MAYO HEGAR 270 MM COUDE
P345062 MAYO HEGAR NEEDLE HOLDER 270 MM ANGLED

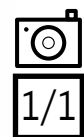

PORTE AIGUILLE / CISEAU OLSEN HEGAR 180 MM

P345096 OLSEN HEGAR NEEDLE HOLDER / SCISSOR 180 MM

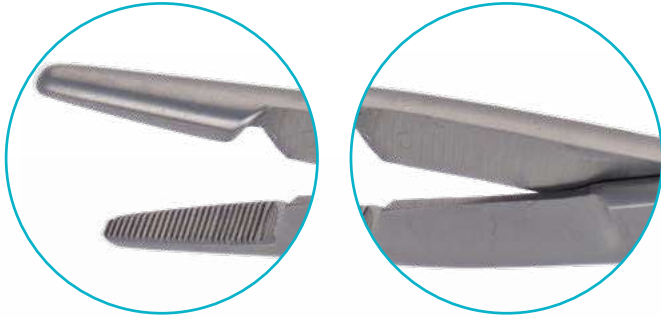

LONGUEUR

LENGTH

140 MM

P345093

180 MM

P345096

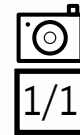

PORTE AIGUILLE / CISEAU OLSEN HEGAR 170 MM TUNGSTENE

P345095 OLSEN HEGAR NEEDLE HOLDER / SCISSOR 170 MM TUNGSTEN

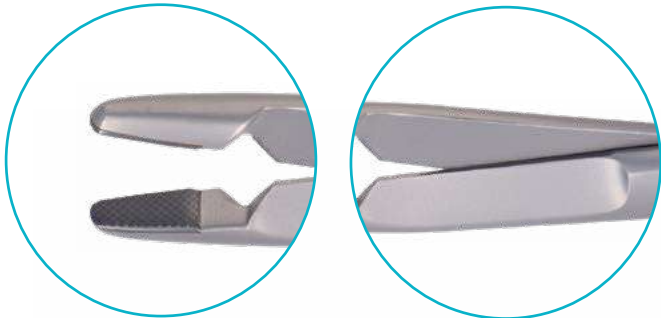

LONGUEUR

LENGTH

120 MM

P345092

140 MM

P345094

170 MM

P345095

190 MM

P345097

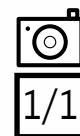

PORTE AIGUILLE / CISEAU OLSEN 140 MM PR SUTURE 4/0 A 6/0 ULTRA LINE

P345091 ULTRA LINE OLSEN NEEDLE HOLDER / SCISSOR 140 MM FOR SUTURE 4/0 A 6/0



IN'SURG
ULTRA LINE

Garantie
totale
10 ANS
sans conditions

PORTE AIGUILLE OLSEN MINI 120 MM PR SUTURE 5/0 A 7/0 ULTRA LINE

P345099 ULTRA LINE OLSEN MINI NEEDLE HOLDER / SCISSOR 120 MM FOR SUTURE 5/0 A 7/0

Garantie
totale
10 ANS
sans conditions



P345100
180 MM 5/0 A 7/0

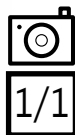

PORTE AIGUILLE MERVEILLEUX 150 MM
PR SUTURE 6/0 A 8/0 ULTRA LINE

P345085 *ULTRA LINE MICROVASCULAR NEEDLE
HOLDER 150 MM FOR SUTURE 6/0 A 8/0*



PORTE AIGUILLE MICROVASCULAIRE 150 MM
PR SUTURE 5/0 A 7/0 ULTRA LINE

P345086 *ULTRA LINE MICROVASCULAR NEEDLE
HOLDER 150 MM FOR SUTURE 5/0 A 7/0*

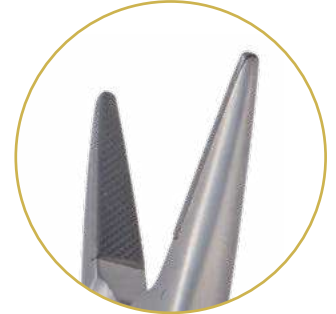

**Garantie
totale
10 ANS
sans conditions**

P345087
180 MM 5/0 A 7/0

P345088
200 MM 5/0 A 7/0

P345089
230 MM 5/0 A 7/0

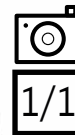
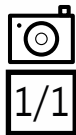

PORTE AIGUILLE

NEEDLE HOLDER

PORTE AIGUILLE RYDER MINI 130 MM TUNGSTENE
P345112 RYDER MINI NEEDLE HOLDER 130 MM TUNGSTEN



LONGUEUR
 LENGTH

RYDER MINI

RYDER STANDARD

130 MM	P345112	P345118
150 MM	P345113	P345119
180 MM	P345114	P345120
200 MM	P345115	P345121
230 MM	P345116	P345122
260 MM	P345117	P345123

PORTE AIGUILLE RYDER 130 MM PR SUTURE 4/0 A 6/0 ULTRA LINE
P345102 ULTRA LINE RYDER NEEDLE HOLDER 130 MM FOR SUTURE 4/0 A 6/0

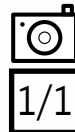

LONGUEUR
 LENGTH

RYDER MICRO
 PR SUTURE 6/0 A 8/0
 FOR SUTURE 6/0 A 8/0

RYDER STANDARD
 PR SUTURE 4/0 A 6/0
 FOR SUTURE 4/0 A 6/0

130 MM	P345107	P345102
150 MM	P345108	P345106
180 MM	P345109	P345103
200 MM	P345110	P345104
230 MM	P345111	P345105

IN'SURG
 ULTRA LINE



PORTE AIGUILLE SAROT 180 MM TUNGSTENE
P345124 SAROT NEEDLE HOLDER 180 MM TUNGSTEN

PORTE AIGUILLE WEBSTER 130 MM
MORS LISSES TUNGSTENE
P345129 WEBSTER NEEDLE HOLDER 130 MM
SMOOTH JAWS TUNGSTEN

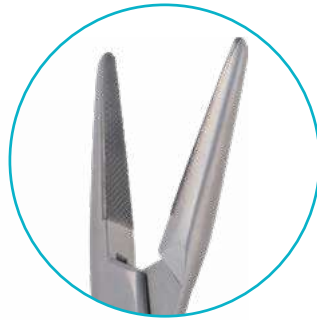

P345125
200 MM

P345126
270 MM

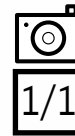
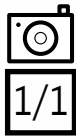

PORTE AIGUILLE

NEEDLE HOLDER

PORTE AIGUILLE STRATTE 230 MM
P345127 STRATTE NEEDLE HOLDER 230 MM

PORTE AIGUILLE STRATTE 230 MM TUNGSTENE
P345128 STRATTE NEEDLE HOLDER 230 MM TUNGSTEN

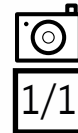
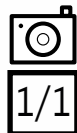

PORTE AIGUILLE YOUNG MILLIN 250 MM AVEC AIGUILLE N°1 PR PROSTATECTOMIE
P345130 *YOUNG MILLIN NEEDLE HOLDER 250 MM WITH NEEDLE N°1 FOR PROSTATECTOMY*

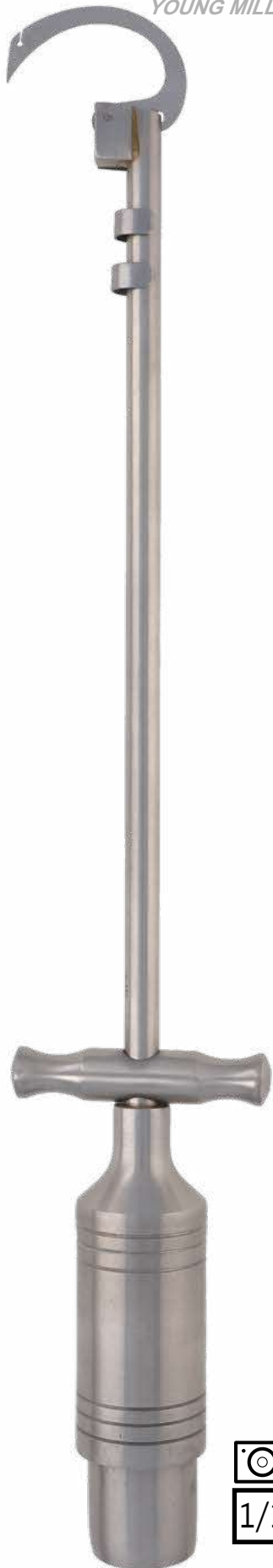

N°1 **P345131**

N°2 **P345132**

N°3 **P345133**

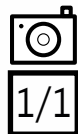

PORTE AIGUILLE CASTROJIEVO 0,8 x 1,2 x 12 x 140 MM DROIT CORPS ROND A VERROU MORS LISSES
P344975 CASTROJIEVO NEEDLE HOLDER 0,8 X 1,2 X 12 X 140 MM STRAIGHT ROUND BODY WITH LOCK SMOOTH JAWS

CORPS ROND
ROUND BODY

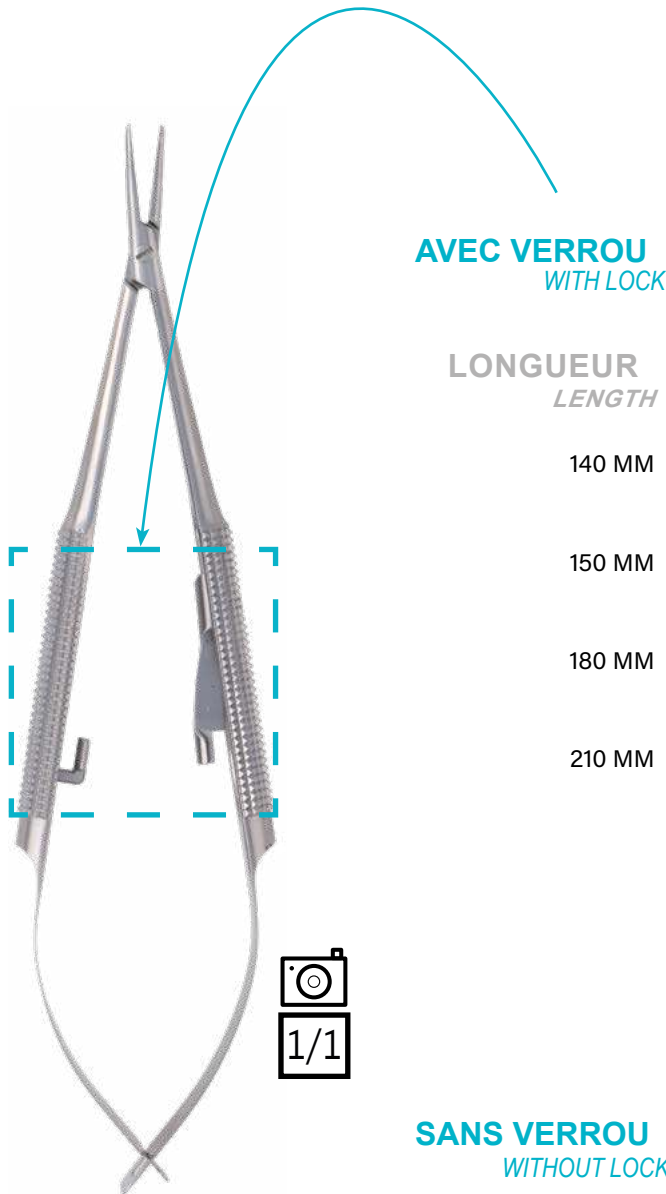

AVEC VERROU
 WITH LOCK

0,8 X 1,2 X 12 MM

1,2 X 1,6 X 12 MM

LONGUEUR
 LENGTH

140 MM

P344975

150 MM

P344979

180 MM

P344983

210 MM

P344987

SANS VERROU
 WITHOUT LOCK

0,8 X 1,2 X 12 MM

1,2 X 1,6 X 12 MM

LONGUEUR
 LENGTH

140 MM

P344976

150 MM

P344980

180 MM

P344984

210 MM

P344988

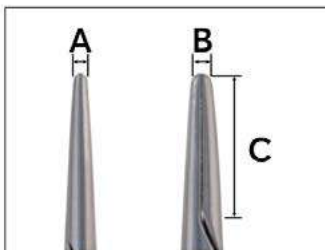

A = EPaisseur B = LARGEUR C = LONGUEUR

EXEMPLE : 1,3 X 2 X 12 MM

A B C

PORTE AIGUILLE CASTROJIEVO 0,8 x 1,2 x 12 x 140 MM COURBE CORPS ROND A VERROU MORS LISSES
P344973 CASTROJIEVO NEEDLE HOLDER 0,8 X 1,2 X 12 X 140 MM CURVED ROUND BODY WITH LOCK SMOOTH JAWS

CORPS ROND ROUND BODY

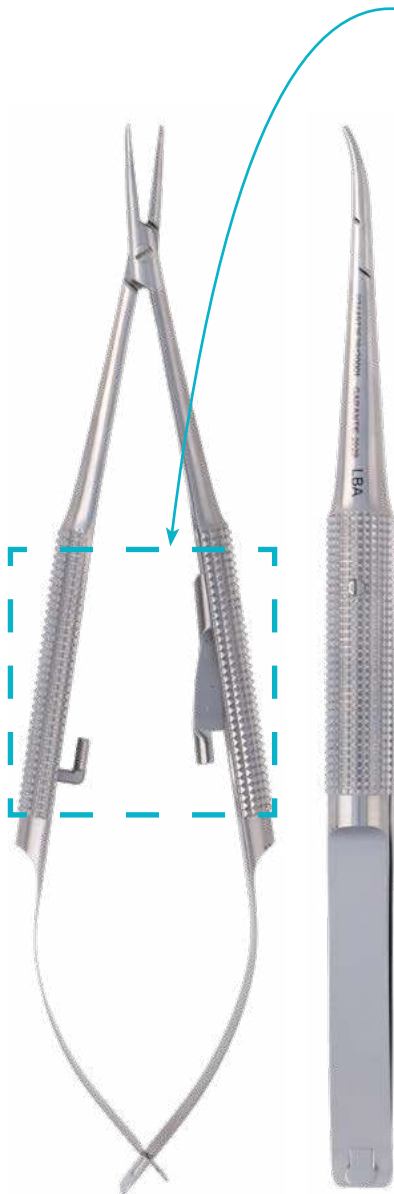

AVEC VERROU
WITH LOCK

0,8 X 1,2 X 12 MM

1,2 X 1,6 X 12 MM

LONGUEUR
LENGTH

140 MM

P344973

150 MM

P344977

180 MM

P344981

210 MM

P344985



SANS VERROU
WITHOUT LOCK

0,8 X 1,2 X 12 MM

1,2 X 1,6 X 12 MM

LONGUEUR
LENGTH

140 MM

P344974

150 MM

P344978

180 MM

P344982

210 MM

P344986

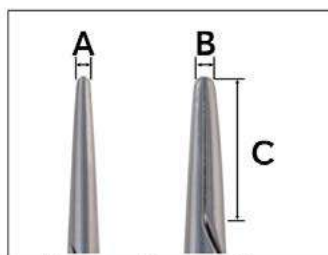

A = EPAISSEUR B = LARGEUR C = LONGUEUR

EXEMPLE : 1,3 X 2 X 12 MM

A B C

PORTE AIGUILLE MICRO CASTROJIEVO 1,6 x 2,3 x 12 x 140 MM DROIT CORPS PLAT MORS STRIES TUNGSTENE AVEC VERROU

P355140 MICRO CASTROJIEVO NEEDLE HOLDER 1,6 X 2,3 X 12 X 140 MM STRAIGHT FLAT BODY SERRATED JAWS TUNGSTEN WITH LOCK

CORPS PLAT
FLAT BODY

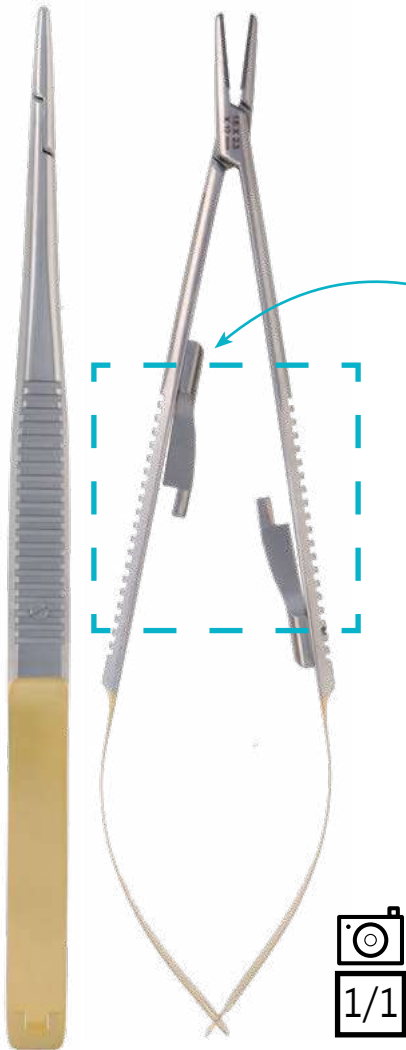

MORS STRIES
SERRATED JAWS

1,6 X 2,3 X 12 X 140 MM

DROIT
STRAIGHT

COURBE
CURVED

AVEC VERROU
WITH LOCK

P355140

P355136

SANS VERROU
WITHOUT LOCK

P355138

P355134

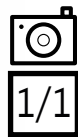

MORS LISSES
SMOOTH JAWS

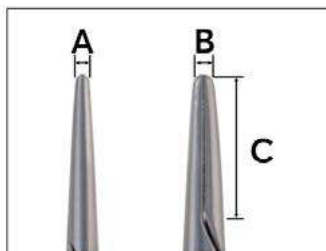

A = EPAISSEUR B = LARGEUR C = LONGUEUR
EXEMPLE : 1,3 X 2 X 12 MM

A B C

1,6 X 2,3 X 12 X 140 MM

DROIT
STRAIGHT

COURBE
CURVED

AVEC VERROU
WITH LOCK

P355141

P355137

SANS VERROU
WITHOUT LOCK

P355139

P355135

PORTE AIGUILLE MICRO CASTROJIEVO 0,75 x 1 x 12 x 140 MM COURBE CORPS PLAT A VERROU
MORS LISSES

P355144 MICRO CASTROJIEVO NEEDLE HOLDER 0,75 X 1 X 12 X 140 MM CURVED FLAT BODY WITH LOCK
SMOOTH JAWS

CORPS PLAT
FLAT BODY

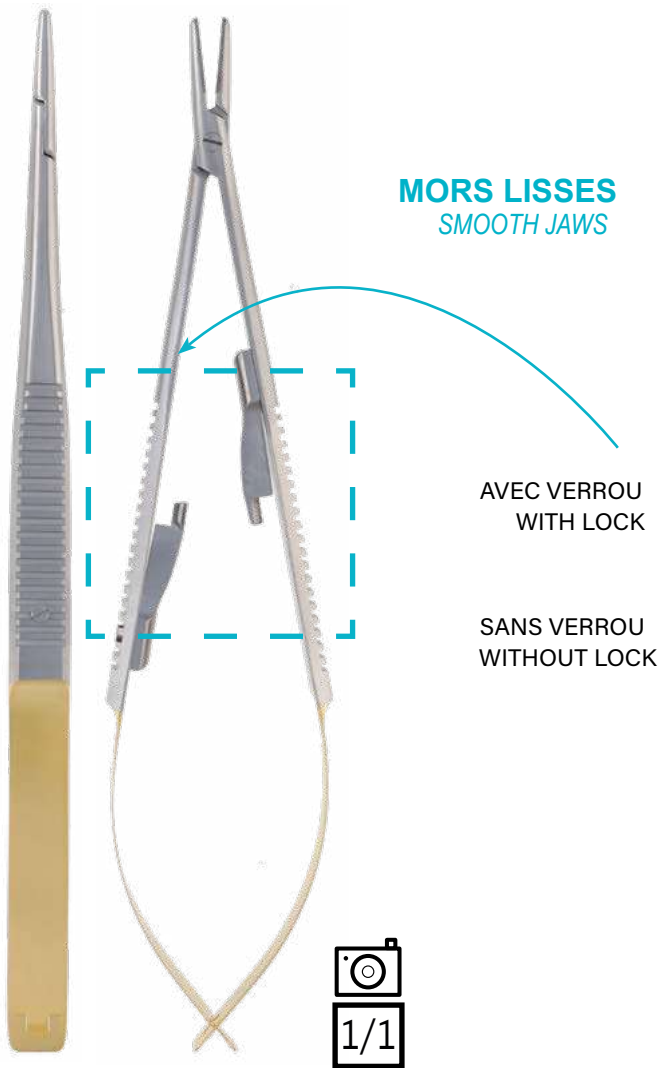

0,75 X 1 X 12 X 140 MM

DROIT
STRAIGHT

COURBE
CURVED

P355147

P355144

P355146

P355142

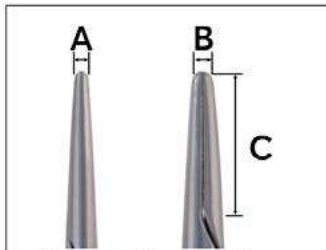

A = EPAISSEUR B = LARGEUR C = LONGUEUR

EXEMPLE : 1,3 X 2 X 12 MM

A B C

PORTE AIGUILLE MICRO CASTROJIEVO 1,3 x 2 x 12 x 140 MM COURBE CORPS ROND MORS LISSES TUNGSTENE SANS VERROU

P355149 MICRO CASTROJIEVO NEEDLE HOLDER 1,3 X 2 X 12 X 140 MM CURVED ROUND BODY SMOOTH JAWS TUNGSTEN WITHOUT LOCK

CORPS ROND
ROUND BODY



MORS DIAMANTES
DIAMOND JAWS

AVEC VERROU
WITH LOCK

1,3 X 2 X 12 X 180 MM

DROIT
STRAIGHT

P355161

MORS LISSES
SMOOTH JAWS

AVEC VERROU
WITH LOCK

1,3 X 2 X 12 X 140 MM

DROIT
STRAIGHT

COURBE
CURVED

P355150

P355151

P355149

SANS VERROU
WITHOUT LOCK



MORS STRIES
SERRATED JAWS

1,3 X 2 X 12 X 150 MM

DROIT
STRAIGHT

COURBE
CURVED

AVEC VERROU
WITH LOCK

P355156

P355154

SANS VERROU
WITHOUT LOCK

P355155

P355153

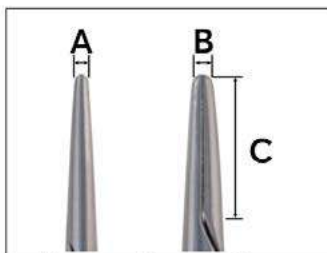

A = EPAISSEUR B = LARGEUR C = LONGUEUR
EXEMPLE : 1,3 X 2 X 12 MM
A B C

PORTE AIGUILLE MICRO CASTROJIEVO 180 MM DROIT CORPS ROND MORS DIAMANTES A
VERROU DELICAT

P355157 MICRO CASTROJIEVO NEEDLE HOLDER 180 MM STRAIGHT ROUND BODY DIAMOND JAWS
WITH LOCK DELICAT

MORS DIAMANTES
DIAMOND JAWS

CORPS ROND
ROUND BODY

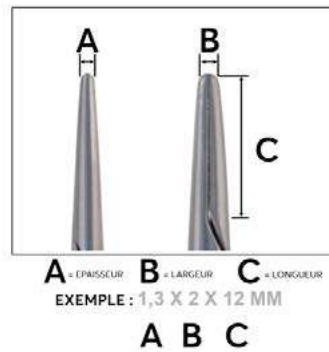
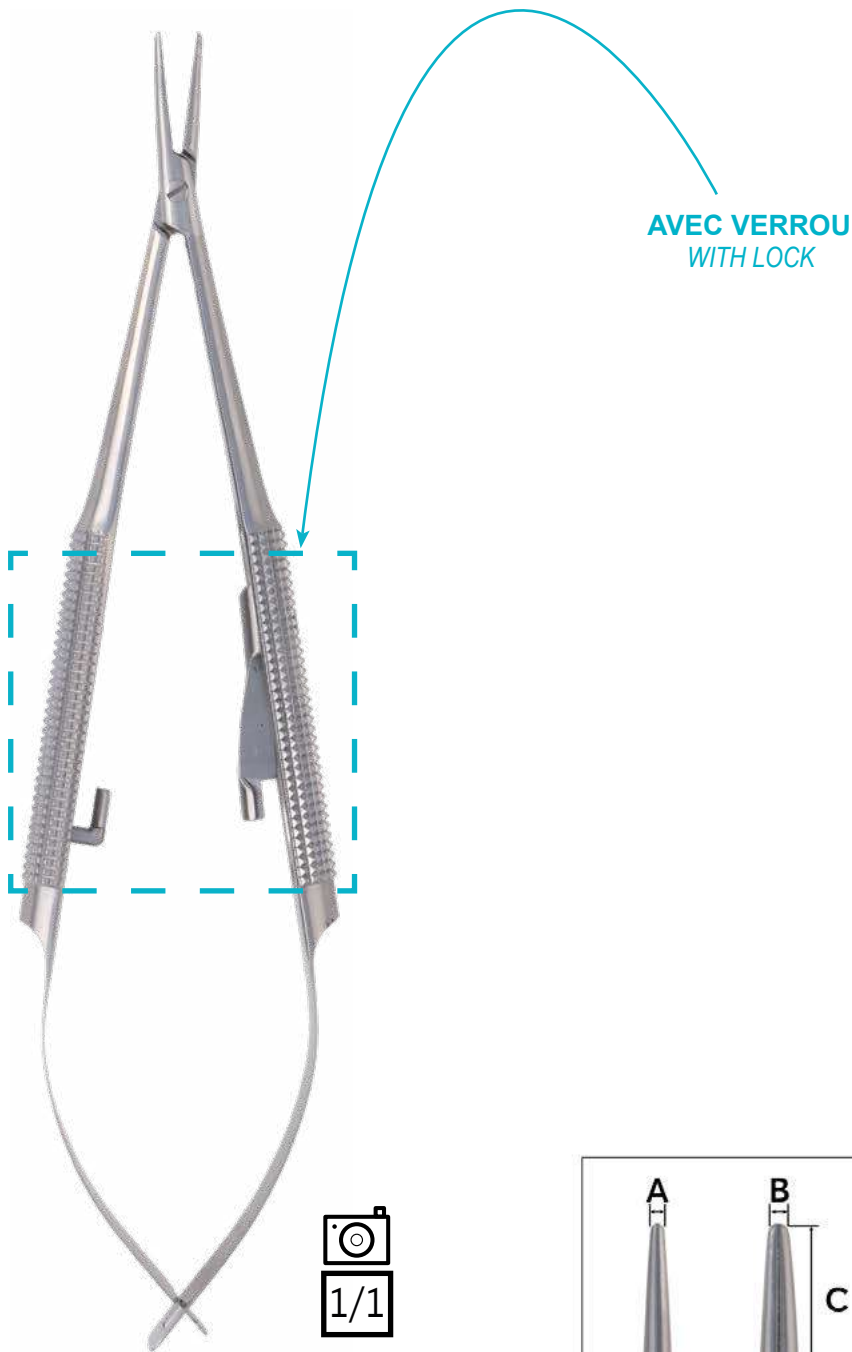

PORTE AIGUILLE MICRO CASTROJIEVO 1,3 x 2 x 12 x 210 MM DROIT CORPS ROND A VERROU MORS STRIES TUNGSTENE

P355165 MICRO CASTROJIEVO NEEDLE HOLDER 1,3 X 2 X 12 X 210 MM STRAIGHT ROUND BODY WITH LOCK SERRATED JAWS TUNGSTEN

CORPS ROND
ROUND BODY

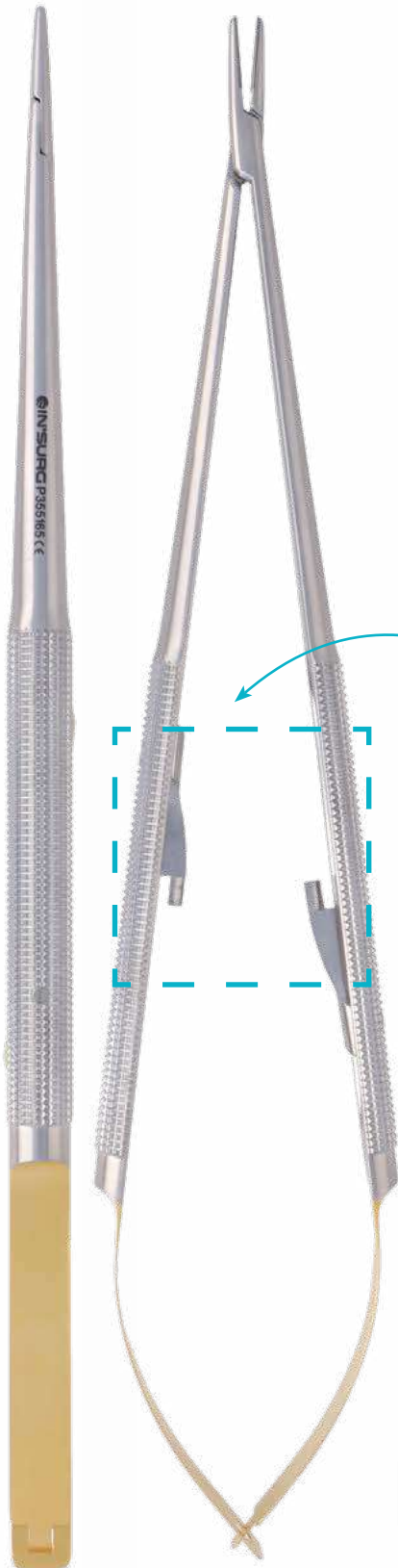

MORS STRIES
SERRATED JAWS

AVEC VERROU
WITH LOCK

SANS VERROU
WITHOUT LOCK

AVEC VERROU
WITH LOCK

SANS VERROU
WITHOUT LOCK

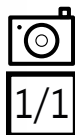

1,3 X 2 X 12 X 180 MM

DROIT
STRAIGHT

COURBE
CURVED

P355222

P355159

P355160

P355158

1,3 X 2 X 12 X 210 MM

DROIT
STRAIGHT

COURBE
CURVED

P355165

P355163

P355164

P355162

PORTE AIGUILLE MICRO JACOBSON 1,6 x 2,3 x 12 x 180 MM DROIT CORPS PLAT
 A VERROU MORS LISSES TUNGSTENE

P355170 MICRO JACOBSON NEEDLE HOLDER 1,6 X 2,3 X 12 X 180 MM STRAIGHT FLAT
 BODY WITH LOCK SMOOTH JAWS TUNGSTEN

CORPS PLAT
 FLAT BODY

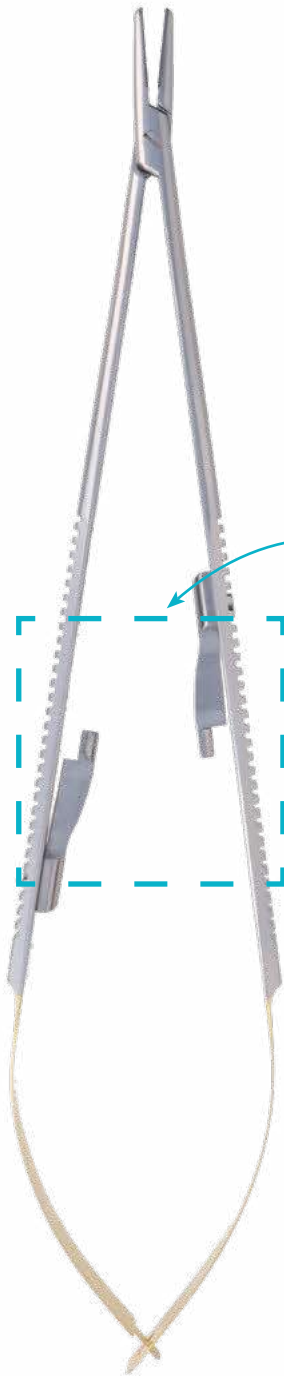

MORS LISSES
 SMOOTH JAWS

AVEC VERROU
 WITH LOCK

SANS VERROU
 WITHOUT LOCK

1,6 X 2,3 X 12 X 180 MM

	DROIT STRAIGHT	COURBE CURVED
AVEC VERROU WITH LOCK	P355170	P355168
SANS VERROU WITHOUT LOCK	P355169	P355166

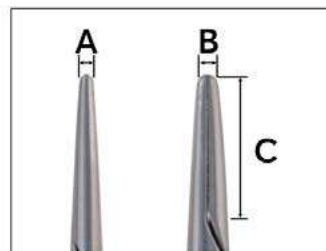

A = EPAISSEUR B = LARGEUR C = LONGUEUR

EXEMPLE : 1,3 X 2 X 12 MM

A B C

PORTE AIGUILLE MICRO JACOBSON 1,6 x 2,3 x 12 x 180 MM COURBE
CORPS PLAT A VERROU MORS LISSE TUNGSTENE

P355167 MICRO JACOBSON NEEDLE HOLDER 1,6 X 2,3 X 12 X 180 MM CURVED
FLAT BODY WITH LOCK SMOOTH JAWS TUNGSTEN

CORPS PLAT FLAT BODY

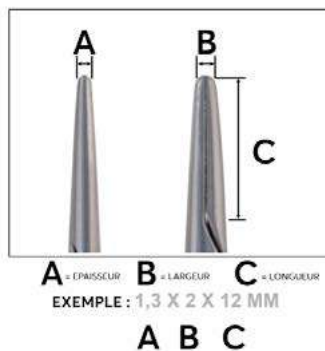
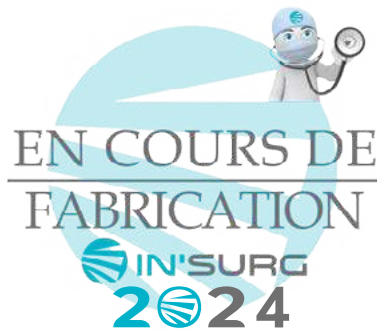

PORTE AIGUILLE MICRO JACOBSON 1,2 x 1,6 x 12 x 185 MM COURBE
CORPS PLAT A VERROU MORS DIAMANTES

P355172 MICRO JACOBSON NEEDLE HOLDER 1,2 X 1,6 X 12 X 185 MM CURVED
FLAT BODY WITH LOCK DIAMOND JAWS

CORPS PLAT
FLAT BODY

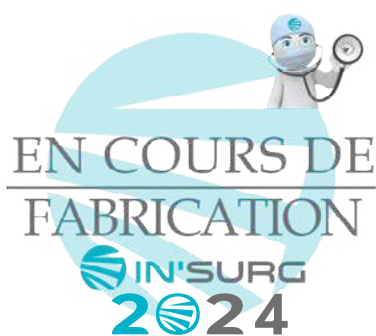

MORS DIAMANTES
DIAMOND JAWS

1,2 X 1,6 X 12 X 185 MM

	DROIT STRAIGHT	COURBE CURVED
AVEC VERROU WITH LOCK	P355174	P355172
SANS VERROU WITHOUT LOCK	P355173	P355171

1,2 X 1,6 X 12 X 210 MM

	DROIT STRAIGHT	COURBE CURVED
AVEC VERROU WITH LOCK	P355183	P355176
SANS VERROU WITHOUT LOCK	P355182	P355175

PORTE AIGUILLE MICRO JACOBSON 1,2 x 1,6 x 12 x 210 MM DROIT CORPS PLAT MORS LISSES TUNGSTENE SANS VERROU

P355180 *MICRO JACOBSON NEEDLE HOLDER 1,2 X 1,6 X 12 X 210 MM STRAIGHT FLAT BODY SMOOTH JAWS TUNGSTEN WITHOUT LOCK*

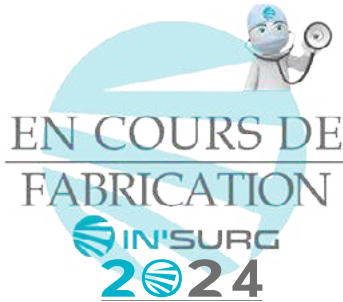

CORPS PLAT
FLAT BODY

MORS LISSES
SMOOTH JAWS

1,2 X 1,6 X 12 X 210 MM

	DROIT <i>STRAIGHT</i>	COURBE <i>CURVED</i>
AVEC VERROU WITH LOCK	P355181	P355179
SANS VERROU WITHOUT LOCK	P355180	P355178

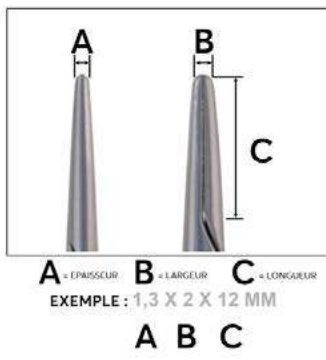

PORTE AIGUILLE MICRO JACOBSON 0,8 x 1,2 x 12 x 150 MM COURBE CORPS ROND
A VERROU MORS DIAMANTES

P355186 MICRO JACOBSON NEEDLE HOLDER 0,8 X 1,2 X 12 X 150 MM CURVED ROUND BODY
WITH LOCK DIAMOND JAWS



MORS DIAMANTES
DIAMOND JAWS

CORPS ROND
ROUND BODY

0,8 X 1,2 X 12 X 150 MM

	DROIT STRAIGHT	COURBE CURVED
AVEC VERROU WITH LOCK	P355190	P355186
SANS VERROU WITHOUT LOCK	P355188	P355184

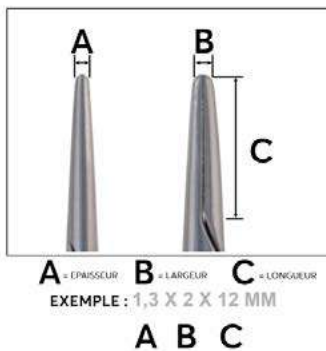
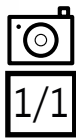

PORTE AIGUILLE MICRO JACOBSON 0,8 x 1,2 x 12 x 210 MM DROIT CORPS ROND MORS DIAMANTES SANS VERROU

P355204 MICRO JACOBSON NEEDLE HOLDER 0,8 X 1,2 X 12 X 210 MM STRAIGHT ROUND BODY DIAMOND JAWS WITHOUT LOCK



MORS DIAMANTES
DIAMOND JAWS

CORPS ROND
ROUND BODY

0,8 X 1,2 X 12 X 180 MM

DROIT
STRAIGHT

COURBE
CURVED

AVEC VERROU
WITH LOCK

P355198

P355194

SANS VERROU
WITHOUT LOCK

P355196

P355192

0,8 X 1,2 X 12 X 210 MM

DROIT
STRAIGHT

COURBE
CURVED

AVEC VERROU
WITH LOCK

P355206

P355202

SANS VERROU
WITHOUT LOCK

P355204

P355200

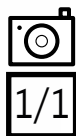

PORTE AIGUILLE MICRO JACOBSON 2 x 3 x 12 x 190 MM COURBE CORPS ROND FORT A VERROU
MORS DIAMANTES

P355208 MICRO JACOBSON NEEDLE HOLDER 2 X 3 X 12 X 190 MM CURVED ROUND BODY FORT WITH LOCK
DIAMOND JAWS

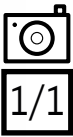

CORPS ROND
ROUND BODY

MORS DIAMANTES
DIAMOND JAWS

DIMENSION
DIMENSION

2 X 3 X 12 X 190 MM

2 X 3 X 17 X 190 MM

2 X 3 X 12 X 230 MM

2 X 3 X 12 X 250 MM

DROIT
STRAIGHT

COURBE
CURVED

P355208

P355209

P355210

P355211

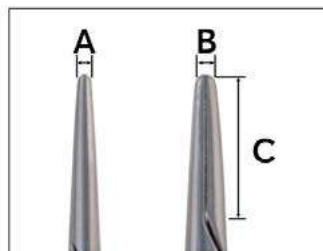

A = ÉPAISSEUR B = LARGEUR C = LONGUEUR

EXEMPLE : 1,3 X 2 X 12 MM

A B C

PORTE AIGUILLE MICRO YASARGIL 185 MM DROIT SANS VERROU

P355212 MICRO YASARGIL NEEDLE HOLDER 185 MM STRAIGHT WITHOUT LOCK

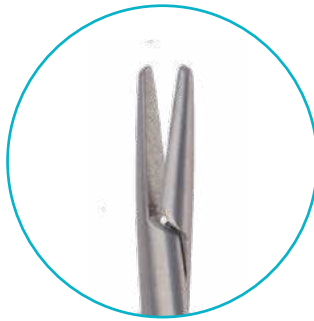

CORPS PLAT
FLAT BODY

DROIT
STRAIGHT

AVEC VERROU
WITH LOCK

P355213

SANS VERROU
WITHOUT LOCK

P355212

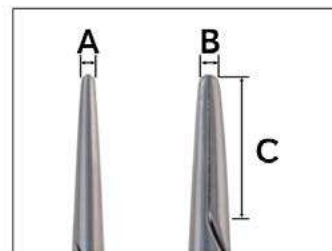

A = EPAISSEUR B = LARGEUR C = LONGUEUR

EXEMPLE : 1,3 X 2 X 12 MM

A B C

PORTE AIGUILLE MICRO YASARGIL 200 MM DROIT BAIONNETTE MANCHE TROUE

P355217 MICRO YASARGIL NEEDLE HOLDER 200 MM BAYONET HOLE HANDLE STRAIGHT

BAIONNETTE BAYONET

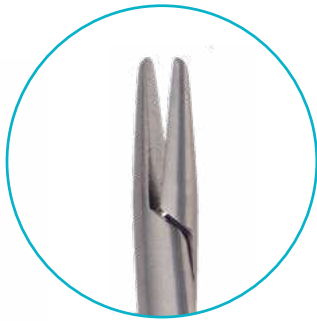

LONGUEUR
LENGTH

200 MM

230 MM

DROIT
STRAIGHT

P355217

P355221

COURBE
CURVED

P355215

P355219

MORS DIAMANTES DIAMOND JAWS

LONGUEUR
LENGTH

200 MM

230 MM

DROIT
STRAIGHT

P355216

P355220

COURBE
CURVED

P355214

P355218

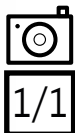

PORTE COTON

COTON APPLICATOR

PORTE COTON 380 MM 1 x 2 GRIFFES

P365222 COTTON APPLICATOR 380 MM 1 X 2 TEETH

PORTE COTON DIAM 1,5 x 120 MM

P365223 COTTON APPLICATOR DIAM 1,5 X 120 MM

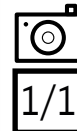
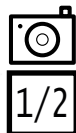
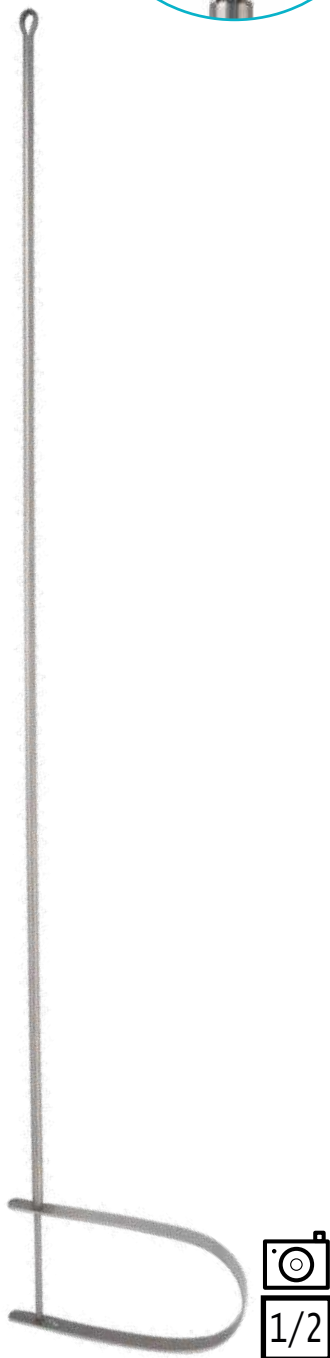

P365224
1,5 X 140 MM

P365225
1,5 X 160 MM

PORTE COTON LATHBURY 140 MM

P365229 LATHBURY COTTON APPLICATOR 140 MM

PORTE COTON FARRELL DIAM 0.9 X 140 MM

P365226 FARRELL COTTON APPLICATOR DIAM 0.9 X 140 MM

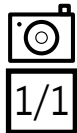
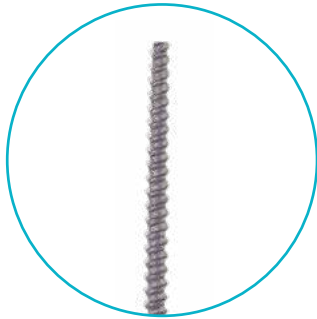

P365228
1,3 X 230 MM

P365227
1.2 X 180 MM

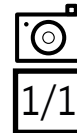

PORTE VIS

SCREW HOLDER

PORTE VIS CASPAR

P375230 CASPAR SCREW HOLDER



SILICONE PROTECTION

PAQUETS DE 100 UNITES
PACKS OF 100 UNITS

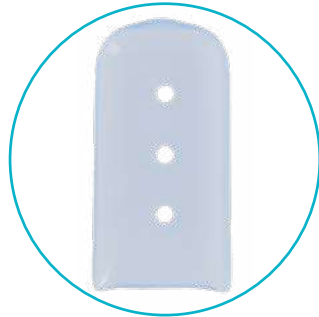

LARGEUR WIDTH	PERFORE PLAT PERFORED FLAT
8 MM	P395234
11 MM	P395235
12 MM	P395238
14 MM	P395240
18 MM	P395243
20 MM	P395244
27 MM	P395247
33 MM	P395248
40 MM	P395249
46 MM	P395250

DIAMETRE DIAMETER	PERFORE ROND PERFORED ROUND
Ø 2 MM	P395253
Ø 3 MM	P395256
Ø 4 MM	P395257
Ø 5 MM	P395262
Ø 6 MM	P395265
Ø 12 MM	P395266

PROTECTEUR SILICONE PR ECARTEUR WEITLANER CARRE PAR 100
P395232 SILICONE PROTECTION SQUARE FOR WEITLANER AUTOSTATIC RETRACTOR BY 100

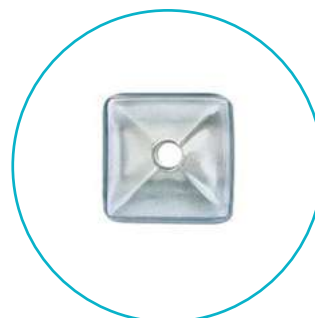

SOMMAIRE

RAPE	1067
<i>RASP</i>	
RAPPROCHEUR COSTAL	1073
<i>RIBS APPROXIMATOR</i>	
REFOULOIR	1074
<i>RAMMER</i>	
ROND DE SEIN	1075
<i>ROUND OF BREASTS</i>	
RONGEUR :	
(PINCE A) DISQUE	1076
<i>DISC RONGEUR</i>	
HYPOPHYSE	1085
<i>HYPOPHYSIS RONGEUR</i>	
LAME VERTEBRALES	1086
<i>LAMINECTOMY RONGEUR</i>	
ORL	1088
<i>ENT RONGEUR</i>	
RUBAN IDENTIFICATEUR	1089
<i>AUTOCLAVABLE IDENTIFICATION TAPE THE ROLL</i>	
RUGINE	1090
<i>RASPATORY</i>	



R

RETRO 'SPECTIVE

Auguste REVERDIN
(2 décembre 1848 - 18 juin 1908)

était un **médecin, chirurgien et professeur** Suisse ayant fondé la **première clinique privée de la ville de Genève**. Il a réalisé de nombreuses **thyroïdectomies** et est l'**inventeur de plusieurs instruments médicaux**, ainsi que **d'équipements d'anesthésie et de désinfection**.



RAPE

RASP

RAPE AUFRICHT 210 MM EN POUSSANT
R015269 AUFRICHT RASP 210 MM BY PUSHING

RAPE FOMON 200 MM DOUBLE N°1-2 TUNGSTENE
R015272 FOMON RASP 200 MM DOUBLE N°1-2 TUNGSTEN



R015269
 210 MM
 EN POUSSANT
 BY PUSHING

R015270
 210 MM
 EN TIRANT
 BY PULLING

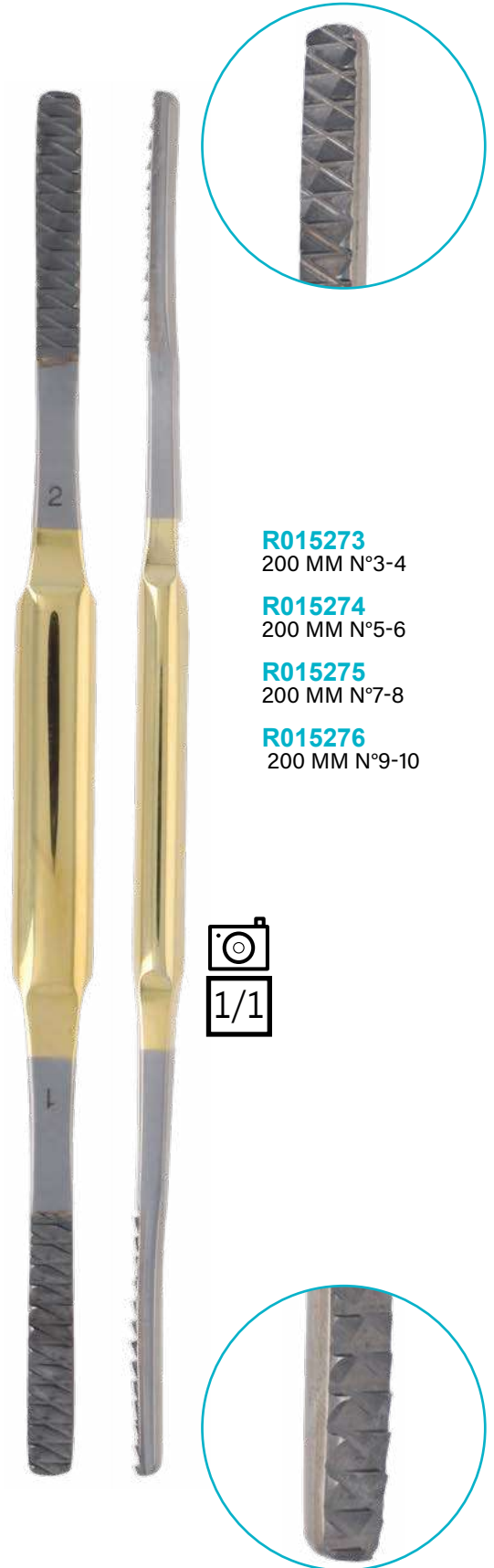
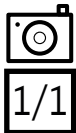

R015273
 200 MM N°3-4

R015274
 200 MM N°5-6

R015275
 200 MM N°7-8

R015276
 200 MM N°9-10

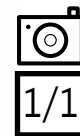

RAPE COTTLE 210 MM
R015271 COTTLE RASP 210 MM

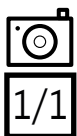

RAPE GALLAHER 160 MM DROITE
R015279 GALLAHER RASP 160 MM STRAIGHT

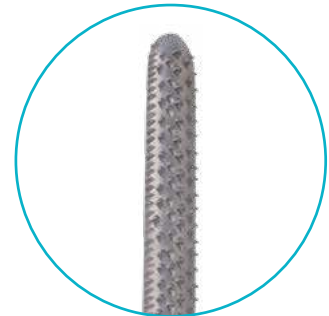

R015279
160 MM
DROITE
STRAIGHT

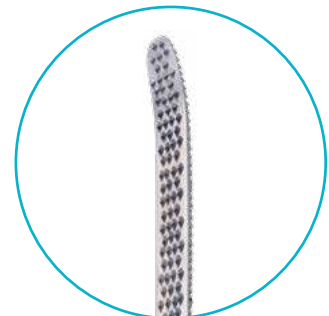

R015277
160 MM
COUDEE A DROITE
RIGHT ANGLED



R015278
160 MM
COUDEE A GAUCHE
LEFT ANGLED

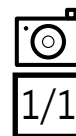

RAPE

RASP

RAPE LEWIS 180 MM

R015280 LEWIS RASP 180 MM

RAPE MALTZ 180 MM

R015282 MALTZ RASP 180 MM

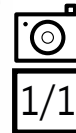
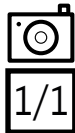

RAPE A OS 20 x 300 MM

R015283 BONE RASP 20 X 300 MM

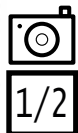
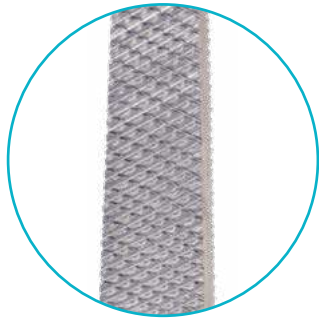

RAPE A OS 220 MM 1 FACE LIME / 1 FACE RAPE

R015284 BONE RASP 220 MM 1 SIDE FILE / 1 SIDE RASP

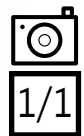

RAPE

RASP

RAPE PUTTI 13 x 240 MM
R015285 PUTTI RASP 13 X 240 MM

RAPE DOUBLE PUTTI
 270 MM PLATE
R015286 PUTTI RASP 270 MM
 DOUBLE FLAT

RAPE PUTTI 300 MM
R015287 PUTTI RASP 300 MM



RAPE STENSTROM OREILLE
COURBE A DROITE

R015289 STENSTROM RASP FOR
EAR CURVED RIGHT

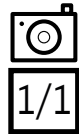

RAPE 3,3 X 150 MM DOUBLE

R015291 RAPE 3.3 X 150 MM
DOUBLE



RAPE RIFLOIR LEMAIRE MANCHE
ACETAL

R015288 LEMAIRE RASP / RIFFLER
ACETAL HANDLE

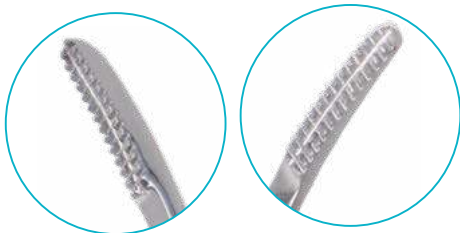
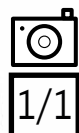

R015289 COURBE A DROITE
CURVED RIGHT

R015290 COURBE A GAUCHE
CURVED LEFT

RAPPROCHEUR COSTAL

RIBS APPROXIMATOR

RAPPROCHEUR COSTAL BAILEY
25 x 180 MM ADULTE

R025292 BAILEY RIBS APPROXIMATOR
25 X 180 MM ADULT



RAPPROCHEUR COSTAL SELLORS
40 x 200 MM VALVES PIVOTANTES

R025294 SELLORS RIBS APPROXIMATOR 40 X 200 MM
SWIVEL BLADES



R015293
20 X 160 MM ENFANT
CHILDREN

PROFONDEUR MORS : 20 MM
JAWS DEPTH : 20 MM

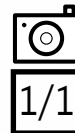
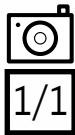

REFOULOIR

RAMMER

REFOULOIR DANIS 200 MM

R045297 DANIS RAMMER 200 MM

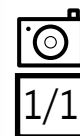

ROND DE SEIN

ROUND BREAST

ROND DE SEIN DIAM 38 MM

R065301 *ROUND BREAST DIAM 38*

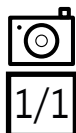

R065302
42 MM

R065303
45 MM

ROND DE SEIN DOUBLE DIAM 38 - 42 MM

R065304 *ROUND BREAST DIAM 38 - 42 MM DOUBLE*

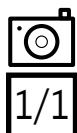

R065305
42 - 45 MM



RONGEUR DISQUE

www.in-surg.fr

R

DISC RONGEUR

RONGEUR DISQUE CASPAR (SCHLESINGER) 2 x 10 x 150 MM DROIT DEMONTABLE NON DETACHABLE

R075312 CASPAR (SCHLESINGER) RONGEUR FOR INTERVERTEBRAL DISC 2 X 10 X 150 MM
STRAIGHT REMOVABLE NOT DETACHABLE



MORS PLEIN
FULL JAWS

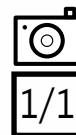

LONGUEUR LENGTH	DROIT STRAIGHT	COUDE HAUT UP ANGLED
2 MM	R075312	R075309
3 MM	R075313	R075310
4 MM	R075314	R075311

RONGEUR DISQUE

DISC RONGEUR

RONGEUR DISQUE FENETRE CASPAR 2 x 12 x 160 MM DROIT DEMONTABLE NON DETACHABLE

R075327 CASPAR RONGEUR FOR INTERVERTEBRAL DISC FENESTRATED
2 X 12 X 160 MM STRAIGHT REMOVABLE NOT DETACHABLE



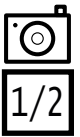

**Garantie totale
5 ANS
sans conditions**



MORS FENETRES
FENESTRATED JAWS

LARGEUR
WIDTH

LONGUEUR
LENGTH

		2 MM	3 MM	4 MM	5 MM	6 MM
 DROIT STRAIGHT	160 MM	R075327	R075328	R075329	R075330	R075331
	180 MM	R075337	R075338	R075339	R075340	R075341
 COUDE HAUT UP ANGLED	160 MM		R075324	R075325	R075326	
	180 MM		R075334	R075335	R075336	
NON DEMONTABLE NON DETACHABLE NO REMOVABLE NO-DETACHABLE						
 COUDE BAS DOWN ANGLED	160 MM		R075322	R075323		
	180 MM		R075332	R075333		
NON DEMONTABLE NON DETACHABLE NO REMOVABLE NO-DETACHABLE						

RONGEUR DISQUE CLOWARD 6 x 10 x 150 MM DROIT

R075344 CLOWARD RONGEUR FOR INTERVERTEBRAL DISC 6 X 10 X 150 MM STRAIGHT



R075343
COUDE HAUT
UP ANGLED



R075342
COUDE BAS
DOWN ANGLED

RONGEUR DISQUE CUSHING 2 x 10 x 180 MM DROIT DEMONTABLE NON DETACHABLE
R075350 CUSHING RONGEUR FOR INTERVERTEBRAL DISC 2 X 10 X 180 MM STRAIGHT REMOVABLE



**Garantie totale
5 ANS
sans conditions**



LARGEUR
WIDTH
2 MM

LONGUEUR
LENGTH



150 MM

R075347

180 MM

R075350

DROIT
STRAIGHT



150 MM

R075346

180 MM

R075349

COUDE HAUT
UP ANGLED



150 MM

R075345

180 MM

R075348

**NON DETACHABLE NON DEMONTABLE
NON-DETACHABLE NON-REMOVABLE**



COUDE BAS
DOWN ANGLED

RONGEUR DISQUE FERRIS 2 x 10 x 180 MM DROIT

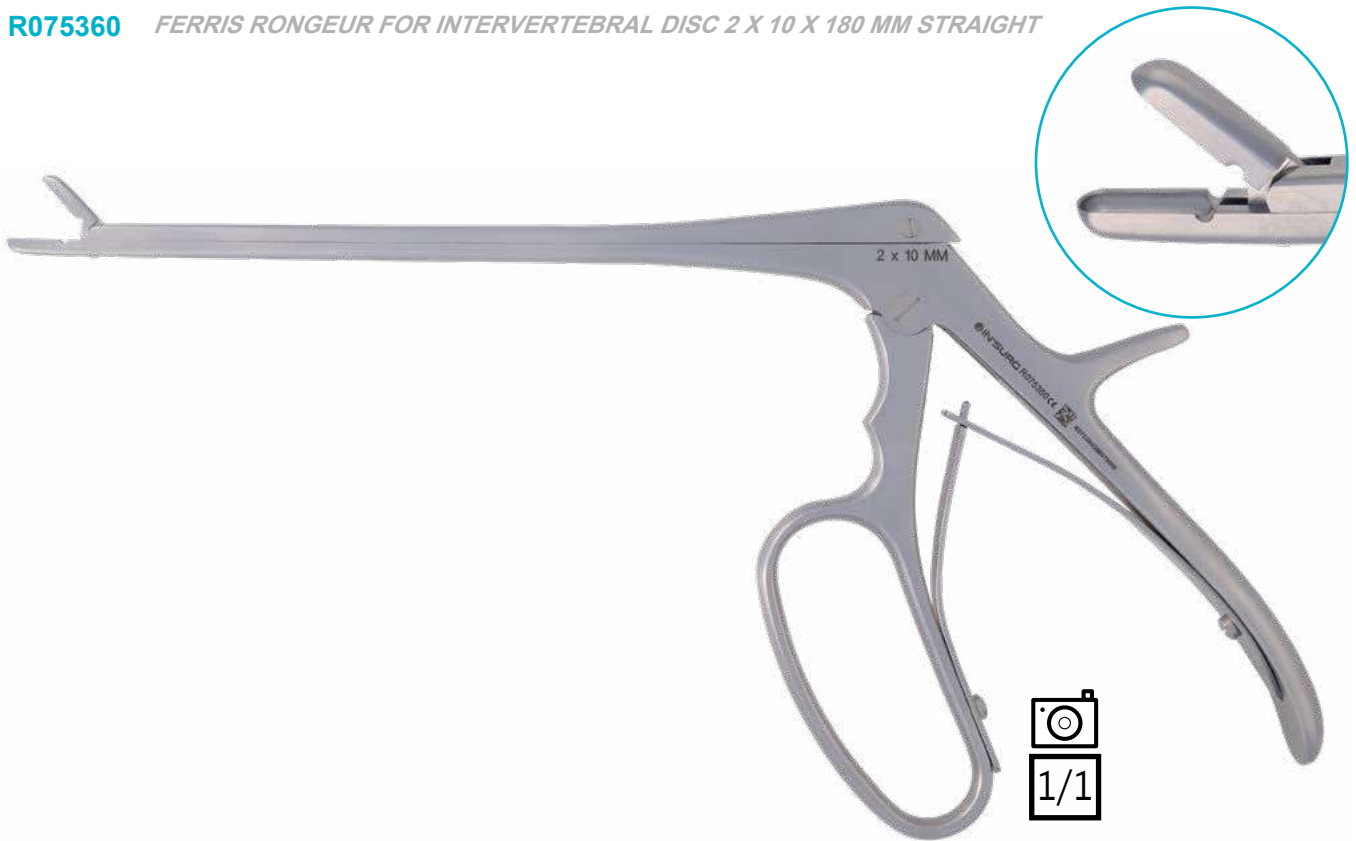
R075360 FERRIS RONGEUR FOR INTERVERTEBRAL DISC 2 X 10 X 180 MM STRAIGHT



LARGEUR X LONGUEUR MORS
WIDTH X LENGTH JAWS

		LARGEUR X LONGUEUR MORS WIDTH X LENGTH JAWS				
		2 X 10 MM	3 X 10 MM	4 X 10 MM	6 X 10 MM	6 X 12 MM
LONGUEUR LENGTH 	180 MM	R075360	R075361	R075362		R075363
	250 MM		R075366			R075367
DROIT STRAIGHT 	180 MM	R075355	R075356	R075357	R075358	
	250 MM		R075364		R075365	
COUDE HAUT UP ANGLED 	180 MM	R075351	R075352	R075353	R075354	

RONGEUR DISQUE

DISC RONGEUR

RONGEUR DISQUE GRUNWALD 3 x 10 x 150 MM DROIT DEMONTABLE NON DETACHABLE

R075372 GRUNWALD RONGEUR FOR INTERVERTEBRAL DISC 3 X 10 X 150 MM STRAIGHT REMOVABLE NOT DETACHABLE



**Garantie totale
5 ANS
sans conditions**



	LONGUEUR LENGTH	LARGEUR WIDTH		
		3 MM	5 MM	
DROIT STRAIGHT	150 MM	R075372		
	180 MM	R075375		
	230 MM	R075368		
	250 MM		R075369	
COUDE HAUT UP ANGLED	150 MM	R075371		
	180 MM	R075374		
COUDE BAS DOWN ANGLED	150 MM	R075370	NON DETACHABLE NON DEMONTABLE NON-DETACHABLE NON-REMOVABLE	
	180 MM	R075373		



RONGEUR DISQUE OLDBERG 6 x 180 MM

R075376 *OLDBERG RONGEUR FOR INTERVERTEBRAL DISC 6 X 180 MM*

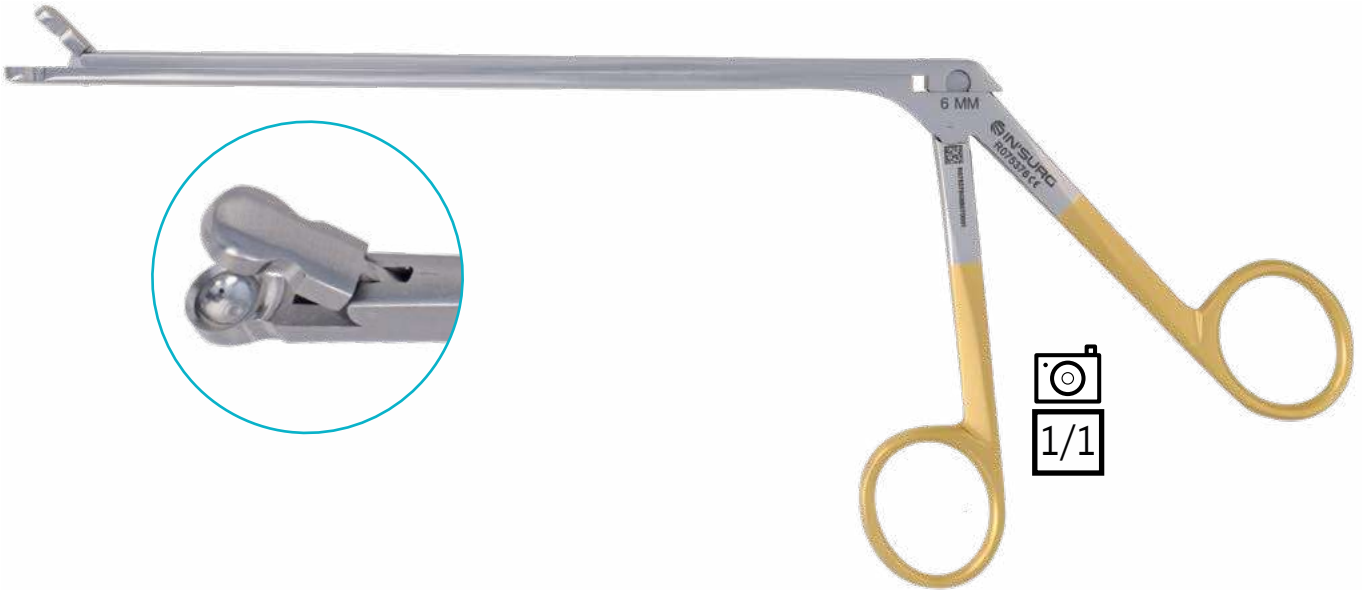

RONGEUR DISQUE SCHLESINGER 1,5 x 150 MM DROIT

R075380 *SCHLESINGER RONGEUR FOR INTERVERTEBRAL DISC 1,5 X 150 MM STRAIGHT*



	LONGUEUR LENGTH	LARGEUR WIDTH			
		1,5 MM	2 MM	3 MM	4 MM
DROIT <i>STRAIGHT</i>	150 MM	R075380	R075381	R075382	R075383
COUDE HAUT <i>UP ANGLED</i>	150 MM	R075379			
COUDE BAS <i>DOWN ANGLED</i>	150 MM	R075378			
	180 MM	R075398			

RONGEUR DISQUE

DISC RONGEUR

RONGEUR DISQUE SPURLING OPEN LINE 4 x 10 x 180 MM COUDE HAUT

R075393 OPEN LINE SPURLING RONGEUR FOR INTERVERTEBRAL DISC 4 X 10 X 180 MM UP ANGLED



**Garantie totale
5 ANS
sans conditions**



LARGEUR DU MORS 4 MM
JAWS WIDTH : 4 MM

LONGUEUR LENGTH	DROIT STRAIGHT	COUDE HAUT UP ANGLED	COUDE BAS DOWN ANGLED
130 MM	R075391	R075390	R075389
180 MM	R075394	R075393	R075392



RONGEUR DISQUE SELVERSTONE 2 x 3 x 150 MM DROIT

R075387 SELVERSTONE RONGEUR FOR INTERVERTEBRAL DISC 2 X 3 X 150 MM STRAIGHT



LARGEUR X LONGUEUR MORS
WIDTH X LENGTH JAWS

DROIT
STRAIGHT

2 X 3 MM	R075387
3 X 5 MM	R075388



RONGEUR DISQUE WAGNER 5,5 x 210 MM DROIT FORT
R075396 *WAGNER RONGEUR FOR INTERVERTEBRAL DISC 5,5 X 210 MM UP STRAIGHT STRONG*

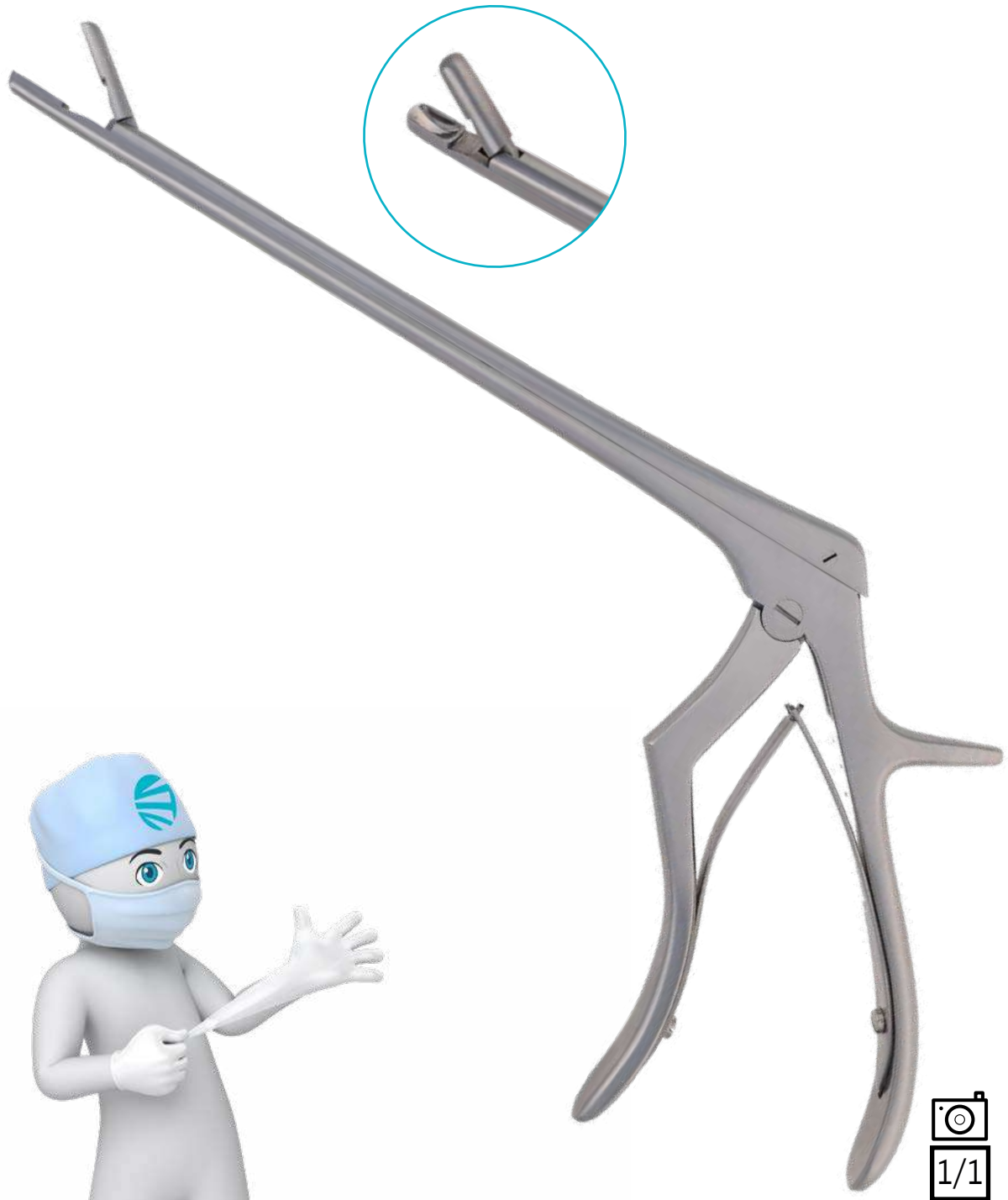

RONGEUR HYPOPHYSE YASARGIL 2,2 x 190 MM DROIT
R095400 YASARGIL HYPOPHYSIS RONGEUR 2,2 X 190 MM STRAIGHT



R095401
3,5 X 190 MM

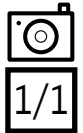

LAMINECTOMY RONGEUR

RONGEUR LAMES VERTEBRALES CLOWARD 3 x 200 MM COUDE A 40°

R105402 CLOWARD LAMINECTOMY RONGEUR 3 X 200 MM ANGLED 40°

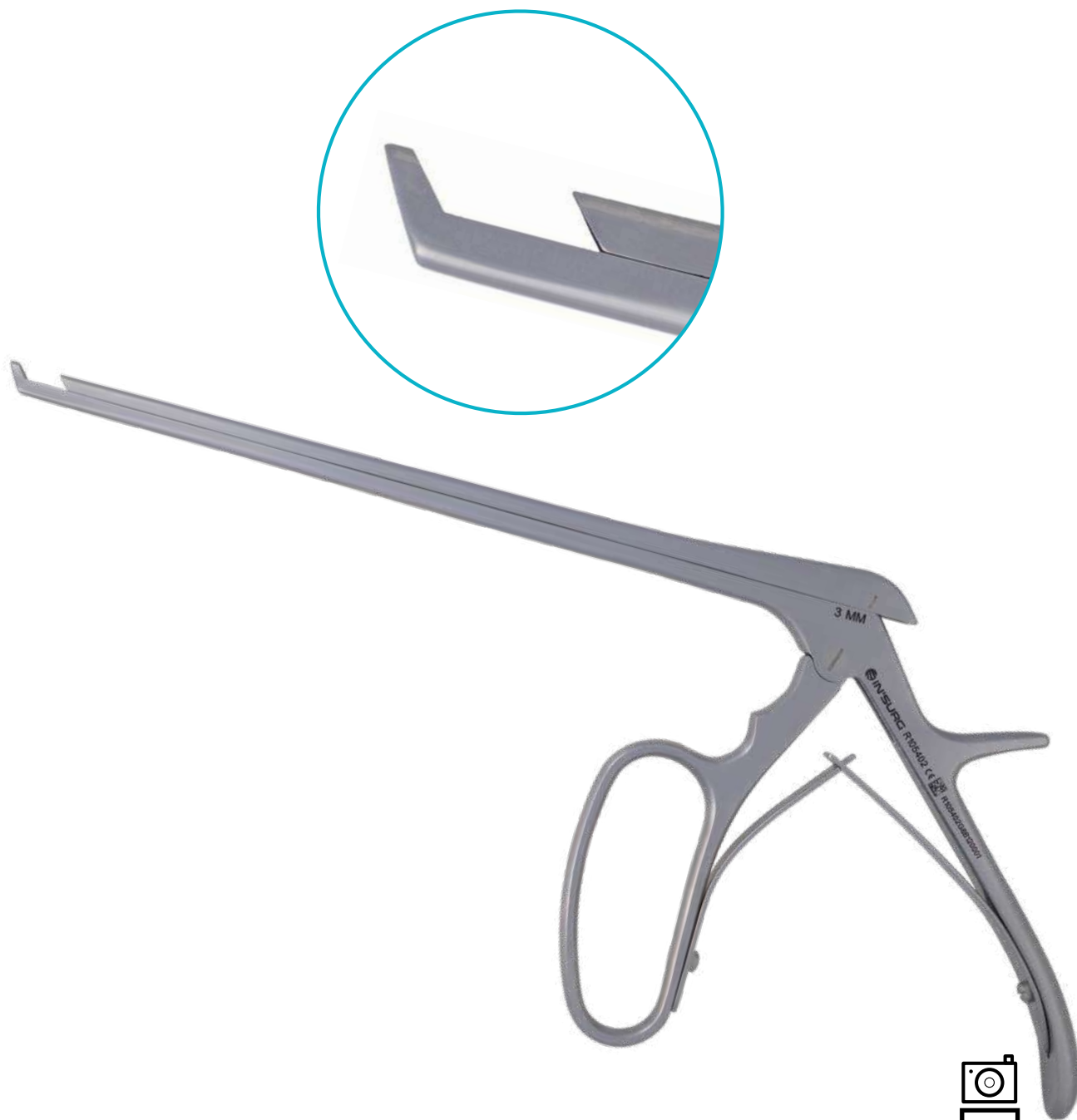

LARGEUR
WIDTH

3 MM

R105402

5 MM

R105403

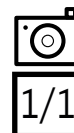

R IN'SURG RONGEUR LAMES VERTEBRALES

LAMINECTOMY RONGEUR

RONGEUR LAMES VERTEBRALES OPEN LINE 1 X 180 MM 40° COUPE EN HAUT DEMONTABLE NON DETACHABLE

R105435 OPEN LINE LAMINECTOMY RONGEUR 1 X 180 MM 40° CUT UPWARDS REMOVABLE NOT DETACHABLE

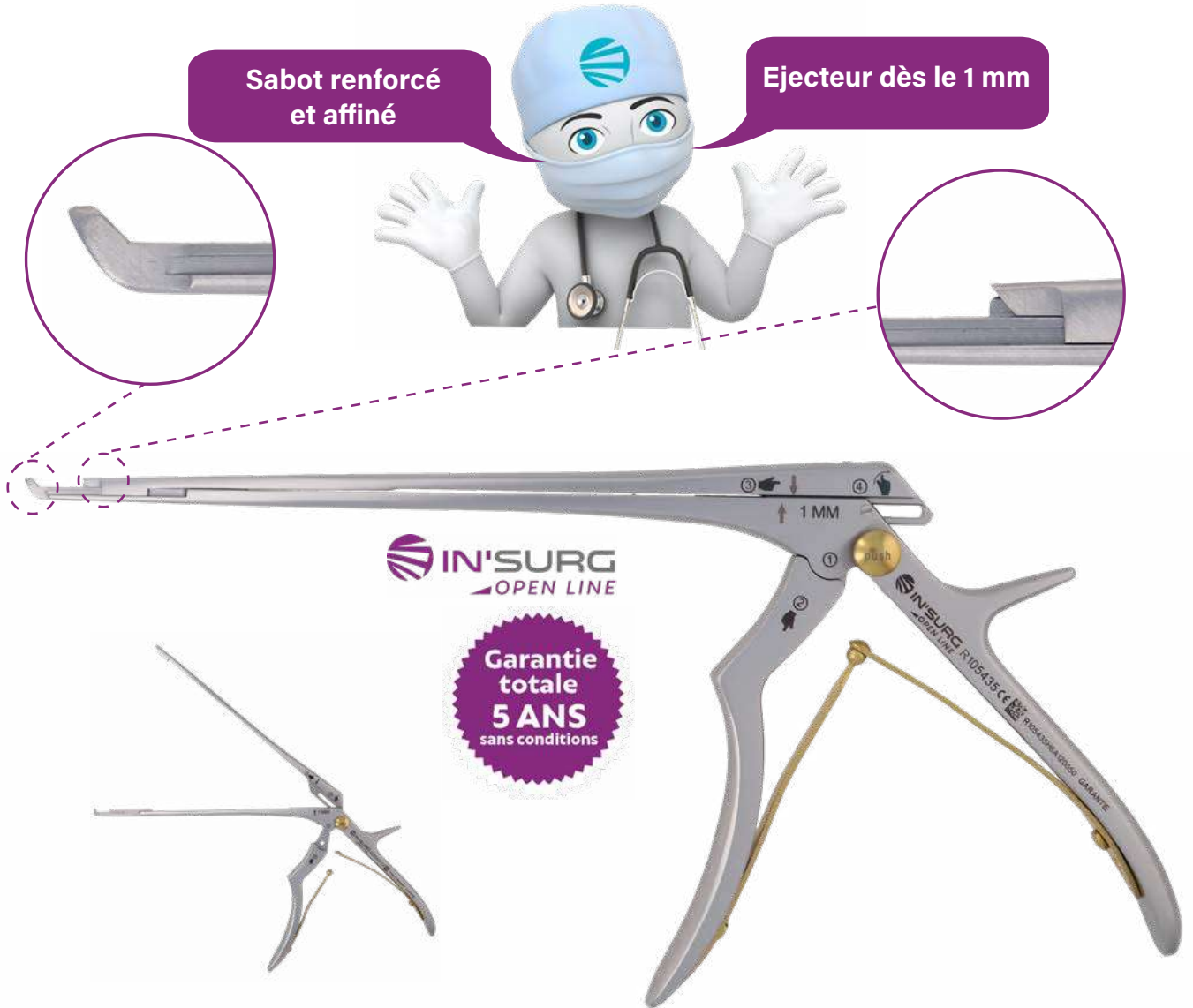

**Garantie totale
5 ANS
sans conditions**

LARGEUR
WIDTH

LONGUEUR
LENGTH

1 MM 2 MM 3 MM 4 MM 5 MM 6 MM

 COUPE EN HAUT 40° 40° CUT UPWARDS	180 MM	R105435	R105439	R105443	R105447	R105451	R105454
	200 MM	R105476	R105477	R105457	R105461	R105465	R105468
	250 MM	R105478	R105470	R105472	R105473	R105474	
 COUPE EN HAUT 90° 90° CUT UPWARDS	180 MM	R105437	R105441	R105445	R105449	R105453	
	200 MM	R105480	R105481	R105459	R105463	R105467	R105469
	250 MM	R105482	R105471	R105483	R105484	R105475	

RONGEUR ORL

www.in-surg.fr

R

ENT RONGEUR

RONGEUR ORL CITELLI 2 X 60 MM

R125480 CITELLI ENT RONGEUR 2 X 60 MM



R125479
1 X 60 MM

R125481
3 X 60 MM

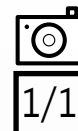

RONGEUR ORL KERISSON 4 X 4 X 90 MM

R125486 KERISSON ENT RONGEUR 4 X 4 X 90 MM

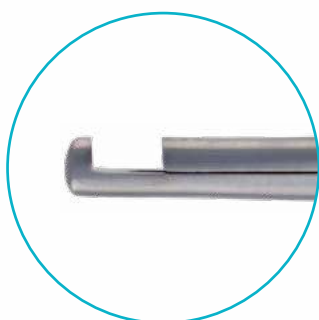

R125485
3 X 3 X 90 MM

R125487
5 X 5 X 90 MM



RUBAN IDENTIFICATEUR

AUTOCLAVABLE IDENTIFICATION TAPE THE ROLL

RUBAN IDENTIFICATEUR AUTOCLAVABLE LE ROULEAU DE 6.20 M BLEU
R135489 AUTOCLAVABLE IDENTIFICATION TAPE THE ROLL OF 6.20 BLUE

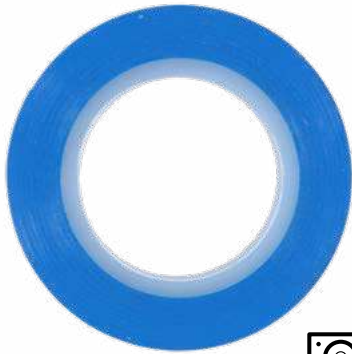

R135491
MARRON
BROWN



R135492
NOIR
BLACK

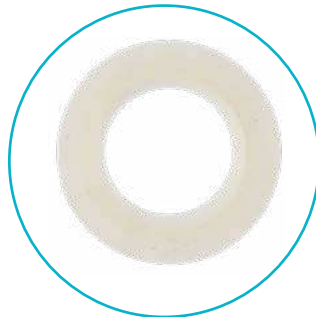

R135488
BLANC
WHITE

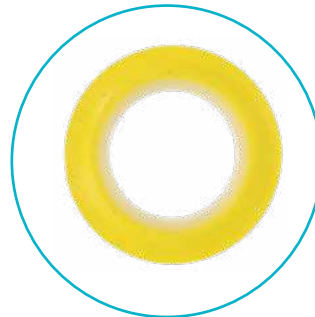

R135490
JAUNE
YELLOW



R135493
ORANGE
ORANGE

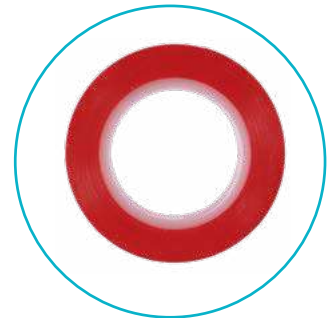

R135494
ROUGE
RED

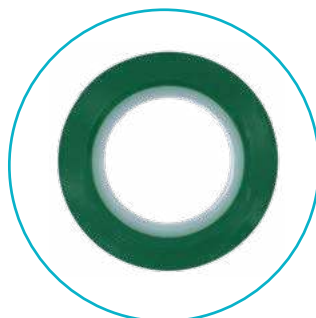

R135495
VERT
GREEN

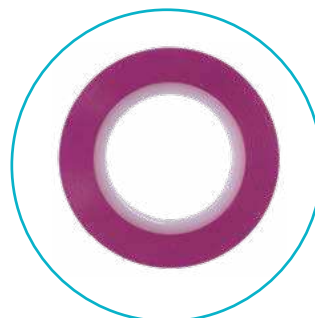

R135496
VIOLET
PURPLE

RUGINE

RASPATORY

www.in-surg.fr

R

RUGINE BUNNEL 4 MM PR TENDON

R145497 BUNNEL RASPATORY 4 MM FOR TENDON



RUGINE CHOMPRET 150 MM DROITE

R145503 CHOMPRET RASPATORY 150 MM STRAIGHT



R145500

COURBE EN FAUCILLE
CURVED

R145501

COURBE A 70°
CURVED AT 70°

R145502

DEMI COURBE
HALF CURVED

RUGINE RASPATORY

RUGINE RACHIS COBB 9 X 240 MM MANCHE HEXAGONALE
R145505 COBB SPINE RASPATORY 9 X 240 MM HEXAGONAL HANDLE

RUGINE CLOVIS VINCENT
10 X 200 MM DROITE

R145504 CLOVIS VINCENT
RASPATORY 10 X 200 MM
STRAIGHT



R145506
13 X 240 MM

R145507
19 X 240 MM

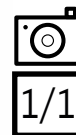
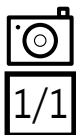

RUGINE RACHIS COBB 4 X 280 MM MANCHE ROND

R145511 COBB SPINE RASPATORY 4 X 280 MM ROUND HANDLE

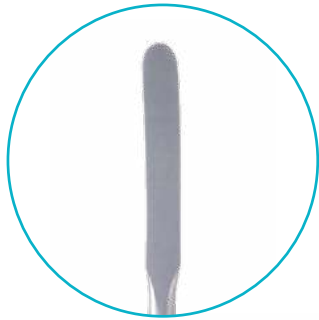

LARGEUR WIDTH	LONGUEUR LENGTH
4 MM	280 MM
6 MM	R145511
8 MM	R145512
	R145513

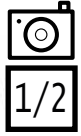

RUGINE RACHIS COBB 10 X 280 MM MANCHE ROND

R145515 COBB SPINE RASPATORY 10 X 280 MM ROUND HANDLE

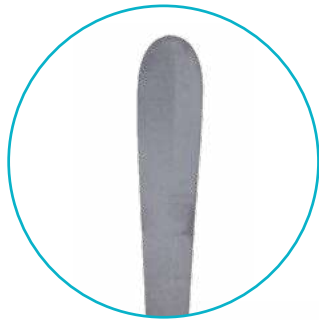

LARGEUR WIDTH	LONGUEUR LENGTH
9 MM	280 MM
10 MM	R145514
12 MM	R145515
	R145516

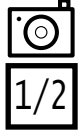

RUGINE RACHIS COBB 19 X 290 MM MANCHE ROND

R145519 COBB SPINE RASPATORY 19 X 290 MM ROUND HANDLE



LARGEUR WIDTH	LONGUEUR LENGTH	
	240 MM	290 MM
9 MM	R145508	
9,5 MM		R145517
13 MM	R145509	R145518
19 MM	R145510	R145519

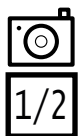

RUGINE RASPATORY

RUGINE COSTAL DOYEN 180 MM COUDEE A DROITE ADULTE
R145520 DOYEN COSTAL RASPATORY 180 MM RIGHT ANGLED ADULT

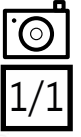

R145520
 180 MM ADULTE COUDEE A DROITE
 180 MM RIGHT ANGLED ADULT



R145524
 180 MM ENFANT COUDEE A DROITE
 180 MM RIGHT ANGLED CHILDREN



R145522
 240 MM ADULTE COUDEE A DROITE
 240 MM RIGHT ANGLED ADULT



R145521
 180 MM ADULTE COUDEE A GAUCHE
 180 MM LEFT ANGLED ADULT



R145525
 180 MM ENFANT COUDEE A GAUCHE
 180 MM LEFT ANGLED CHILDREN



R145523
 240 MM ADULTE COUDEE A GAUCHE
 240 MM LEFT ANGLED ADULT

RUGINE DUCROQUET 15 X 150 MM COURBE
R145526 DUCROQUET RASPATORY 15 X 150 MM CURVED



RUGINE FARABEUF 4 X 160 MM COURBE
R145527 FARABEUF RASPATORY 4 X 160 MM CURVED

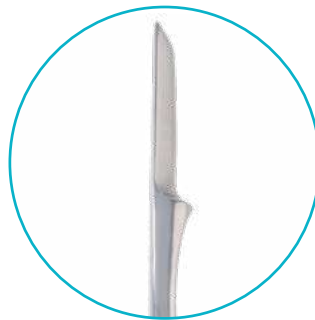
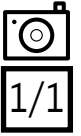

LARGEUR
 WIDTH

COURBE
 CURVED

DROITE
 STRAIGHT

4 MM	R145527	R145528
6 MM	R145529	R145530
8 MM	R145531	R145532
10 MM	R145533	R145534
12 MM	R145535	R145536
14 MM	R145537	R145538

RUGINE FOMON 4 X 170 MM DROITE
R145539 FOMON RASPATORY 4 X 170 MM STRAIGHT

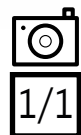

RUGINE FRUCHAUD 10 X 200 MM
BORD INFERIEUR

R145540 FRUCHAUD RASPATORY 10 X 200 MM
BOTTOM EDGE

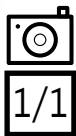
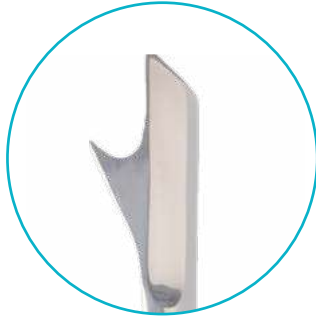

RUGINE
RASPATORY

RUGINE FRUCHAUD 10 X 200 MM
RETROGRADE

R145541 FRUCHAUD RASPATORY 10 X 200 MM
RETROGRADE



RUGINE NASALE JOSEPH 4 X 220 MM
BAIONNETTE

R145542 JOSEPH NASAL RASPATORY 4 X 220 MM
BAYONET

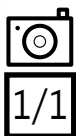

RUGINE NASALE JOSEPH 4 X 160 MM
COURBE

R145543 JOSEPH NASAL RASPATORY 4 X 160 MM
CURVED

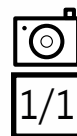

R145544
DROITE
STRAIGHT

RUGINE
RASPATORY

RUGINE LAMBOTTE 5 X 210 MM
R145545 LAMBOTTE RASPATORY 5 X 210 MM

RUGINE LAMBOTTE 11 X 280 MM
R145552 LAMBOTTE RASPATORY 11 X 280 MM



R145546
10 X 210 MM

R145547
12 X 210 MM

R145548
14 X 210 MM

R145549
18 X 210 MM

R145550
20 X 210 MM

R145551
25 X 210 MM

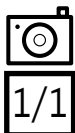

R145554
20 X 280 MM



RUGINE LELIEVRE 4 X 170 MM COURBE
R145555 LELIEVRE RASPATORY 4 X 170 MM
CURVED

RUGINE LEMPERT 4 X 210 MM DEMIE COURBE
R145557 LEMPERT RASPATORY 4 X 210 MM
DEMI CURVED

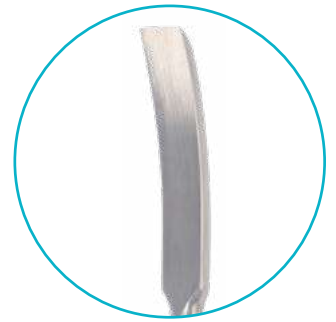

R145556
DROITE
STRAIGHT

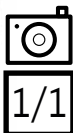

R145558
4 X 180 MM
COURBE
CURVED

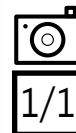

RUGINE LERICHE 9 X 130 MM CONCAVE

R145559 LERICHE RASPATORY 9 X 130 MM CONCAVE



LARGEUR
WIDTH
9 MM
13 MM

CONCAVE

CONVEXE

R145559
R145560

R145561
R145562

RUGINE MAURER COLLIN 6 X 260 MM DEMIE COURBE

R145565 MAURER COLLIN RASPATORY 6 X 260 MM DEMI CURVED



DEMIE COURBE
DEMI-CURVED



COURBE
CURVED



DROITE
STRAIGHT

LARGEUR
WIDTH

6 MM
12 MM

R145565
R145566

R145567
R145568

R145569

RUGINE MAURER 6 X 265 MM FOURCHE COURBE

R145563 MAURER RASPATORY 6 X 265 MM FORK CURVED

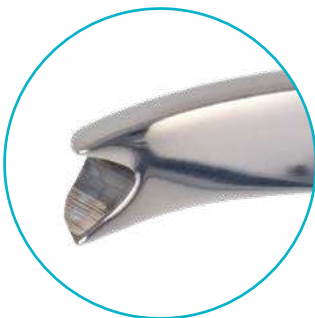

R145564
12 X 265 MM

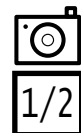

RUGINE

RASPATORY

RUGINE MAXILLO HOWARTH 210 MM SPATULE
R145570 HOWARTH MAXILLO RASPATORY 210 MM SPATULA

RUGINE MAXILLO MOREL FATIO 4 X 220 MM
 DOUBLE
R145571 MOREL FATIO MAXILLO RASPATORY
 4 X 220 MM DOUBLE

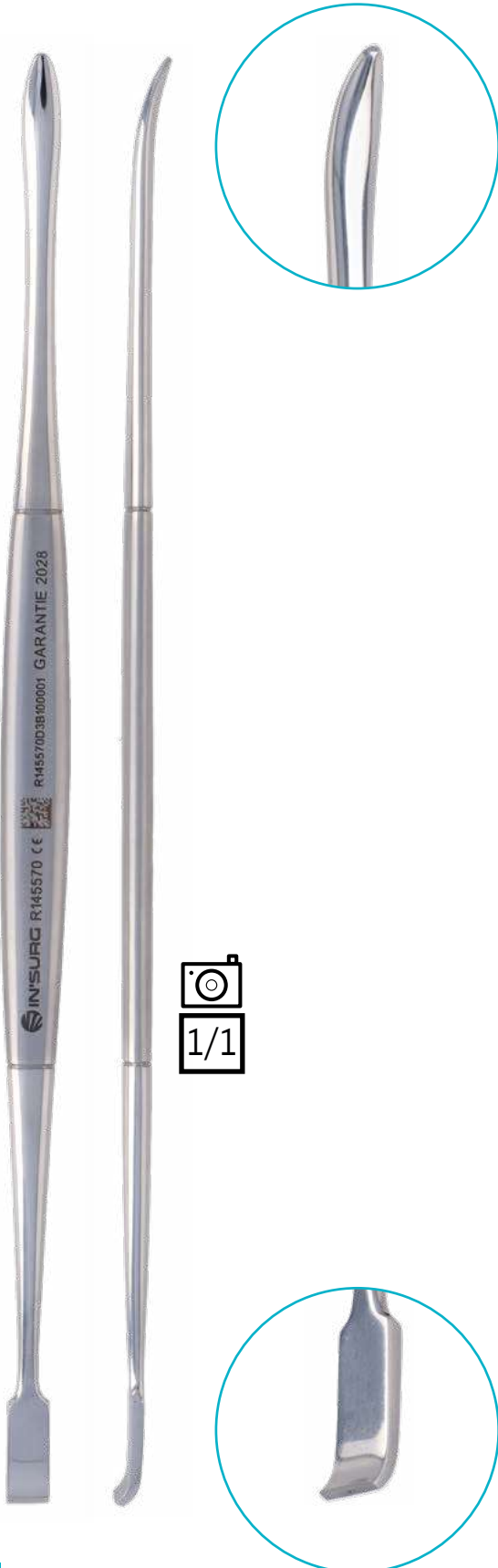

RUGINE MAXILLO OBWEGESER 6 X 175 MM COURBE

R145573 OBWEGESER MAXILLO RASPATORY 6 X 175 MM
CURVED

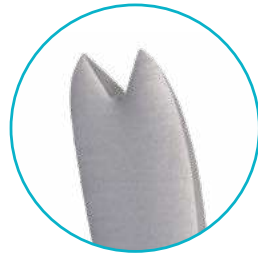

R145573
6 X 175 MM

R145574
7 X 175 MM

R145575
9 X 175 MM

R145576
11 X 175 MM

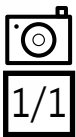

R145573
9 X 175 MM

EN QUEUE D'ARRONDIE
(FOURCHE)
IN ROUND TAIL FORM (FORK)



RUGINE MAXILLO OBWEGESER 5 X 200 MM
COUDEE

R145578 OBWEGESER MAXILLO RASPATORY
5 X 200 MM ANGLED



R145578
5 X 200 MM

R145579
7 X 200 MM

R145580
9 X 200 MM



RUGINE

RASPATORY

RUGINE MAXILLO OBWEGESER 210 MM COURBE
R145581 OBWEGESER MAXILLO RASPATORY 210 MM
 CURVED

RUGINE MAXILLO OBWEGESER 210 MM
 TRES COURBE
R145583 OBWEGESER MAXILLO RASPATORY
 210 MM VERY CURVED



RUGINE MERLE D'AUBIGNE 3 X 240 MM COURBE
R145584 MERLE D'AUBIGNE RASPATORY 3 X 240 MM
 CURVED

RUGINE MERLE D'AUBIGNE 10 X 230 MM DROITE
R145590 MERLE D'AUBIGNE RASPATORY 10 X 230 MM
 STRAIGHT

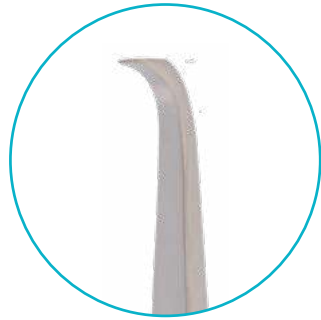

LARGEUR WIDTH	LONGUEUR LENGTH	
	230 MM	240 MM
3 MM		R145584
4 MM		R145585
6 MM		R145586
8 MM		R145587
10 MM		R145588
15 MM	R145589	

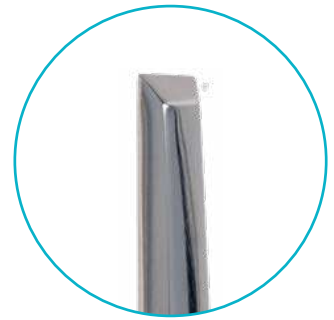
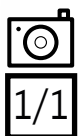

LARGEUR WIDTH	LONGUEUR LENGTH	
	230 MM	240 MM
10 MM	R145590	
12 MM		R145591
15 MM	R145592	



RUGINE

RASPATORY

RUGINE MERLE D'AUBIGNE 7 X 200 MM
POUR LIGAMENT JAUNE

R145593 MERLE D'AUBIGNE RASPATORY 7 X 200 MM
FOR YELLOW LIGAMENT

RUGINE MOLT 4 & 8 MM X 190 MM DOUBLE

R145594 MOLT RASPATORY 4 & 8 MM X 190 MM
DOUBLE

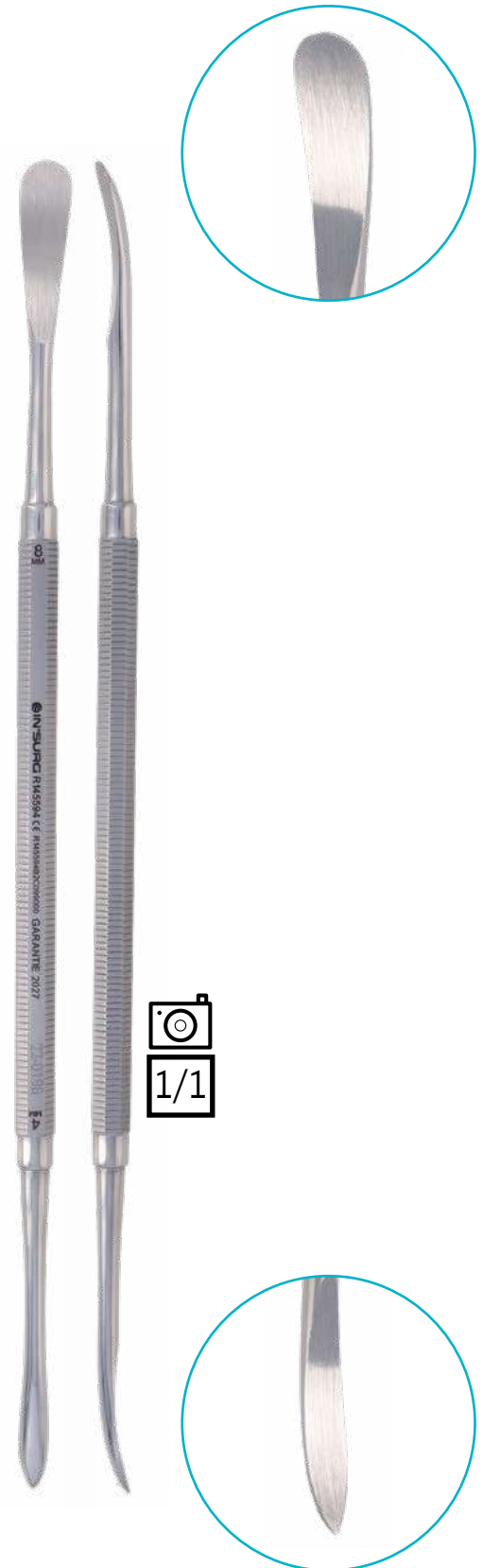

RUGINE MULLER 3 X 185 MM COURBE TRANCHANT DROIT MANCHE CELERON
R145597 MULLER RASPATORY 3 X 185 MM CURVED STRAIGHT EDGE CELERON HANDLE

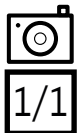

TRANCHANT ROND
ROUND SHARP



TRANCHANT DROIT
STRAIGHT SHARP

R145596
6 X 185 MM
COURBE TRANCHANT ROND
ROUND SHARP CURVE

R145601
14 X 185 MM
COURBE TRANCHANT ROND
ROUND SHARP CURVE

R145599
14 X 195 MM
DROITE TRANCHANT ROND
STRAIGHT SHARP CURVE

R145602
20 X 200 MM
DROITE TRANCHANT ROND
STRAIGHT SHARP ROUND

R145600
6 X 185 MM
DEMIE COURBE TRANCHANT DROIT
STRAIGHT SHARP HALF CURVE

R145595
13 X 185 MM
COURBE TRANCHANT DROIT
CURVED STRAIGHT EDGE

RUGINE

RASPATORY

RUGINE NEURO LANDOLT
REULEN 2,2 X 260 MM

R145603 LANDOLT REULEN NEURO
RASPATORY 2,2 X 260 MM

RUGINE NEURO NICOLA 215 MM

R145607 NICOLA NEURO RASPATORY 215 MM

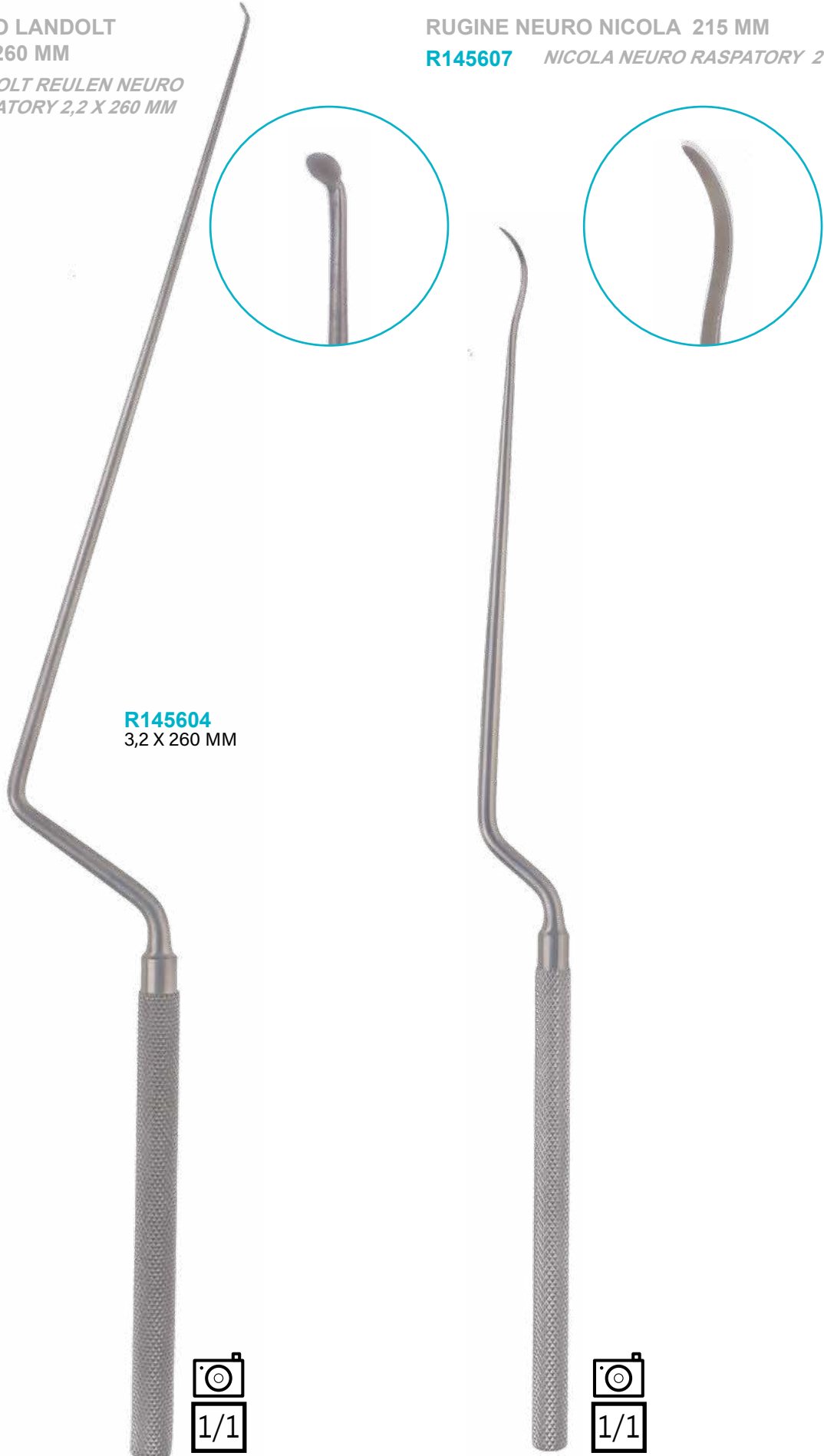

R145604
3,2 X 260 MM



RUGINE OLLIER 6 X 160 MM CONCAVE

R145608 OLLIER RASPATORY 6 X 160 MM CONCAVE

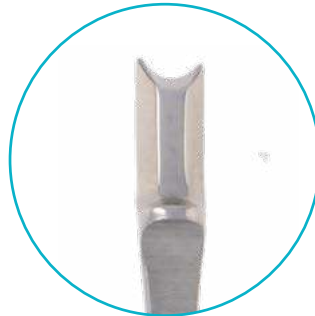
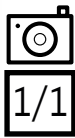

CONCAVE
CONCAVE



CONVEXE
CONVEX

LARGEUR
WIDTH

- 6 MM
- 8 MM
- 10 MM
- 12 MM
- 14 MM

- R145608**
- R145609**
- R145610**
- R145611**
- R145612**

- R145613**
- R145614**
- R145615**
- R145616**
- R145617**

RUGINE NEURO OLLIER 10 X 160 MM

R145618 OLLIER NEURO RASPATORY 10 X 160 MM

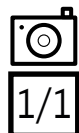

R145619
12 X 160 MM

R145620
14 X 160 MM

RUGINE

RASPATORY

RUGINE DOUBLE OVERHOLT 300 MM 1 COTE ANGLE

R145621 OVERHOLT RASPATORY 300 MM ANGULATED DOUBLE

RUGINE ROUX 5 X 185 MM

R145622 ROUX RASPATORY 5 X 185 MM

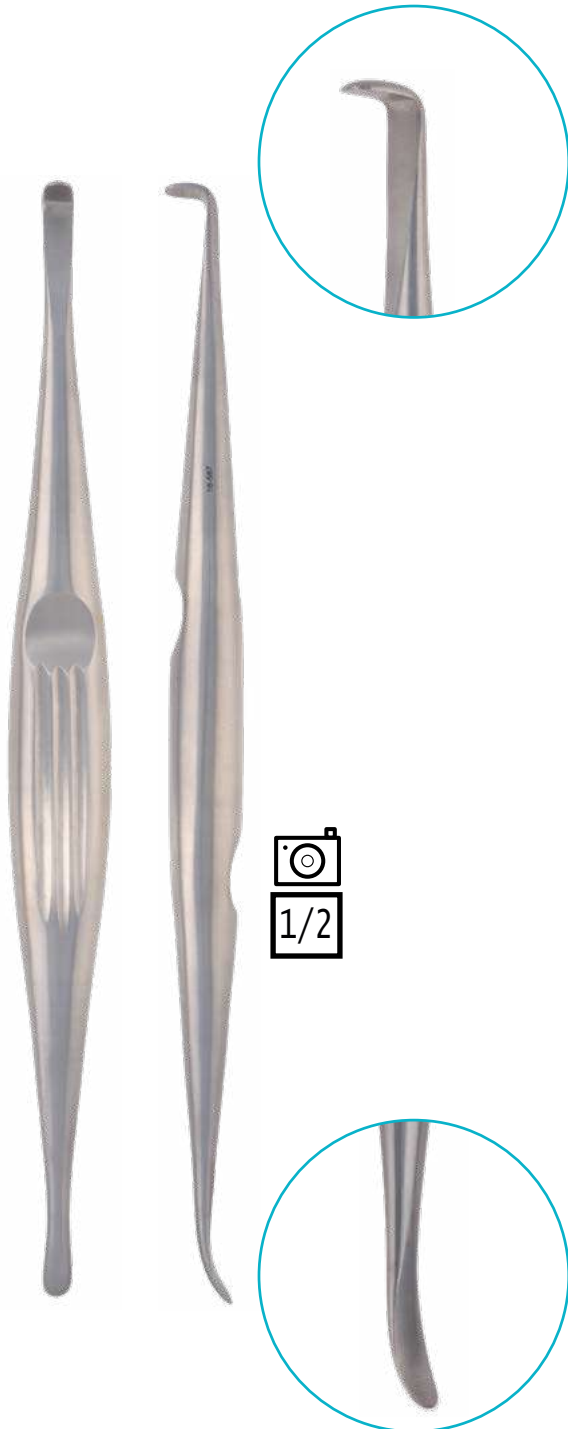

R145623
11 X 185 MM

RUGINE SEBILEAU 4 X 160 MM COURBE

R145625 SEBILEAU RASPATORY 4 X 160 MM CURVED

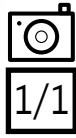

LARGEUR X LONGUEUR
WIDTH X LENGTH

3 X 150 MM
4 X 160 MM



COURBE
CURVED

R145624
R145625



DROITE
STRAIGHT

R145626

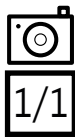

RUGINE
RASPATORY

RUGINE COSTALE SEMB 12 X 195 MM FIGURE 1

R145627 SEMB RIB RASPATORY 12 X 195 MM FIGURE 1

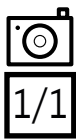

R145628
12 X 210 MM FIGURE 2



R145629
12 X 195 MM FIGURE 3



R145630
13 X 220 MM FIGURE 4



R145631
13 X 215 MM FIGURE 5



R145632
15 X 220 MM FIGURE 6



R145633
15 X 220 MM FIGURE 7

RUGINE TRELAT 7 X 150 MM DROITE

R145634 TRELAT RASPATORY 7 X 150 MM STRAIGHT



RUGINE TRILLAT 8 X 220 MM

R145636 TRILLAT RASPATORY 8 X 220 MM



R145635
6 X 220 MM

R145637
10 X 220 MM

R145638
12 X 220 MM

R145639
14 X 220 MM

R145640
16 X 220 MM

RUGINE YASARGIL 3 X 190 MM COURBE

R145651 YASARGIL RASPATORY 3 X 190 MM CURVED



R145652
TRES COURBE
VERY CURVED

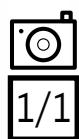

SOMMAIRE

SCIE	1117
<i>SAW</i>	
SEMELLE	1123
<i>SOLE</i>	
SERRE FIL	1124
<i>WIRE TIGHTENER</i>	
SERRE NOEUDS	1126
<i>SNARES</i>	
SONDE	1129
<i>PROBE</i>	
SPATULE	1131
<i>SPATULA</i>	
SPECULUM :	
GYNECO	1135
<i>VAGINAL SPECULA</i>	
ORL	1142
<i>ENT SPECULA</i>	
TRANSPHENOIDALE	1148
<i>TRANSPHENOIDAL SPECULA</i>	
STERILISATION PANIER ET CALAGE	1154
<i>BASKET AND WEDGE</i>	
STRIPPER	1149
<i>STRIPPER</i>	
STYLET	1150
<i>STYLUS</i>	



S

RETRO 'SPECTIVE

Ignace Philippe SEMMELWEIS (1er juillet 1818 - 13 août 1865)

était un **médecin obstétricien** qui démontra l'**utilité du lavage des mains après la dissection d'un cadavre, ou avant d'effectuer un accouchement**, ce qui diminuait le nombre de décès causés par la fièvre puerpérale des femmes après l'accouchement. Il **prescrit l'emploi d'une solution d'hypochlorite de calcium pour le lavage des mains**; le taux de mortalité passe alors de 12 % à 2,4 %.

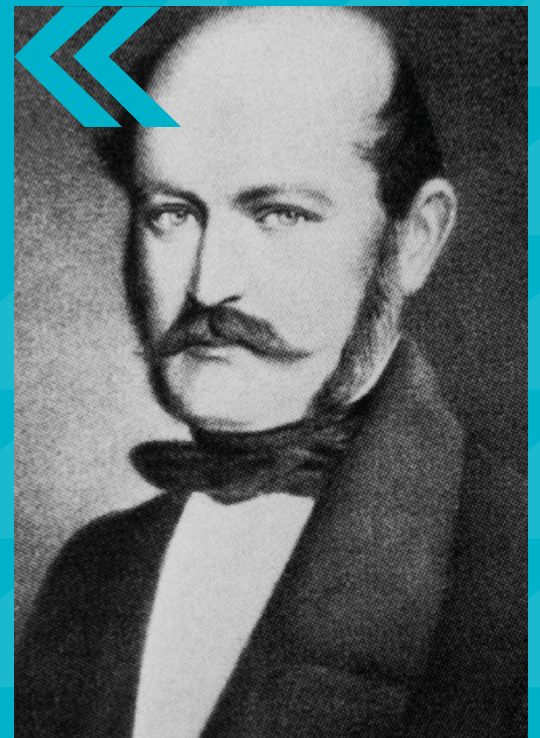

SCIE A PLATRE DE ENGEL MANUELLE
S015659 DE ENGEL PLASTER SAW MANUAL



LAME PR SCIE DOS MOBILE
S015662 BLADE FOR MOBILE BACK SAW

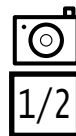

SCIE

SAW

SCIE DOS 300 MM MOBILE
S015661 MOBILE BACK SAW 300 MM

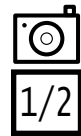

CONDUCTEUR POUR SCIE EN FIL DEMARTEL AVEC SABOT

S015663 DEMARTEL GUIDE FOR WIRE SAW WITH CLOG

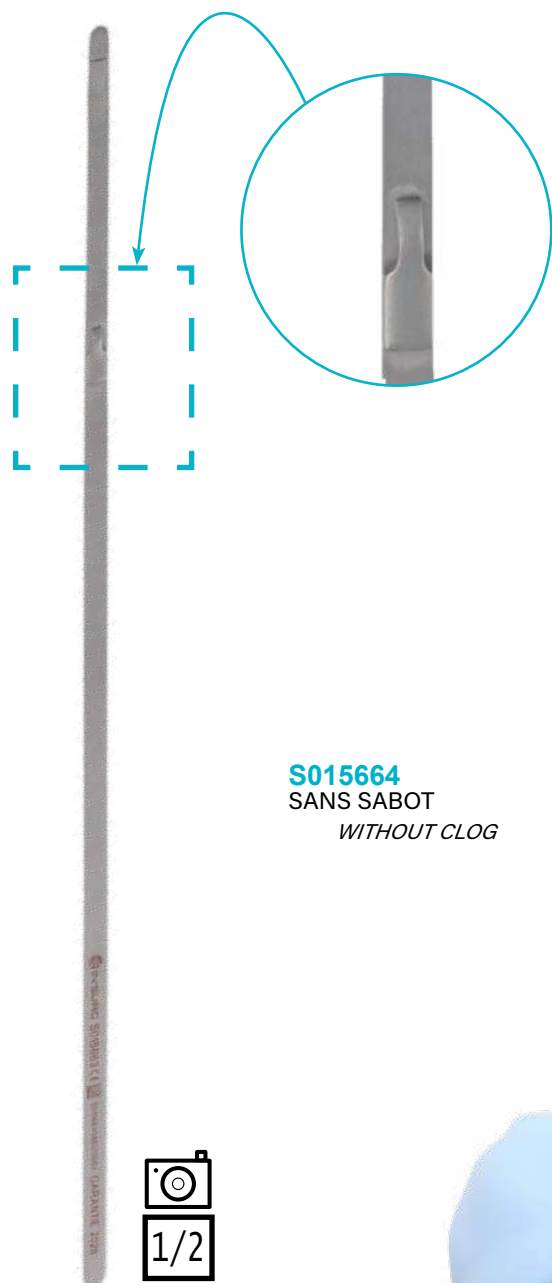

S015664
SANS SABOT
WITHOUT CLOG



SCIE FARABEUF 12 - 15 x 350 MM AVEC 2 LAMES

S015667 FARABEUF SAW 12 - 15 X 350 MM WITH 2 BLADES



LAME PR SCIE FARABEUF 12 MM L'UNITE

S015665 BLADE FOR FARABEUF SAW 12 MM UNIT



S015666
15 MM



SCIE GIGLI 300 MM EN FIL SOUDE OLIVE CRONA SUEDOISE

S015669 GIGLI WIRE SAW 300 MM OLIVE CRONA SWEDISH

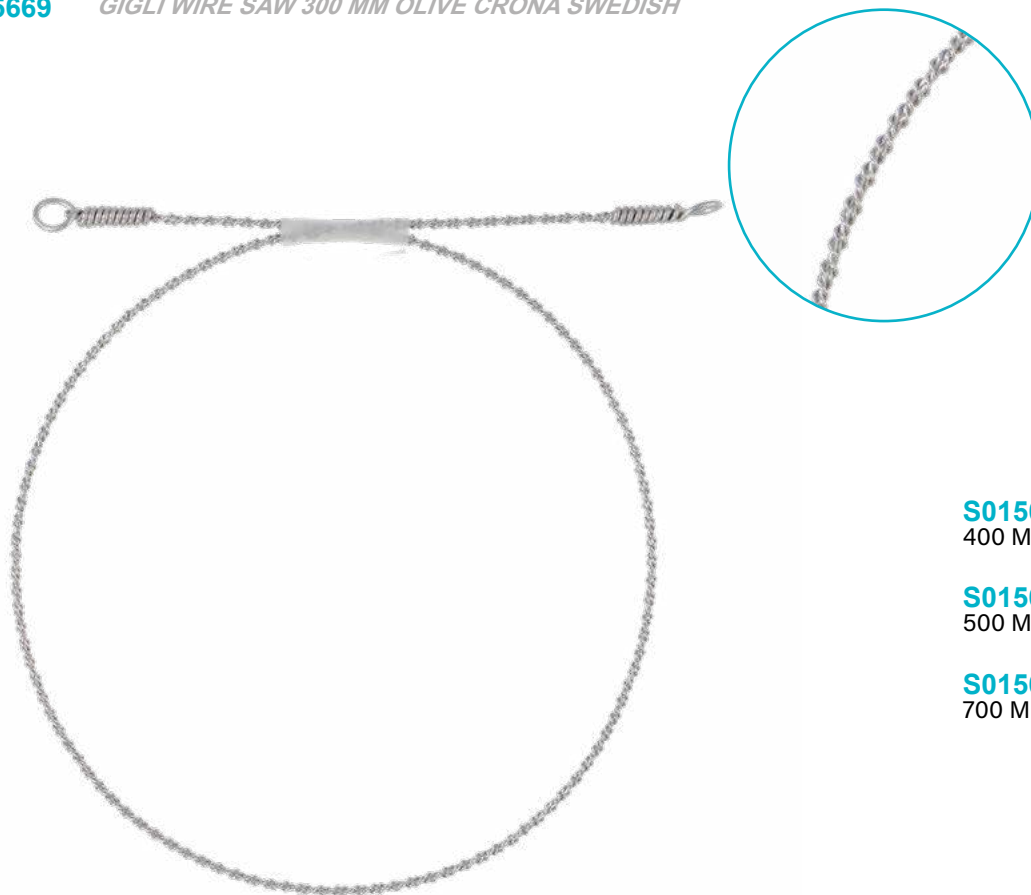

S015670
400 MM

S015671
500 MM

S015668
700 MM

POIGNEE PR SCIE GIGLI L'UNITE

S015672 HANDLE FOR GIGLI WIRE SAW THE UNIT

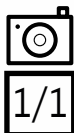

SCIE

SAW

SCIE JOSEPH 200 MM COUDEE A DROITE
S015673 JOSEPH SAW 200 MM RIGHT ANGLED

SCIE JOSEPH 190 MM COUDEE A DROITE
 EN BAIONNETTE

S015675 JOSEPH SAW 190 MM RIGHT ANGLED
 IN BAYONET



S015674
 COUDEE A GAUCHE
 LEFT ANGLED

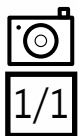

S015676
 COUDEE A GAUCHE
 LEFT ANGLED

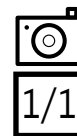

SCIE LANGENBECK 230 MM

S015677 LANGENBECK SAW 230 MM



SCIE POSTEL 235 MM AVEC LAME

S015678 POSTEL SAW 235 MM WITH BLADE



SCIE PERCY RETRACTEUR A AMPUTATION

S015680 PERCY SAW RETRACTOR FOR AMPUTATION

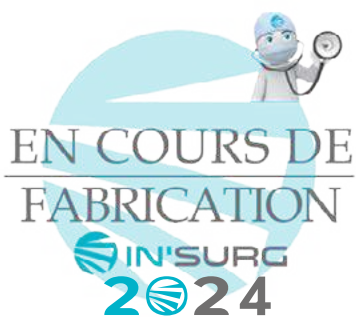

SEMELLE

SOLE

SEMELLE PAUCHET 280 MM

S025681 PAUCHET SOLE 280 MM



SERRE FIL

www.in-surg.fr

S

WIRE TIGHTENER

SERRE FIL DEMEL 270 MM A VIS

S035684 DEMEL WIRE TIGHTENER 270 MM WITH SCEW

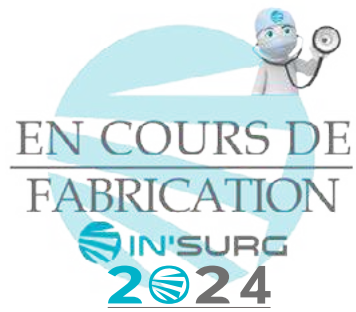

SERRE FIL LOUTE 210 MM
S035685 LOUTE WIRE TIGHTENER 210 MM

SERRE FIL

WIRE TIGHTENER

SERRE FIL TENDEUR DANIS
S035686 DANIS WIRE TIGHTENER TENSIONER

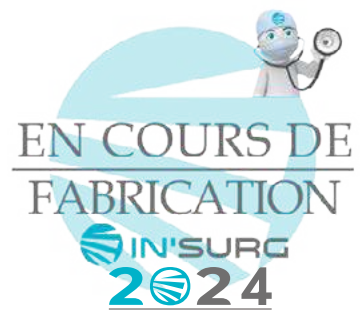
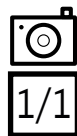

SERRE NOEUDS

www.in-surg.fr

S

SNARES

SERRE NŒUDS BRUNNINGS 280 MM PR AMYGDALES
S045688 BRUNNINGS SNARES 280 MM FOR TONSILS

FILS ACIER PR SERRE NŒUDS
BRUENINGS PAR LOT DE 100
NON STERILE

S045687 WIRE REPLACEMENT FOR
BRUNNINGS SNARES SET OF 100
NOT STERILE

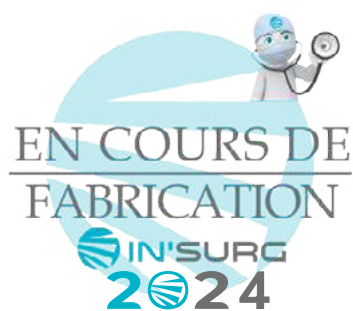

SERRE NOEUDS

SNARES

SERRE NŒUDS KRAUSE VOSS 260 MM
PR POLYPES NEZ

S045706 *KRAUSE VOSS SNARES 260 MM
FOR NASAL POLYPS*

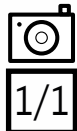

SERRE NŒUDS KRAUSE VOSS 180 MM
PR POLYPES AURICULAIRE

S045705 *KRAUSE VOSS SNARES 180 MM
FOR ATRIAL POLYPS*



ROULEAU FIL D'ACIER PR SERRE NŒUDS 0,2 MM x 10 M

S045689 *ROOL STEEL WIRE FOR SNARES 0,2 MM X 10 M*



LONGUEUR

LENGTH

10 M

DIAMETRE

DIAMETER

Ø 0,2 MM	S045689
Ø 0,3 MM	S045690
Ø 0,4 MM	S045691
Ø 0,5 MM	S045692
Ø 0,6 MM	S045693
Ø 0,7 MM	S045694
Ø 0,8 MM	S045695
Ø 0,9 MM	S045696
Ø 1,0 MM	S045697
Ø 1,2 MM	S045699
Ø 1,5 MM	S045700
Ø 1,8 MM	S045701
Ø 2,0 MM	S045702

FILS PR SERRE NŒUDS KRAUSE VOSS PAR LOT DE 12

S045704 *WIRE FOR KRAUSE VOSS SNARES SET OF 12*

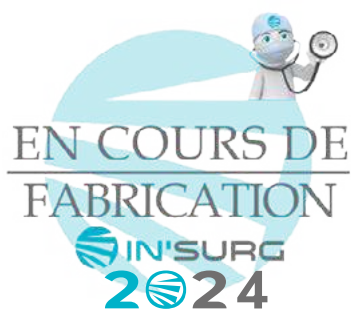

SONDE 140 MM BOUTONNEE
FEUILLE MYRTE

S065740 PROBE 140 MM BUTTONED
MYRTLE LEAF SHAPE

SONDE CANNELEE 120 MM

S065741 FLUTED PROBE 120 MM

SONDE CANNELEE 145 MM
BOUTONNEE

S065744 FLUTED PROBE
145 MM BUTTONED

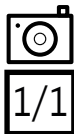

S065742
140 MM

S065743
200 MM

S065745
140 MM
COURBE
CURVED

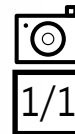
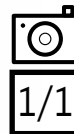

SONDE KONIG 2,5 X 195 MM

S065746 KONIG PROBE 2,5 X 195 MM



S065747
5 X 195 MM

S065748
7 X 195 MM

SPATULE CLOVIS VINCENT 175 MM TYPE A MALLEABLE

S075751 CLOVIS VINCENT SPATULA 175 MM TYPE A MALLEABLE



1/1

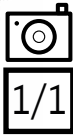

1/1

S075751
175 MM TYPE A

1/1

S075752
190 MM TYPE B

1/1

S075753
205 MM TYPE C

1/1

S075754
205 MM TYPE D

1/1

S075755
195 MM TYPE F

1/1

S075756
220 MM TYPE G

1/1

S075757
230 MM TYPE I

1/1

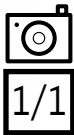
S075758
230 MM TYPE J

1/1

S075759
230 MM TYPE K

1/1

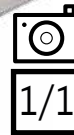
S075760
195 MM TYPE L

1/1

S075761
215 MM TYPE N

1/1

S075762
220 MM TYPE P

SPATULE GUILLAUME 15 x 260 MM A TUMEUR
S075764 *GUILLAUME SPATULA 15 X 260 MM
FOR TUMOR*

SPATULE HEIFETZ 8 X 155 MM MANCHE ROND
S075767 *HEIFETZ SPATULA 8 X 155 MM
ROUND HANDLE*



S075766
20 X 260 MM

S075765
30 X 260 MM

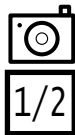

S075768
11 X 155 MM

S075769
14 X 155 MM

S075770
17 X 155 MM

S075771
20 X 200 MM



SPATULE

SPATULA

SPATULE DOUBLE CUSHING 15 - 18 x 180 MM
S075763 CUSHING SPATULA 15 - 18 X 180 MM
 DOUBLE

SPATULE OLIVECRONA 15 X 18 X 180 MM
 EN S CONVEXE
S075775 OLIVECRONA SPATULA 15 X 18 X 180 MM
 S FORM CONVEXE

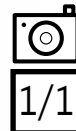

LARGEUR
 WIDTH

CONVEXE

CONCAVE

7 X 9 MM
 11 X 13 MM
 15 X 18 MM
 18 X 22 MM

S075773
S075774
S075775
S075776

S075777
S075778
S075779
S075780

SPATULE DUTAILLIS 200 MM TRCHANTE A DROITE
S075781 *DUTAILLIS SPATULA 200 MM RIGHT SHARP*



SPATULE SICARD 5,5 X 200 MM TRCHANTE
S075783 *SICARD SPATULA 5,5 X 200 MM SHARP*



S075782
TRCHANANT A GAUCHE
LEFT SHARP

SPATULE WILLIGER 5,5 X 170 MM
S075784 *WILLIGER SPATULA 5,5 X 170 MM*



SPECULUM GYNECO COLLIN 16 X 90 MM

S085790 COLLIN VAGINAL SPECULA 16 X 90 MM



LARGEUR X LONGUEUR
WIDTH X LENGTH

16 X 90 MM	S085790
26 X 90 MM	S085791
30 X 90 MM	S085792
30 X 105 MM	S085793
32 X 50 MM	S085794
32 X 105 MM	S085795
35 X 50 MM	S085796
35 X 105 MM	S085797
36 X 170 MM	S085798
38 X 105 MM	S085799
38 X 150 MM	S085800

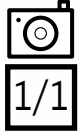

SPECULUM GYNECO COLLIN 16 X 90 MM LASER ISOLE

S085805 COLLIN VAGINAL SPECULA 16 X 90 MM LASER INSULATED

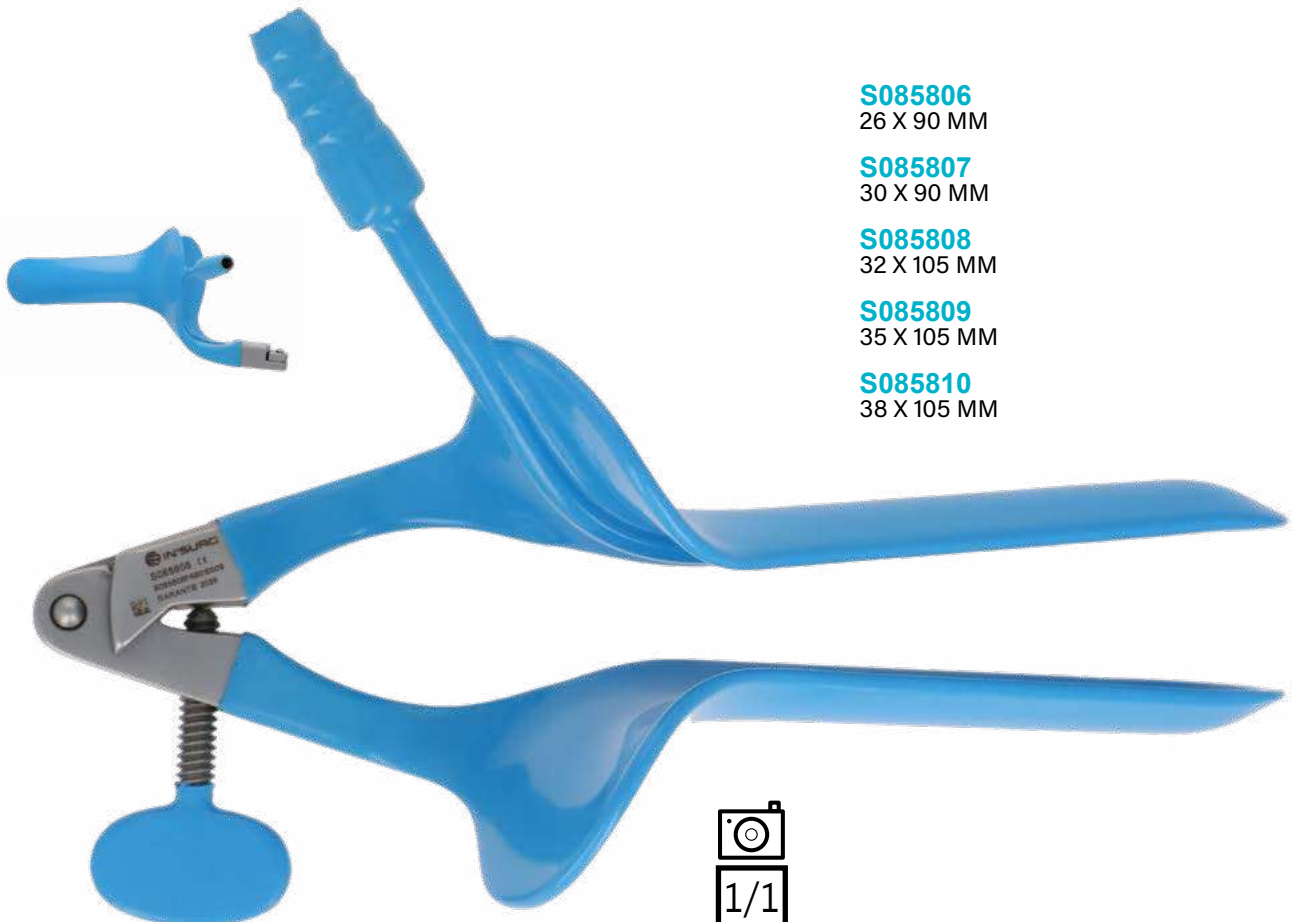

S085806
26 X 90 MM

S085807
30 X 90 MM

S085808
32 X 105 MM

S085809
35 X 105 MM

S085810
38 X 105 MM



SPECULUM GYNECO COLLIN 28 X 90 MM LASER

S085801 COLLIN VAGINAL SPECULA 28 X 90 MM LASER

S085803
35 X 95 MM

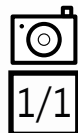

SPECULUM GYNECO COLLIN 35 X 95 MM LASER FIBRE OPTIQUE

S085804 COLLIN VAGINAL SPECULA 35 X 95 MM
OPTICAL FIBER LASER

S085802
30 X 90 MM

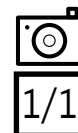

SPECULUM GYNECO CUSCO 36 X 100 MM PLIANT

S085822 CUSCO VAGINAL SPECULA 36 X 100 MM FOLDING



S085816
16 X 100 MM

S085817
20 X 100 MM

S085818
25 X 100 MM

S085819
28 X 100 MM

S085820
30 X 100 MM

S085821
32 X 100 MM



SPECULUM GYNECO CUSCO 16 X 100 MM FIXE

S085811 CUSCO VAGINAL SPECULA 16 X 100 MM FIXED



S085812
25 X 100 MM

S085813
32 X 100 MM

S085814
35 X 100 MM

S085815
40 X 100 MM

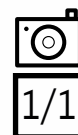

SPECULUM GYNECO JAYLE 38 x 100 MM PARALLELE
S085828 JAYLE VAGINAL SPECULA 38 X 100 MM PARALLEL

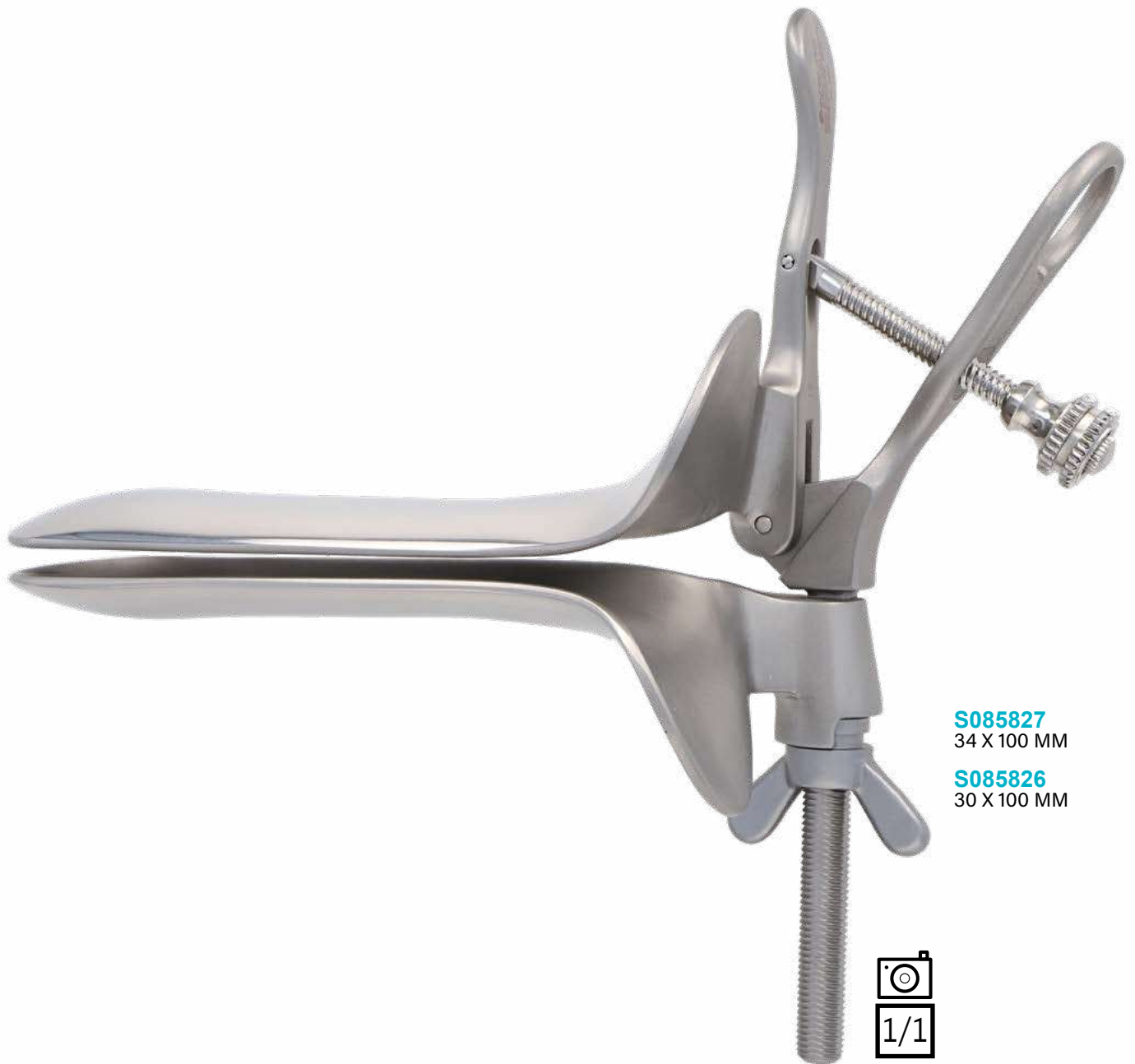

S085827
34 X 100 MM

S085826
30 X 100 MM

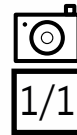

SPECULUM GYNECO TRELAT 45 x 115 MM PARALLELE
S085831 TRELAT VAGINAL SPECULA 45 X 115 MM PARALLEL



1/1

SPECULUM GYNECO SIMS DOUBLE

S085823 *SIMS VAGINAL SPECULA DOUBLE*

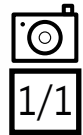

SPECULUM GYNECO GRAVES 20 x 75 MM

S085824 *GRAVES VAGINAL SPECULA 20 X 75 MM*



S085825
35 X 95 MM

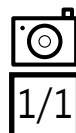

SPECULUM GYNECO

VAGINAL SPECULA

SPECULUM GYNECO KOGAN 240 MM A CREMAILLERE
S085829 KOGAN VAGINAL SPECULA 240 MM WITH RATCHET

SPECULUM GYNECO KOGAN 240 MM
 SANS CREMAILLERE

S085830 KOGAN VAGINAL SPECULA 240 MM
 WITHOUT RATCHET

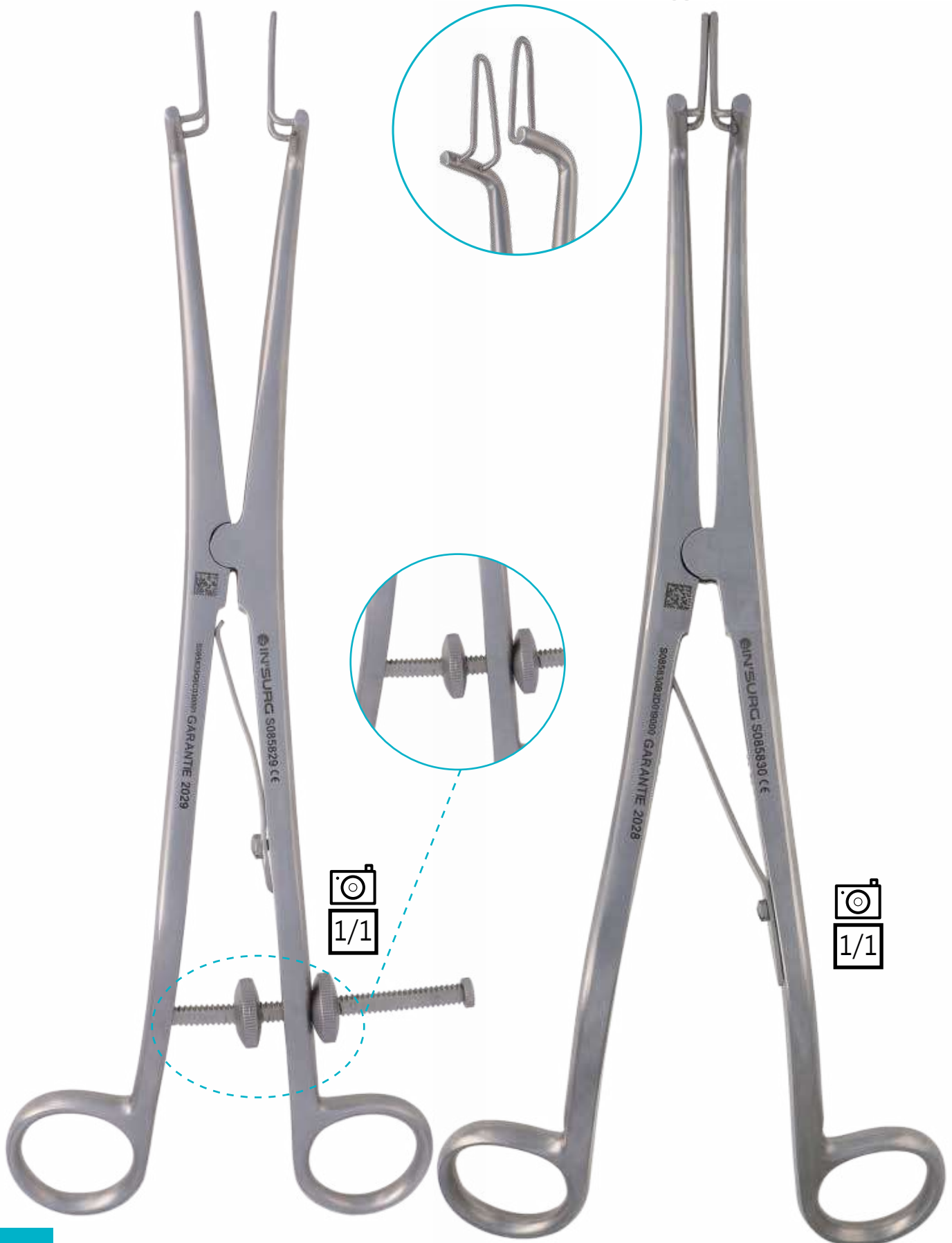

ENT SPECULA

**SPECULUM O.R.L BRUENINGS COMPLET
PR AURICULAIRE**

S095832 BRUENINGS ENT SPECULA
COMPLET FOR AURICULAR



**SPECULUM O.R.L HARTMANN JEU DE 4
PR AURICULAIRE**

S095833 HARTMANN ENT SPECULA
SET OF 4 FOR AURICULAR



**SPECULUM O.R.L LE MEE DIAM 1 MM
PR AURICULAIRE**

S095835 LE MEE ENT SPECULA DIAM
1 MM FOR AURICULAR



S095836
Ø 2 MM

S095837
Ø 3 MM

S095838
Ø 4 MM

S095839
Ø 5 MM

S095840
Ø 6 MM

**SPECULUM O.R.L LE MEE JEU DE 6
PR AURICULAIRE**

S095834 LE MEE ENT SPECULA SET
OF 6 FOR AURICULAR



SPECULUM O.R.L SIEGLE COMPLET PR AURICULAIRE
S095841 SIEGLE ENT SPECULA COMPLET FOR AURICULAR



SPECULUM O.R.L TOYNBEE JEU DE 3 PR AURICULAIRE
S095843 TOYNBEE ENT SPECULA SET OF 3 FOR AURICULAR



SPECULUM O.R.L COTTLE 52 X 150 MM PR RHINOLOGIE

S095844 COTTLE ENT SPECULA 52 X 150 MM FOR RHINOLOGY

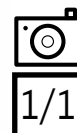

SPECULUM O.R.L DUPLAY ADULTE PR RHINOLOGIE

S095845 DUPLAY ENT SPECULA ADULT FOR RHINOLOGY



S095846
ENFANT
CHILDREN

S095847
NOURISSON
BABY



SPECULUM O.R.L HARTMANN HALL 25 x 150 MM PR RHINOLOGIE

S095848 HARTMANN HALL ENT SPECULA 25 X 150 MM FOR RHINOLOGY



S095848
25 X 150 MM



S095849
30 X 150 MM



S095850
35 X 150 MM



SPECULUM O.R.L EN FIL PALMER

S095857 PALMER ENT SPECULA IN WIRE



SPECULUM O.R.L KILLIAN 35 x 130 MM PR RHINOLOGIE

S095851 KILLIAN ENT SPECULA 35 X 130 MM FOR RHINOLOGY



S095852
50 X 130 MM

S095853
65 X 130 MM

S095854
75 X 130 MM

S095855
90 X 130 MM



VIS PR SPECULUM O.R.L KILLIAN L'UNITE PR RHINOLOGIE

S095856 SCREW FOR KILLIAN ENT SPECULA UNIT FOR RHINOLOGY

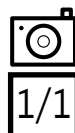

SPECULUM ORL

ENT SPECULA

SPECULUM O.R.L SMITH 65 MM N°2 PR RHINOLOGIE
S095859 SMITH ENT SPECULA 65 MM N°2 FOR RHINOLOGY

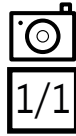

S095858
65 MM N°1

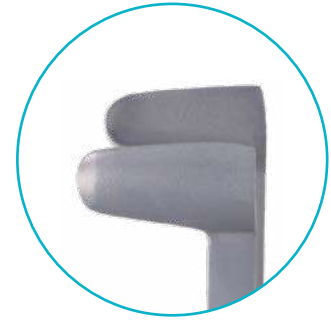

S095859
65 MM N°2



S095860
65 MM N°3



S095861
65 MM N°4

SPECULUM O.R.L VACHER ADULTE PR RHINOLOGIE
S095863 VACHER ENT SPECULA ADULT FOR RHINOLOGY

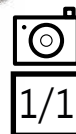

S095864
ENFANT
CHILDREN

S095865
NOURISSON
BABY

SPECULUM TRANSPHENOIDALE

www.in-surg.fr

S

TRANSPHENOIDAL SPECULA

SPECULUM TRANSPHENOIDALE 15 x 90 MM

S105870 *TRANSPHENOIDAL SPECULA 15 X 90 MM*



S105869
15 X 70 MM

S105871
15 X 110 MM

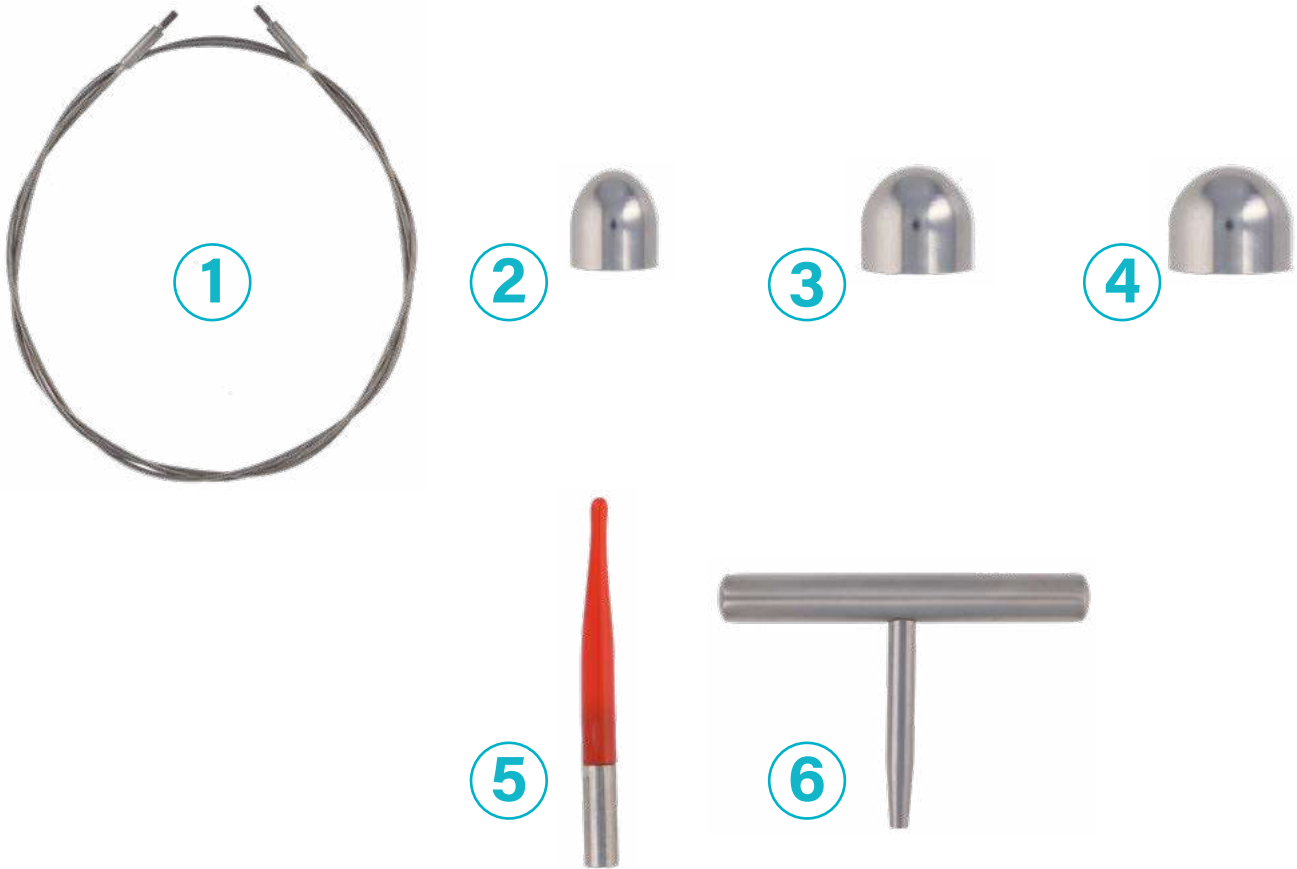
STRIPPER VEINEUX NABATOFF
NABATOFF VENOUS STRIPPER

- | | | | |
|----------|----------------|---|--|
| 1 | S115875 | CABLE PR STRIPPER VEINEUX NABATOFF 900 MM L'UNITE | <i>CABLE FOR NABATOFF VENOUS STRIPPER 900 MM UNIT</i> |
| 2 | S115876 | EMBOUT OLIVE PR STRIPPER VEINEUX NABATOFF DIAM 6 MM L'UNITE | <i>OLIVE NOZZLE FOR NABATOFF VENOUS STRIPPER DIAM 6 MM UNIT</i> |
| 3 | S115877 | EMBOUT OLIVE PR STRIPPER VEINEUX NABATOFF DIAM 9 MM L'UNITE | <i>OLIVE NOZZLE FOR NABATOFF VENOUS STRIPPER DIAM 9 MM UNIT</i> |
| 4 | S115878 | EMBOUT OLIVE PR STRIPPER VEINEUX NABATOFF DIAM 12 MM L'UNITE | <i>OLIVE NOZZLE FOR NABATOFF VENOUS STRIPPER DIAM 12 MM UNIT</i> |
| 5 | S115879 | EMBOUT SILICONE PR STRIPPER VEINEUX NABATOFF L'UNITE | <i>SILICON NOZZLE FOR NABATOFF VENOUS STRIPPER UNIT</i> |
| 6 | S115880 | POIGNEE SEULE POUR STRIPPER VEINEUX NABATOFF | <i>HANDLE ONLY FOR NABATOFF VENOUS STRIPPER</i> |

STYLET

www.in-surg.fr

S

STYLUS

STYLET 140 MM BOUTONNE AVEC CHAS

S125881 *STYLUS 140 MM BUTTONED WITH EYE*

STYLET 250 MM BOUTONNE AVEC CHAS POINTU

S125894 *STYLUS 250 MM SHARP BUTTONED WITH EYE*



S125882
160 MM

S125883
200 MM

S125884
250 MM

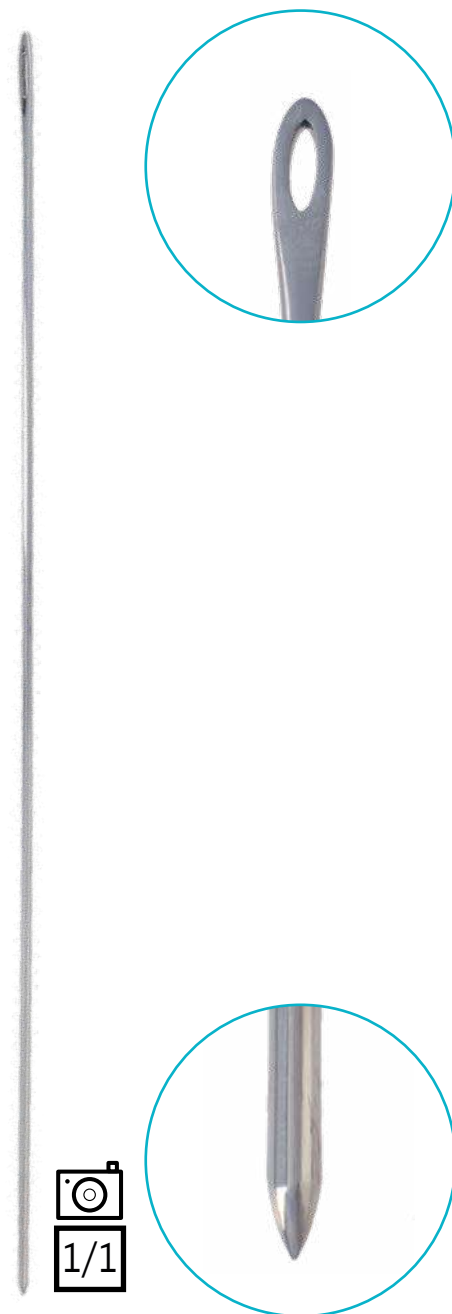

STYLET

STYLUS

STYLET 140 MM BOUTONNE DOUBLE
S125885 *STYLUS 140 MM BUTTONED DOUBLE*

STYLET DIAM 1,5 x 200 MM BOUTONNE DOUBLE
S125887 *STYLUS DIAM 1,5 X 200 MM BUTTONED DOUBLE*

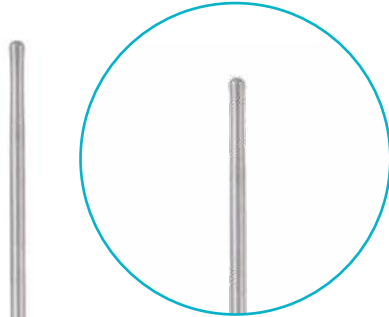

S125886
 200 MM

S125888
 250 MM

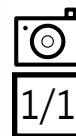
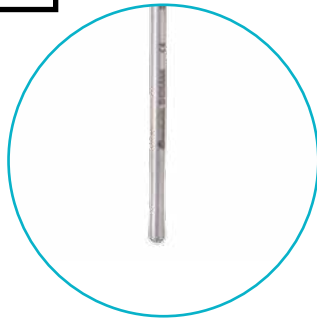
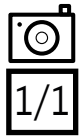

STYLET 140 MM POINTU BOUTONNE
S125889 *STYLUS 140 MM SHARP BUTTONED*

STYLET PROPHIL 140 MM BOUTONNE
S125892 *PROPHIL STYLUS 140 MM BUTTONED*



S125890
200 MM

S125891
250 MM

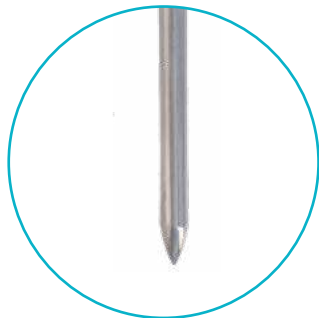
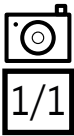

S125893
180 MM



NOTRE PARTENAIRE

Depuis 1945 à Milan, la société CBM s'est spécialisée dans le secteur de la stérilisation, en réalisant des paniers et calages de haute qualité et de grande fiabilité.

Paniers en tôle perforée garanties à vie.

La certification du système qualité qu'elle a obtenu depuis 1995 confirme la qualité de sa production.

Normes EN ISO 13485:2016



BASKET AND CUSHIONING



(FRA)

Les paniers en tôle perforée en acier AISI304 inoxydable représentent une évolution dans notre gamme de paniers en inox. Grâce à un processus de production flexible, nous sommes en mesure de réaliser une vaste gamme de dimensions aussi bien que de modèles personnalisés pour répondre aux exigences de nos clients. L'emploi de tôle en acier inoxydable assure une grande solidité et fiabilité.

Les paniers en tôle perforée permettent la pénétration de la vapeur et des détergents de nettoyage, en empêchant tout déplacement du matériel sur les côtés.

Tous les paniers sont pourvus de deux grandes poignées escamotables pour l'entretien du matériel. Le pied, en acier inoxydable, assure un empilement sûr et une meilleure robustesse.



Standard Basket and lid

Panier et couvercle standard



(ENG) Standard sizes to use in containers

(FRA) Dimensions standards à utiliser dans les conteneurs

	ART. IN'SURG / CBM	L	I	h	
 1 STU	Basket — Panier	S130046 - 75G	540	240	190
		S130047 - 75G/A	540	240	130
		S130048 - 75G	540	240	120
		S130049 - 75G	540	240	80
		S130050 - 75G	540	240	70
		S130251 - 75H	540	240	50
		S130252 - 75	540	240	45
		S130253 - 75M	540	240	41
Lid — Couvercle	S130252 - 75LIC	540	240		
Double handle — Double poignée					
Lid — Couvercle	S130264 - 75LIC-P	540	240		
Flat with handle — Plat avec poignée					

	ART. IN'SURG / CBM	L	I	h	
 1 STU	Basket — Panier	S130265 - 74G	480	240	150
		S130266 - 74G	480	240	90
		S130267 - 74G	480	240	70
		S130268 - 74H	480	240	50
		S130269 - 74	480	240	45
		S130270 - 74H	480	240	41
	Lid — Couvercle	S130277 - 74LIC	480	240	
Lid — Couvercle	S130278 - 74LIC-P	480	240		
Flat with handle — Plat avec poignée					



Standard Basket
= Panier standard



34 STU

	ART. IN'SURG - CBM	L	l	h
Basket — Panier	S130279 - 736V	400	240	180
	S130280 - 736V	400	240	120
	S130281 - 736V	400	240	90
	S130282 - 732V	400	240	70
	S130283 - 731V	400	240	50
	S130284 - 73V	400	240	45
	S130285 - 734V	400	240	41
Lid — Couvercle	S130293 - 73LIDV	400	240	



34 STU

	ART. IN'SURG - CBM	L	l	h
Basket — Panier	S130294 - 736	380	240	180
	S130295 - 735	380	240	120
	S130296 - 733	380	240	90
	S130297 - 732	380	240	70
	S130298 - 731	380	240	50
	S130299 - 73	380	240	45
	S130300 - 734	380	240	41
Coperchio — Tapa	S130308 - 73LID	380	240	
Lid — Couvercle	S130309 - 73LID-P	380	240	
Flat with handle — Plat avec poignée				



34 STU

	ART. IN'SURG - CBM	L	l	h
Basket — Panier	S130310 - 68/5	340	240	150
	S130311 - 68	340	240	70
	S130312 - 68/1	340	240	50
Lid — Couvercle	S130316 - 68LID	340	240	

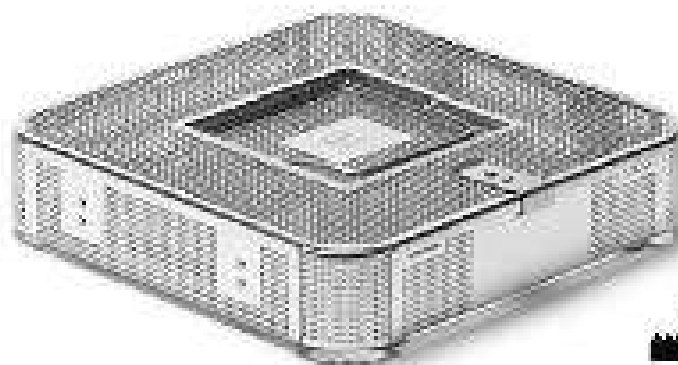

Basket — Panier
Lid — Couvre-b



3/4 STU

	ART. IN'SURG - COM	L	l	h
Basket — Panier	S130317 - 72x2	300	240	70
	S130318 - 72	300	240	50
	S130319 - 72HP	300	240	35
*Without handle — *Sans poignée				
Lid — Couvre-b	S130323 - 72LID	300	240	
Lid — Couvre-b	S130324 - 72LID-P	300	240	
Flat with handle — Plat avec poignée				



1/2 STU

	ART. IN'SURG - COM	L	l	h
Basket — Panier	S130325 - 71x2	240	240	30
	S130325 - 71x2	240	240	70
	S130327 - 71P	240	240	50
	S130328 - 71	240	240	45
	S130329 - 71x4	240	240	41
	S130330 - 71x8*	240	240	30**
*Without foot, without handles — *Sans pied, sans poignées				
Lid — Couvre-b	S130335 - 71LID	240	240	
Lid — Couvre-b	S130336 - 71LID-P*	240	240	
*Flat with handle — Plat avec poignée				
**Flat without handle, with holes for hand crossing. *Flat sans poignée, avec trous de passage pour les mains				

(ENG) Feet: Cotton in thermoset plastic.
Add the letter P to the article code in order to have 4 plastic feet that raise the basket: height of about 7 mm.

(FRA) Options: pieds en plastique thermosable.
Ajouter au code la lettre P pour avoir 4 pieds en plastique qui soulèvent le panier de 7 mm environ.





Basket — Panier



Lid — Couverture

(ENG) Standard sizes to use in minicontainers



(FRA) Dimensions standards à utiliser dans les miniconteneurs



For Mini container — Pour Mini conteneur 265x170 mm



	ART. INSURG - CBM	L	l	h
Basket — Panier	S130338 - 70	210	145	50
Lid — Couverture	S130340 - 70LID	210	145	

For Mini container — Pour Mini conteneur 265x185 mm



	ART. INSURG - CBM	L	l	h
Basket — Panier	S130341 - 77BT1	270	170	35
Without support, without handle Sans pied, sans poignée	S130342 - 77BT2	270	170	65
	S130343 - 77BT3	270	170	105
Lid — Couverture	S130344 - 77B TLID	270	170	

For Mini container — Pour Mini conteneur 300x130 mm



	ART. INSURG - CBM	L	l	h
Basket — Panier	S130345 - 76H	280	110	70
Without handle Sans poignée	S130346 - 76	280	110	40
Lid — Couverture	S130349 - 76LID	280	110	

(ENK) Spécia type and dimensions

(FRA) Mesure et dimensions spéciales



Basket — Panier

H — Coussin

ART. IN'SURG - ENK	L	l	h
S'30676 - 791M	600	290	80
S'30677 - 791MLD	600	290	

Basket — Panier

LK — Coussin

ART. IN'SURG - ENK	L	l	h
S'30678 - 792	600	290	140
S'30681 - 792LID	600	290	

Basket — Panier

H — Coussin

ART. IN'SURG - ENK	L	l	h
S'30683 - 795	650	240	160
S'30684 - 795	650	240	150
S'30685 - 793	650	240	80
S'30688 - 792	650	240	70
S'30682 - 791D	600	210	

Basket — Panier

LK — Coussin

ART. IN'SURG - ENK	L	l	h
S'30683 - 842	580	280	70
S'30685 - 842L	580	280	



IN SURG

Russe: Парик

Fin: Canada

Милл. Канада — Парик

ART. IN SURG - COM	L	I	R
S'2038 - 750	570	290	125
S'2040 - 75010	590	290	

Russe: Парик

Fin: Canada

ART. IN SURG - COM	L	I	R
S'2046 - 85	530	250	90
S'2047 - 851	530	250	90
S'2048 - 8510	530	250	

Russe: Парик

Fin: Canada

ART. IN SURG - COM	L	I	R
S'2041 - 700	440	240	70
S'2042 - 75	440	240	160
S'2043 - 701	440	240	70
S'2047 - 7910	440	240	

	ART. INSURG - CBM	L	l	h
Basket — Panier	S130427 - 76Z0	267	125	90
	S130428 - 76Z1	267	125	70
	S130429 - 76Z	267	125	40
Lid — Couverture	S130433 - 76ZLID	267	125	

(ENG) Feet Option in thermostable plastic. Add the letter F to the article code in order to have 4 plastic feet that raise the basket height of about 7 mm.

(FRA) Option pieds en plastique thermostable. Ajouter au code la lettre F pour avoir 4 pieds en plastique qui soulèvent le panier de 7 mm environ.



(ENG) Special products for washing process

(FRA) Produits spéciaux pour les phases de lavage

	ART. INSURG - CBM	L	l	h
Basket — Panier	S130434 - 74/1SL	470	240	50
	S130435 - 74/2SL	470	240	60
	S130436 - 74 AV	450	224	55
	S130427 - 71/2SL	260	200	60
	S130430 - 71/1SL	260	200	50

Entirely perforated 4x4 — entièrement perforé 4x4

Mini

Perforated metal baskets of Mini and Micro range are used to transport small medical devices for wash, wrap and sterilize. Mini baskets have a 2x2 side perforation to avoid any sorts of sharp tips, while the perforation of bottom and side allows quick drainage. Micro baskets are entirely 2x2 perforated to hold very small devices. Both of them have smooth surfaces for easy post-wrapping.



Mini

Lot/haute — Hauteur/couleur de



IN-SURG

Micro

Les corbeilles en métal perforées de la gamme Micro sont utilisées pour le transport de petits dispositifs médicaux à nettoyer, contrôler et stériliser. Les perforés Mini présentent une perforation latérale 2x2 pour empêcher le sort de crochets pointus, tandis que le bas et les cotés du fond et des côtés permettent la drainage rapide des liquides. Les corbeilles Micro sont entièrement perforées 2x2 pour contenir les dispositifs très petits. Les deux modèles ont des surfaces lisses pour faciliter les opérations en papier.

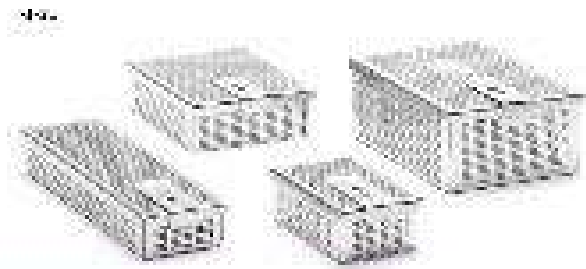

Micro

ART. IN-SURG - CM	L	l	H
S180441 - 78E	290	110	40
S180446 - 78F	297	125	40
S180448 - 77M	270	170	35
S180447 - 63M	220	50	30
S180448 - 63L	200	50	35
S180449 - 63L-F	170	100	25
S180450 - 63F	170	50	30
S180451 - 63M	130	40	25
S180452 - 48F	110	40	30
S180453 - 65F	90	30	30
S180454 - 67EM	135	170	35
S180456 - 63 L-F	90	50	30
S180458 - 62F	30	30	30

Micro

Lot/haute — Hauteur/couleur de

ART. IN-SURG - CM	L	l	H
S180470 - 71MF2	240	240	50
S180471 - 65MF2	320	170	55
S180472 - 77F2	270	170	35
S180473 - 79F2	210	145	50
S180474 - 67F2	170	155	35



Basket and lid – Panier et Couverture

(ENG) Standard sizes



(FRA) Dimensions standards

1 DIN

	ART. INSURG - CEM	L	l	h
Basket — Panier	S130490 - 745R	490	250	150
	S130491 - 741R	490	250	100
	S130492 - 748R	490	250	80
	S130493 - 74R	490	250	60
	S130494 - 74GR	490	250	50
Lid — Couverture	S130600 - 74RLID/C	490	250	
Lid — Couverture	S130601 - 74RLID/CH	490	250	

Flat without handle, with holes for hand crossing
 Plat sans poignée, avec trous de passage pour les mains

1/2 DIN

	ART. INSURG - CEM	L	l	h
Basket — Panier	S130602 - 71R	240	250	60
	S130603 - 71GR	240	250	100
Lid — Couverture	S130606 - 71RLID/C	240	250	

1/4 DIN

	ART. INSURG - CEM	L	l	h
Basket — Panier	S130607 - 69GR	120	250	140
Without handle — Sans poignée	S130608 - 69GR	120	250	80
	S130609 - 69R	120	250	60
	S130610 - 691R	120	250	40
Lid — Couverture	S130615 - 69RLID/C	120	250	



Basket — Panier

(ENG) Special sizes

(FRA) Dimensions spéciales

	ART. INSURG - CBM	L	l	h
Basket — Panier	S130156 - 79C	700	300	80
	S130517 - 79M	700	300	60



Lid — Couverts

	ART. INSURG - CBM	L	l	h
Basket — Panier	S130520 - 54BR	600	310	60
Lid — Couverts	S130522 - 54BR/LID	600	310	

Basket System

Wire mesh baskets — Paniers grillagés



(ENG)

The traditional series of mesh baskets allows instruments handling during washing and sterilizing phases as well as during use. Along with the series of DIN sizes, GBM produces other sizes that can meet the needs of sterilizing centres.

	ART. IN'SURG - GBM	L	l	h
Basket — Panier	S130533 - 87	540	240	90
	S130534 - 90	540	240	70
	S130535 - 86	540	240	50

	ART. IN'SURG - GBM	L	l	h
Basket — Panier 1 DIN	S130536 - 84/2	480	240	90
	S130537 - 84/1	480	240	70
	S130538 - 84	480	240	50

(FRA)

La série traditionnelle de paniers grillagés permet la manipulation des instruments pendant les différentes phases de nettoyage, stérilisation et usage. À la série de dimensions DIN, GBM associe autres dimensions pour répondre aux exigences des centrales de stérilisation.

	ART. IN'SURG - GBM	L	l	h
Basket — Panier	S130539 - 89	300	240	50

	ART. IN'SURG - GBM	L	l	h
Basket — Panier 1/2 DIN	S130540 - 85/2	240	240	90
	S130541 - 85/1	240	240	70
	S130542 - 85	240	240	50

	ART. IN'SURG - GBM	L	l	h
Basket — Panier	S130543 - 88	210	145	50



Basket and lid — Panier et Couverture



	ART. IN'SURG - CBM	L.	l.	h.
Basket — Panier	S130523 - 66/2R	360	250	60

	ART. IN'SURG - CBM	L.	l.	h.
Basket — Panier	68R	320	230	60
Lid — Couverture	68RLID/C	320	230	



	ART. IN'SURG	CFW	Long		It.
1	S130001	S0064030001	1x03-5	38	20
2	S130002	S0064030002	2x03-4	75	20
3	S130003	S0654030003	5x03-5	85	20
4	S130004	S0724030004	3x03-4	70	20
5	S130005	S0724030005	4x03-4	70	20
6	S130006	S0724030006	6x03-5	70	20
7	S130007	S0934030007	8x03-5	88	20
8	S130008	S0934030008	6x03-5	85	20
9	S130009	S1034030009	7x03-5	100	20
10	S130010	S1164030010	8x03-5	116	20

S130 28 - 0000 Spare screws 10 pcs
S130 28 - 0000 Screws 10 pcs

Full support in cup is with 2 screws - Cleopatra supplied from 1 cup 20 pcs



1- S130001



2- S130002



3- S130003



4- S130004



5- S130005



6- S130006



7- S130007



8- S130008



9- S130009



10- S130010

Small size — Height 80016



	ART. VS SURG - DEN	N.°	L.	P.
11	S130011 - S172400910	8 x 20+5	165	20
12	S130012 - S172400910	10 x 20+5	173	20
13	S130013 - S172400910	10 x 20+5	179	50
14	S130014 - S175400912	12 x 20+5	179	20
15	S130015 - S265400910	13 x 20+5	232	20
16	S130016 - S265400910	13 x 20+5	232	50
17	S130017 - S265400910	18 x 20+5	232	20

S130125 - D336 Spine screws 10 pcs
Vis de rechange 10 pcs

Each support is supplied with 2 screws - Chaque support est fourni avec 2 vis



11 - S130011



12 - S130012

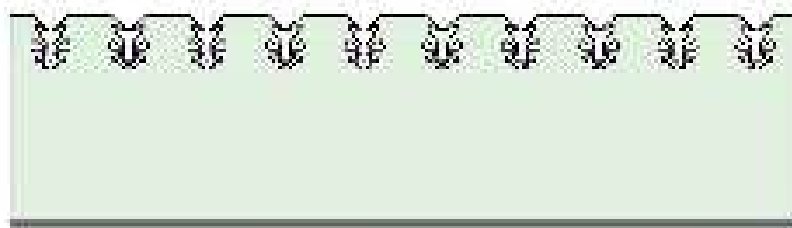

13 - S130013



14 - S130014



15 - S130015

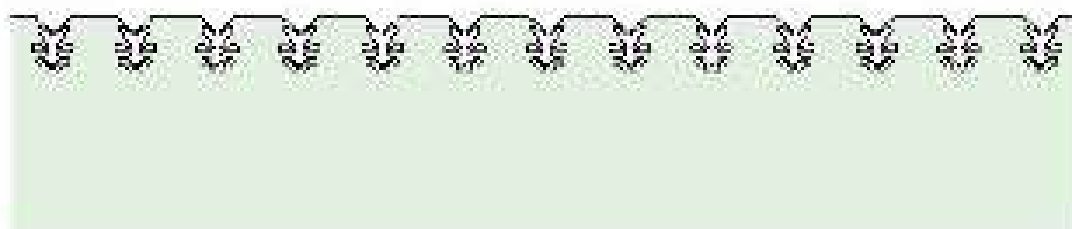

16 - S130016



17 - S130017



	ART. IN'SURG - CBM	N x Ø	l	h
1	S130017 - S03BAC030801	1 x Ø3+8	38	20
2	S130018 - S03BAC030802	2 x Ø3+8	38	20
3	S130019 - S072AC030803	3 x Ø3+8	72	20
4	S130020 - S072AC030804	4 x Ø3+8	72	20
5	S130021 - S072AC030806	6 x Ø3+8	72	20
6	S130022 - S178AC030810	10 x Ø3+8	178	20
7	S130023 - S232AC030813	13 x Ø3+8	232	20

S130128 - B966 Spare screws 10 pcs
Vis de rechange 10 pc

Each support is supplied with 2 screws - Chaque support est fourni avec 2 vis



1 - S130017



2 - S130018



3 - S130019



4 - S130020



5 - S130021



6 - S130022



7 - S130023



1 - S130024



2 - S130025



3 - S130026



4 - S130027

	ART. INSURG - CBM	N x Ø	l	h
1	S130024 - S038A081501	1 x Ø8+15	38	30
2	S130025 - S072A081503	3 x Ø8+15	72	30
3	S130026 - S178A081508	8 x Ø8+15	178	30
4	S130027 - S178A071008	8 x Ø7+10	178	30
S130128 - B686		Spare screws 10 pcs Vis de rechange 10 pc		

Each support is supplied with 2 screws - Chaque support est fourni avec 2 vis



Comb — Peigne

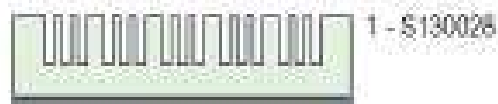

1 - S130028

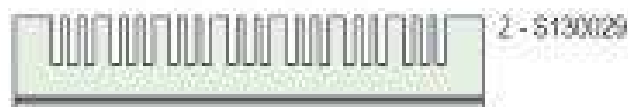

2 - S130029



3 - S130030



4 - S130131

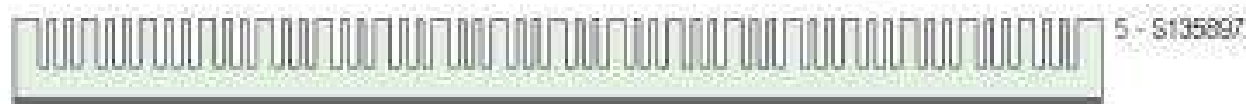

5 - S135897

	ART. INSURG - CBM	N	l	h
1	S130028 - S072P020305	5	72	20
2	S130029 - S100P020307	7	100	20
3	S130030 - S165P020313	13	165	20
4	S130131 - S178P020314	14	178	20
5	S135897 - S232P020318	18	232	20
S130128 - B668		Spare screws 10 pcs Vis de rechange 10 pc		

Each support is supplied with 2 screws - Chaque support est fourni avec 2 vis



	ART IN'SURG - CBM	NxØ	L	h
1	S130032 - S100TC030507	7 x Ø3+5	100	20
2	S130033 - S232TC030518	18 x Ø3+5	232	20
3	S130034 - S118R030905	5 x Ø3+9	118	30
4	S130035 - S185R030907	7 x Ø3+9	185	30
5	S130036 - S232R030911	11 x Ø3+9	232	30
6	S130037 - S185TH030714	14 x Ø3+7	185	40
7	S130038 - S232TH030720	20 x Ø3+7	232	40

S130128 - B668

Spare screws 10 pcs
Vis de rechange 10 pc

Each support is supplied with 2 screws - Chaque support est fourni avec 2 vis

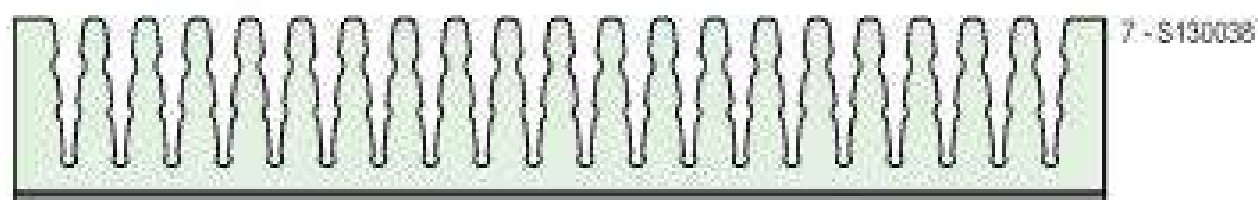
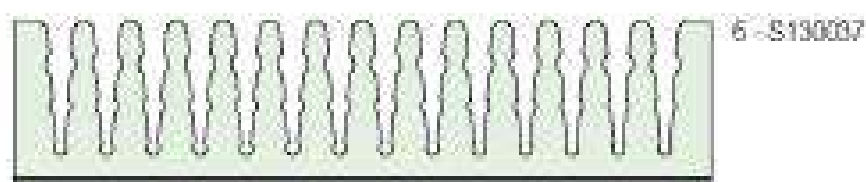
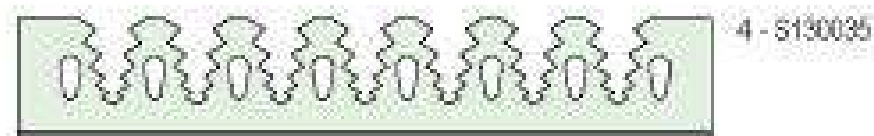
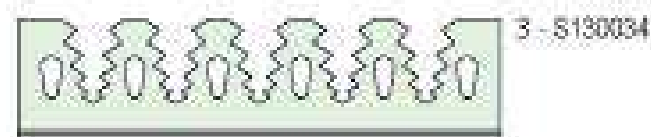



1 - S130039



2 - S130040



3 - S130041



4 - S130042



5 - S130043



6 - S130044



7 - S130045



8 - S130046



9 - S130047

	ART. INSURG - CBM	N.º	L	h
1	S130039 - S072FC3NN05	5 x Ø3	72	20
2	S130040 - M072FC3NN06	6 x Ø3	72	20
3	S130041 - S072FC5NN05	5 x Ø5	72	20
4	S130042 - S072FC6NN05	5 x Ø6	72	20
5	S130043 - S178FC3NN12	12 x Ø3	178	20
6	S130044 - S178FC6NN12	12 x Ø5	178	20
7	S130045 - S232AL080515	4 x Ø8 8 x Ø6 3 x Ø5	232	20
8	S130046 - S232AL08NN10	10 x Ø8	232	20
9	S130047 - S232MIS0319	19 x Ø3	232	20

S130128 - B666

Spare screws 10 pcs
Vis de rechange 10 pc

Each support is supplied with 2 screws

Chaque support est fourni avec 2 vis



Stal multiple — Stal multiple



	ART. IN'SURG - CBM	NxØ	l	h
1	S130048 - S070U070605	5 x Ø7+9	70	28
2	S130049 - S140U070910	10 x Ø7+9	140	28
	S130128 - B666	Spare screws 10 pcs Vis de rechange 10 pc.		

Each support is supplied with 2 screws - Chaque support est fourni avec 2 vis

Waves — Ondes



	ART. IN'SURG - CBM	N	L	h
1	S130050 - S072WAVES	5	72	17
2	S130051 - S165WAVES	12	165	17
3	S130052 - S178WAVES	12	178	17
	S130128 - B668	Spare screws 10 pcs Vis de rechange 10 pc.		

Each support is supplied with 2 screws —
Chaque support est fourni avec 2 vis

Distal tendons holder — Peda progress dentaire



1 - S19003

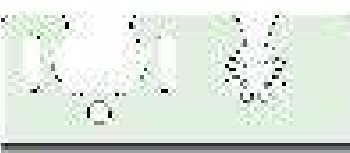

2 - S19005

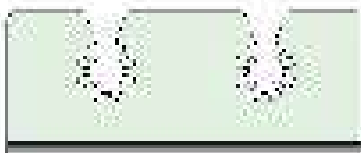

3 - S19015

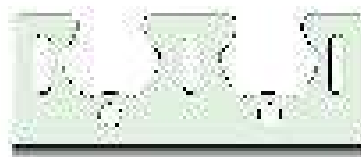

4 - S19008

	ART. IN.SURG. CRM	N° de	l	h
1	S19003 - 3038V016-201	1 x 21,5+0	36	27
2	S19005 - 3035V19-002	1 x 21,5+0	36	27
		1 x 20-8		
3	S190055 - 3035V03F0007	2 x 20-8	36	27
4	S19008 - 3035V0151-002	2 x 21,5+0	36	27
5	S19007 - S1-CDM1035003	2 x 21,5+0	100	27
		1 x 20-8		
6	S190053 - S1-CDV1500037	1 x 21,5+0	100	27
		2 x 20-8		

S190125 - R633

Scale: overall 10 pcs
 Pcs de recharge 10 pcs

Each support is supplied with 2 screws - Chaque support est fourni avec 2 vis



5 - S190167

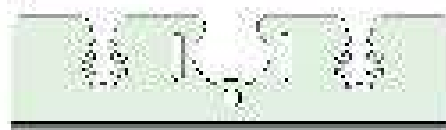

6 - S190053

Legar — Legar



1 - S19009



2 - S19003

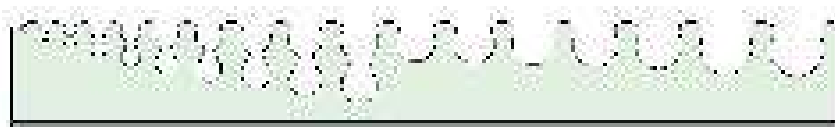

3 - S19007



	ART. IN.SURG. CRM	N° de	l	h
1	S19009 - S1-40-0010017	17 x 21,5	149	20
2	S19003 - S1-40-0091403	9 x 29+14	149	29
3	S19007 - S232-015020	27 x 21-11	132	30

S190125 - R633

Scale: overall 10 pcs
 Pcs de recharge 10 pcs

Each support is supplied with 2 screws - Chaque support est fourni avec 2 vis

Specials — Spéciaux



1 - S130065



IN'SURG



2 - S130066



3 - S130067

	ART. IN'SURG - CBM	N x Ø	l	h
1	S130065 - S050FIBRA	1 x laser fiber 1 x fibre laser	50	20
2	S130066 - S165MIXS TR6	2 x Ø8-15 6 x Ø3-8	165	25
3	S130067 - S178MIXS TR6	2 x Ø8-15 6 x Ø3-8	178	38

S130128 - B666 Spare screws 10 pcs
Vis de rechange 10 pc.

Each support is supplied with 2 screws - Chaque support est fourni avec 2 vis



ART. IN'SURG - CBM

Tax 20

S130068 - STORX

Screwdriver - Tournevis

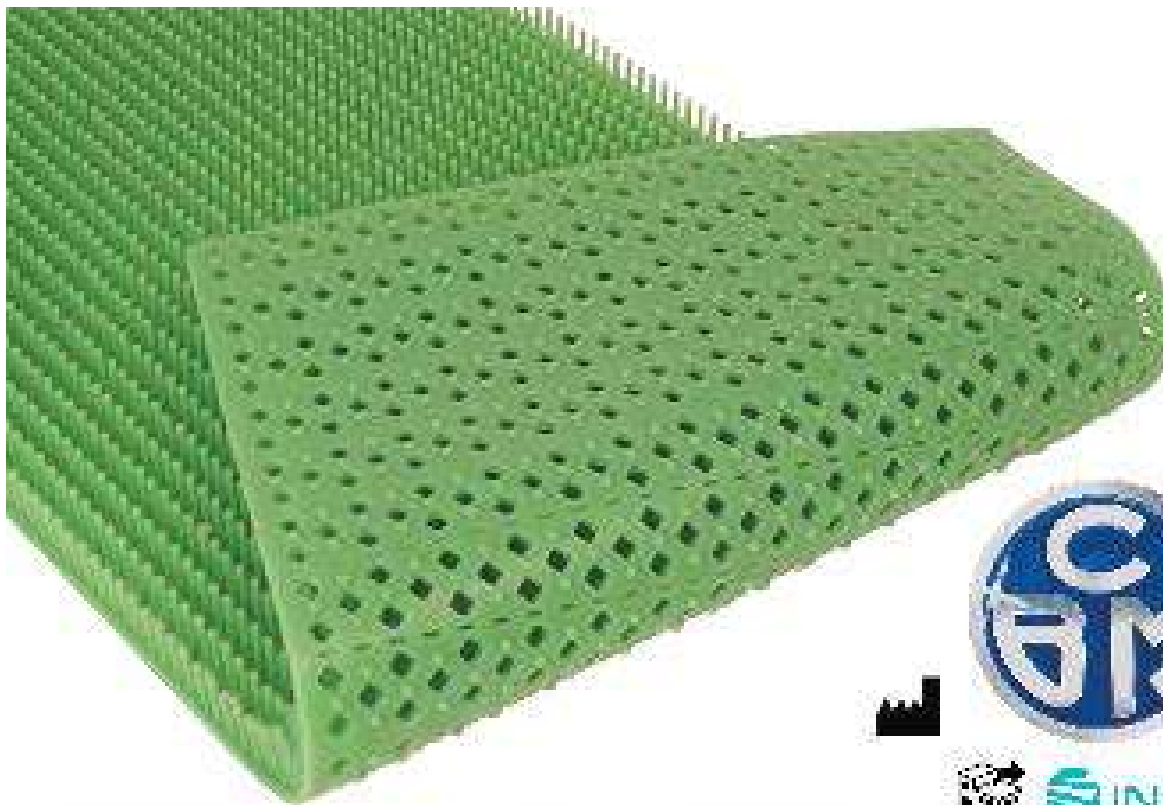

ART. IN'SURG - GAM	L	I	Boîte! - Paquet	Conteneur - Conteneur
S130069 - 2000607L	620	230	510x240	1 STU
S130070 - 2000616L	460	220	490x240	
S120071 - 2000622L	460	140	490x150	
S130072 - 20006082L	400	220		5x1 STU
S130073 - 2000608L	380	230	400x240	
S130074 - 2000618L	380	110	400x120	
S130075 - 20006081L	360	220	390x240	
S120076 - 2000624L	320	140	350x150	
S130077 - 2000614L	320	230	340x240	
S120078 - 2000617L	280	220	300x240	
S120079 - 20006071L	260	120		Min 200x130
S120080 - 2000605L	260	220		1/2 STU
S130081 - 2000611L	260	160	270x170	Min 285x185
S120082 - 2000607L	260	90	290x110	
S130083 - 2000603L	220	220	240x240	
S120084 - 2000609L	220	160		Min 285x170
S130085 - 2000606L	195	135	210x145	
S130086 - 2000625L	190	165	200x170	
S120087 - 2000612L	165	130	170x135	
S130088 - 2000610L	165	45	170x50	
S130089 - 20006091L	220	80		
S130090 - 20006171L	220	140		
S120091 - 2000627L	60	60		
S130092 - 2000628L	240	220		
S130093 - 2000629L	260	140		

Easy Fit System

(ENG)

Soft lips can be mounted on the lid of a basket. Thanks to its design Soft lips are suitable to retain instruments into perforated baskets equipped either with Fleximat or Easy Fit.

(FRA)

Les barrettes amovibles en silicone peuvent être installées sur le couvercle du panier. Grâce à leur design elles sont parfaites pour maintenir immobiles les instruments à l'intérieur du panier équipé par le tapis Fleximat ou par le système Easy Fit.

Silicone Soft Lips

Barrettes en silicone Soft Lips



ART. IN'SURG - CBM	L
S130094 - 73S200	360
S135898 - 71S200	220
S130095 - 643CR201	130
S130098 - 76S200	90

(ENG)

Pins are useful for positioning ring-handle surgical instruments. Pins are also used, together with dividers, to create separated compartments into a basket.

(FRA)

Les attaches de fixation sont utiles pour les positionnement des instruments avec empoignement à anneau. Ils sont aussi utilisés, avec les séparateurs, pour créer des compartiments séparés, à l'intérieur du panier.

Stainless steel pins for instruments

Attache de fixation en acier inox pour instruments



ART. IN'SURG - CBM	h
S130097 - 2000/10/5R	20
S130098 - 2000/075	32
S130099 - 2000/20/5R	50

Screw fixing

Fixation à vis



Baskets for Hegar uterin dilaters

Panier pour dilataleur utérin Hegar

(ENG)

Perforated sheet baskets for Hegar holders are used for positioning and transport of Hegar. The fixed silicone lip positioned on the lid of the basket allows the fixing of the Hegar when the lid is closed, preventing their movement. The silicone supports are screwed to the body of the basket and they have growing sizes to lodge Hegars from the smallest up to biggest diameter.

(FRA)

Les paniers en tôle perforée avec porte-Hegar sont utilisés pour le positionnement et le transport de Hegar. La lamelle de silicone fixe positionnée sur le couvercle du panier permet la fixation de Hegars quand le couvercle est fermé, en empêchant tout mouvement. Les supports en silicone sont vissés au corps du panier et ils présentent des dimensions croissantes pour permettre la déposition de Hegar, de diamètre le plus petit au plus grande.

ART. INSURG - CBM	L.	l.	h.
S130105 - 79 HE011421	300	240	50

- Easy Fit supports for 27 dilators lined up
 - From Ø1 to Ø13.5 (every 0.5)
 - With lid and silicone Soft Lips
-
- Support Easy Fit pour 27 dilateurs en rang
 - De Ø1 à Ø13.5 (chaque 0.5)
 - Avec couvercle et bande en silicone Soft Lips



ART. INSURG - CBM	L.	l.	h.
S130106 - 71.1 HE011427	240	240	50
S130107 - 71.2 SPHE011427	240	240	45

- Easy Fit supports for 27 overlaying dilators
 - From Ø1 to Ø13.5 (every 0.5)
 - With lid and silicone Soft Lips
-
- Supports Easy Fit pour 27 dilateurs superposés
 - De Ø1 à Ø13.5 (chaque 0.5)
 - Avec couvercle et bande en silicone Soft Lips



Microsurgery baskets with silicone mat

Paniers avec tapis en silicone pour microchirurgie

(FNC)

Perforated steel basket for microsurgery are used for positioning delicate surgical instruments for microsurgery (ophthalmic, dentistry, etc.). They fit perfectly for every need and they are essential in disinfection, ultrasonic washing and steam sterilization processes. Thanks to the silicone mat positioned in the basket body and to both fixed soft lips arranged on the lid, instruments are perfectly blocked, avoiding any damage during handling.



(FRA)



Les paniers en tôle perforée pour microchirurgie sont utilisés pour le positionnement de délicats instruments chirurgicaux de microchirurgie (ophtalmologie, dentisterie, etc.). Ils s'adaptent parfaitement à tous les besoins et ils sont essentiels pour les procédés de désinfection, lavage à ultrasons et stérilisation à vapeur. Grâce au tapis en silicone positionné dans le corps du panier et aux barrettes en silicone fixés à l'intérieur du couvercle, les instruments sont parfaitement bloqués évitant tout endommagements lors de la manipulation.



ART. IN'SURG - CDM	L	L	h	Soft Lips
E 130108 - 714 TL	240	240	41	2 on the lid - 2 sur le couvercle
E 130109 - 734 TL	300	240	41	2 on the lid - 2 sur le couvercle
E 130110 - 744 TL	480	240	41	4 on the lid - 4 sur le couvercle

With hinged flat lid, with handle — Avec couvercle plat avec charnières et poignée

With silicone mat — Avec tapis en silicone



ART. IN'SURG - CDM	L	L	h
3130111 - 712-4MS	240	240	00

- With hinged flat lid, with handle
- With inner tray
- With 2 silicone mats and 2 soft lips for each level

- Avec couvercle plat avec charnières, avec poignée
- Avec plateau intérieur
- Avec 2 tapis en silicone et 2 barres en silicone pour chaque plateau

Microsurgery baskets with Easy Fit System

Paniers pour microchirurgie avec système Easy Fit



(ENG)

Microsurgery baskets with Easy Fit system are used for positioning surgical instruments for microsurgery. They are perfectly adapted to every need and safeguards the instruments during the disinfection, washing (ultrasound and/or thermal disinfection)

and sterilization processes. Thanks to the silicone supports positioned in the basket, instruments are perfectly fixed, avoiding any damage during handling. The lid further protects the instruments from accidental falls.



(FRA)

Les paniers pour microchirurgie avec système Easy Fit sont utilisés pour le positionnement des instruments chirurgicaux pour microchirurgie. Ils s'adaptent parfaitement à chaque besoin et protègent les instruments pendant les procédés de désinfection, lavage à ultrason et/ou thermique (désinfection) et stérilisation. Grâce aux supports en silicone positionnés dans le panier, les instruments sont fixés parfaitement, en évitant tout dommage lors de la manipulation. Le couvercle protège ultérieurement les instruments de chutes accidentelles.

ART. INSURG - CEM	L	l	h
S130112 - 71MICRO	240	240	45
S130113 - 73MICRO	260	240	45

With lid — Avec couvercle

2 supports — 2 supports	S135866 - S232A030818
1 support — 1 support	S130003 - S232T060518
1 support — 1 support	S135897 - S232P020318

See page 108-111 — Voir pag. 108-111



ART. INSURG - CEM	L	l	h	Supports ART. INSURG - CEM
S130114 - 77MICRO	270	170	35	2 x S135896 - S232A030818
S130115 - 77MICRO	270	170	35	1 x S135896 - S232A030818 1 x S135897 - S232P020318
S130116 - 77MICRO	200	170	35	1 x S130012 - S178A030810 1 x S130034 - S178P020314
S130117 - 77MICRO	200	170	35	2 x S130012 - S178A030810

With hinged lid, with handle, supports see page 108-110

Avec couvercle à charnière, avec poignée, supports voir page 108-110

Micro Dissector baskets

Paniers pour Micro Dissecteurs

(FR)

Micro Dissector baskets are used for positioning delicate neurosurgery instruments. Thanks to Easyfill supports and tilting system it is possible to put up to 19 micro instruments. When tilting system is in rest position, and basket lid is closed, micro instruments can be carried, washed and packed safely, avoiding any damage due to handling.

(FR)

Les paniers pour Micro Dissecteurs sont utilisés pour le placement délicat de tels instruments pour neurochirurgie. Grâce aux supports Easyfill et au système de basculement, il est possible de loger jusqu'à 19 micro instruments. Quand le système de basculement est en position de repos, et le couvercle est fermé, les micro instruments peuvent être transportés, lavés et emballés sans risque, en évitant quelconque type de dommage dû à la manipulation.

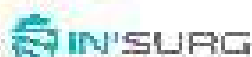

AR : IN'SURG - 08M	L	l	h
9130118 - 72ME	300	240	50



Baskets for laser optical fibre

Paniers pour fibres optiques laser

(ENG)

Baskets for laser optical fibre are used for positioning delicate and thin optical fibres for laser surgery. Thanks to Easyfit supports it is possible to hold the long laser fibre inside a single basket.

This solution let safely transporting and processing, avoiding any damage due to handling.

(FRA)

Les paniers pour fibres optiques laser sont utilisés pour le positionnement de délicates et très fines fibres optiques pour chirurgie à laser.

Grâce aux supports Easyfit il est possible de contenir la longue fibre optique pour chirurgie à laser.

Cette solution permet de transporter et utiliser en toute sécurité, en évitant quelconque type de dommage dû à la manipulation.



ART. IN'SURG - CBM	L	I	H
S130119 - 714FC	240	240	41

Kirschner wires dispenser — Distributeur des fils de Kirschner

(ENG)

Kirschner wires dispenser are suitable for transport, decontamination, washing and steam sterilization of the commonly used Kirschner wires. The distributors have smooth surfaces and they are completely free of sharp edges to ensure maximum safety during handling to avoid any possibility of breaking of soft packaging used for steam sterilization (paper, envelopes, etc.). The practical and safe interlocking closure system avoids any mixing of wires of different diameters. The dispenser has 2 silicone supports (slotted) positioned on the short side (one each side) to protect the tips of the Kirschner wires during handling. The wire support shows the indication of the positionable diameters with its size (hole) next alongside each usable slot. Each slot of the support can keep up to 10 wires per diameter.

(FRA)

Le distributeur des fils de Kirschner est approprié pour le transport, la décontamination, le lavage et la stérilisation à vapeur des broches de Kirschner.

Les distributeurs ont des surfaces lisses et ils sont sans bords tranchants afin d'assurer une sécurité maximale lors de la manipulation, cela élimine toute possibilité de rupture des emballages souples utilisés pour la stérilisation à vapeur (papier, enveloppes, etc.).

Le système de fermeture à verrouillage est pratique, sûr et évite le mélange des broches de diamètres différents. Il présente 2 supports en silicone (non toxique) positionnés sur les bords courts (un de chaque côté) pour protéger la pointe des broches de Kirschner pendant la manipulation.

Sur le support se trouve les stamillees pour chaque broche.

Le logement du support peut contenir jusqu'à 10 broches par diamètre.

Kirschner L 160 mm



IN'SURG



ART. IN'SURG - CDM	L	l	h
S130120 - 70x167-160A	200	150	45
Ø	0,8 - 1,0 - 1,2 - 1,4 - 1,5 - 1,7 - 1,8 - 2,0 - 2,5 - 3,0		
S130121 - 70x167-160B	200	150	45
Ø	1,0 - 1,2 - 1,4 - 1,5 - 1,6 - 1,8 - 2,0 - 2,5 - 3,0 - 3,5		
S130122 - 70x167-160C	200	150	45
Ø	1,0 - 1,4 - 1,5 - 1,6 - 1,8 - 2,0 - 2,2 - 2,5 - 3,0 - 3,5		



ART. IN'SURG - CDM	L	l	h
S130123 - 76x167-160A	200	60	50
Ø	1,0 - 2,0 - 2,5 - 3,0		
S130124 - 76x167-160B	200	60	50
Ø	1,0 - 1,2 - 1,4 - 1,6		
S130125 - 76x167-160C	200	60	50
Ø	1,0 - 2,0 - 2,5		

Kürschner L 310 mm



INSURG

ART. INSURG - CBM	L	l	h
S130126 - 72KWT310A	350	150	45
Ø	0,8 - 1,0 - 1,2 - 1,4 - 1,5 - 1,6 - 1,8 - 2,0 - 2,5 - 3,0		
S130127 - 72KWT310B	350	150	45
Ø	1,0 - 1,2 - 1,4 - 1,5 - 1,6 - 1,8 - 2,0 - 2,5 - 3,0 - 3,5		
S130128 - 72KWT310C	350	150	45
Ø	1,0 - 1,4 - 1,5 - 1,6 - 1,8 - 2,0 - 2,2 - 2,5 - 3,0 - 3,5		

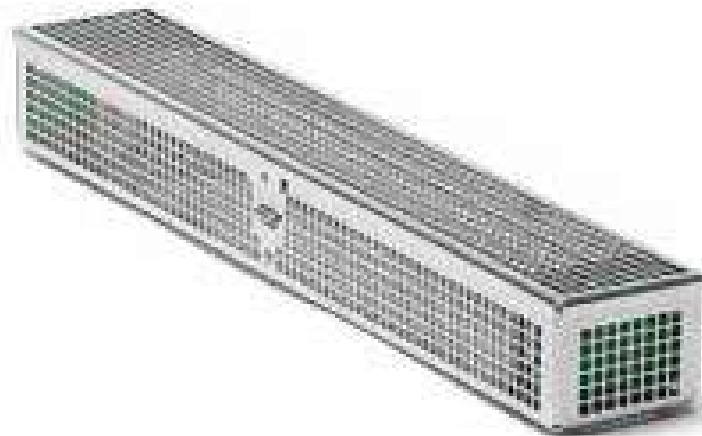

ART. INSURG - CBM	L	l	h
S130129 - 71KWT310A	350	60	50
Ø	1,5 - 2,0 - 2,5 - 3,0		
S130130 - 71KWT310B	350	60	50
Ø	1,0 - 1,2 - 1,4 - 1,6		
S130131 - 71KWT310C	350	60	50
Ø	1,8 - 2,0 - 2,2 - 2,5		

Baskets complete with lid and supports

Paniers complets de couvercle et supports

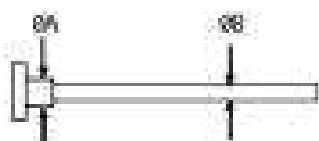

ART. IN'SURG - CBM	L	l	h	A	B
S130102 - 64/S	600	70	60	Ø15	Ø3-Ø
S130103 - 48/S	480	150	60	Ø15	Ø3-Ø
S130104 - 48/S1	480	150	80	Ø15	Ø9+15
S130105 - 48/SA	480	150	80	Ø12	Ø3-Ø
S130106 - 48/SA1	480	150	80	Ø12	Ø9+15
S130107 - 66/S	450	70	60	Ø15	Ø3-Ø
S130108 - 66/S1	450	70	60	Ø15	Ø8+15
S130109 - 66/SA	450	70	60	Ø12	Ø3-Ø
S130110 - 66/SA1	450	70	60	Ø12	Ø8+15
S130111 - 65/S	290	70	60	Ø15	Ø3-Ø
S130112 - 65/S1	290	70	60	Ø15	Ø9+15
S130113 - 65/SA	290	70	60	Ø12	Ø3-Ø
S130114 - 65/SA1	290	70	60	Ø12	Ø8+15
S130145 - 63/S	260	70	45	Ø15	Ø3-Ø

*Handle on the lid — Poignée sur le couvercle



Baskets complete with lid, without supports—
Paniers complets de couvercle, sans supports

ART. IN'SURG - CBM	L	l	h
S130146 - 64/SV	600	70	60
S130147 - 48/V*	480	150	80
S130148 - 66/V*	480	150	90
S130149 - 66/V	450	70	60
S130150 - 64/O*	400	120	45
S130151 - 64/V	400	70	45
S130152 - 66/2V*	350	150	45
S130153 - 65/V	290	70	60
S130154 - 63/V	260	70	45

Baskets for long optics without supports

Faniers pour longues optiques sans supports

(FNG)

Baskets for long optics are equipped with a tightening wire edge on top of the body and with a double closure and a handle on the lid.

(FRA)

Faniers pour longues optiques sont équipés sur le corps d'un fil supérieur de renforcement et d'une double fermeture et avec poignée sur le couvercle.

ART. INSURG - CBM	L	l	h.
S130156 - 79DCV	1100	120	80
S130158 - 79CV	900	150	90
S130157 - 79HV2	850	200	150
S130158 - 79HV	850	150	80
S130159 - 79HV1	850	120	90
S130130 - 98PANV	750	240	90
S130151 - 79BV	750	150	100
S130132 - 78AV	750	150	90
S130133 - 79DV8	700	325	100
S130154 - 78DV	700	265	100
S130135 - 79DV2	700	150	100
S130158 - 79DV1	700	100	100
S130157 - 64LDV	663	364	101
S130138 - 79DVE	650	240	70
S130139 - 79DVE3	650	175	70
S130170 - 64IECV	650	150	90
S130171 - 64ECV	650	150	70
S130172 - 64AV	600	150	100
S130173 - 64DV	600	150	70
S130174 - 645V	600	120	90
S130175 - 68AV	580	150	90

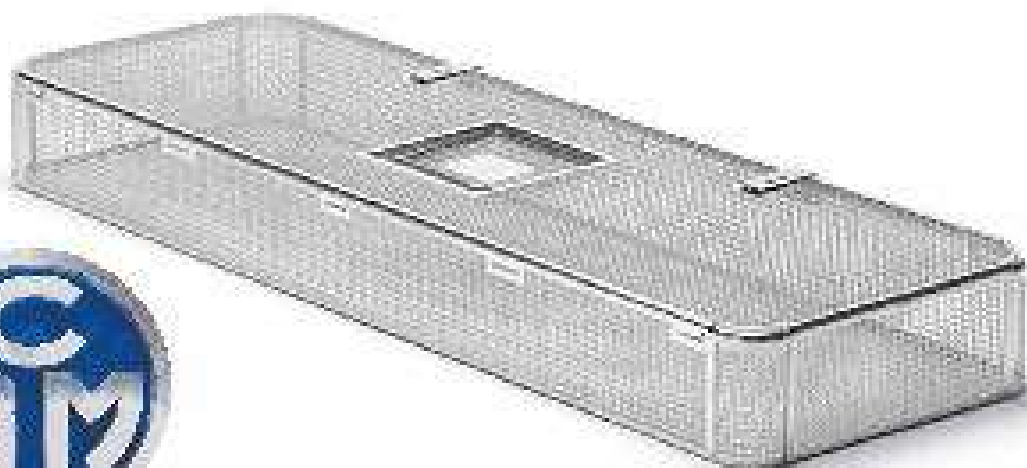

IN'SURG

Easy Fit supports for endoscopes —
Support Easy Fit pour endoscopes



	ART. IN'SURG - CBM	L	h	NxØ
1	S130176 - S038E25NND1	38	39	1 x Ø25
2	S130177 - S038E19NND1	38	30	1 x Ø19
3	S130178 - S038E15NND1	38	30	1 x Ø15
4	S130179 - S038DV12	38	45	1 x Ø12
5	S130180 - S038E12NND1	38	30	1 x Ø12
6	S130181 - S038E08NND1	38	30	1 x Ø8
7	S130182 - S038E3-6NND1	38	24	1 x Ø3-4
8	S130183 - S038E02SS01	38	56	1 x Ø2
9	S130184 - S038A081501	38	30	1 x Ø8-15
10	S130185 - S038A030801	38	20	1 x Ø3-8
11	S130186 - S038B04NND1	38	30	1 x Ø4
12	S130187 - S038B08NND1	38	30	1 x Ø8
13	S130188 - S038B08NND1	38	30	1 x Ø8
14	S130189 - S038B12NND1	38	30	1 x Ø12
15	S130190 - 66/S003	38	56	1 x Ø15
16	S130191 - 66/S012	38	56	1 x Ø12
17	S130192 - 66/S1004	38	54	1 x Ø8-15
18	S130193 - 66/S004	38	50	1 x Ø3-8
19	S130194 - 66/S019	38	56	1 x Ø19
20	S130195 - 66/SB04	38	55	1 x Ø4
21	S130196 - 66/SB06	38	55	1 x Ø6
22	S130197 - 66/SB08	38	55	1 x Ø8
23	S130198 - 66/SB12	38	55	1 x Ø12
24	S130199 - S050E27NND1	50	41	1 x Ø27
25	S130200 - S050E22NND1	50	41	1 x Ø22
26	S130201 - S050FEN001	50	45	1 x Ø20
27	S130202 - S072D120308	72	30	1 x A = Ø12 + 1 x Ø3-8
28	S130203 - S072D120815	72	30	1 x A = Ø12 + 1 x Ø8-15
29	S130204 - S072D150308	72	30	1 x A = Ø15 + 1 x Ø3-8
30	S130205 - S072D150815	72	30	1 x A = Ø15 + 1 x Ø8-15
31	S130206 - S072DV31L	72	45	1 x Ø31
32	S130207 - S072DV31H	72	28	
33	S130208 - S072DV43L	72	45	1 x Ø43
34	S130209 - S072DV43H	72	22	

S130128 - B666 Spare screws: 10 pcs
Vis de rechange: 10 pc.

Each support is supplied with 2 screws - Chaque support est fourni avec 2 vis

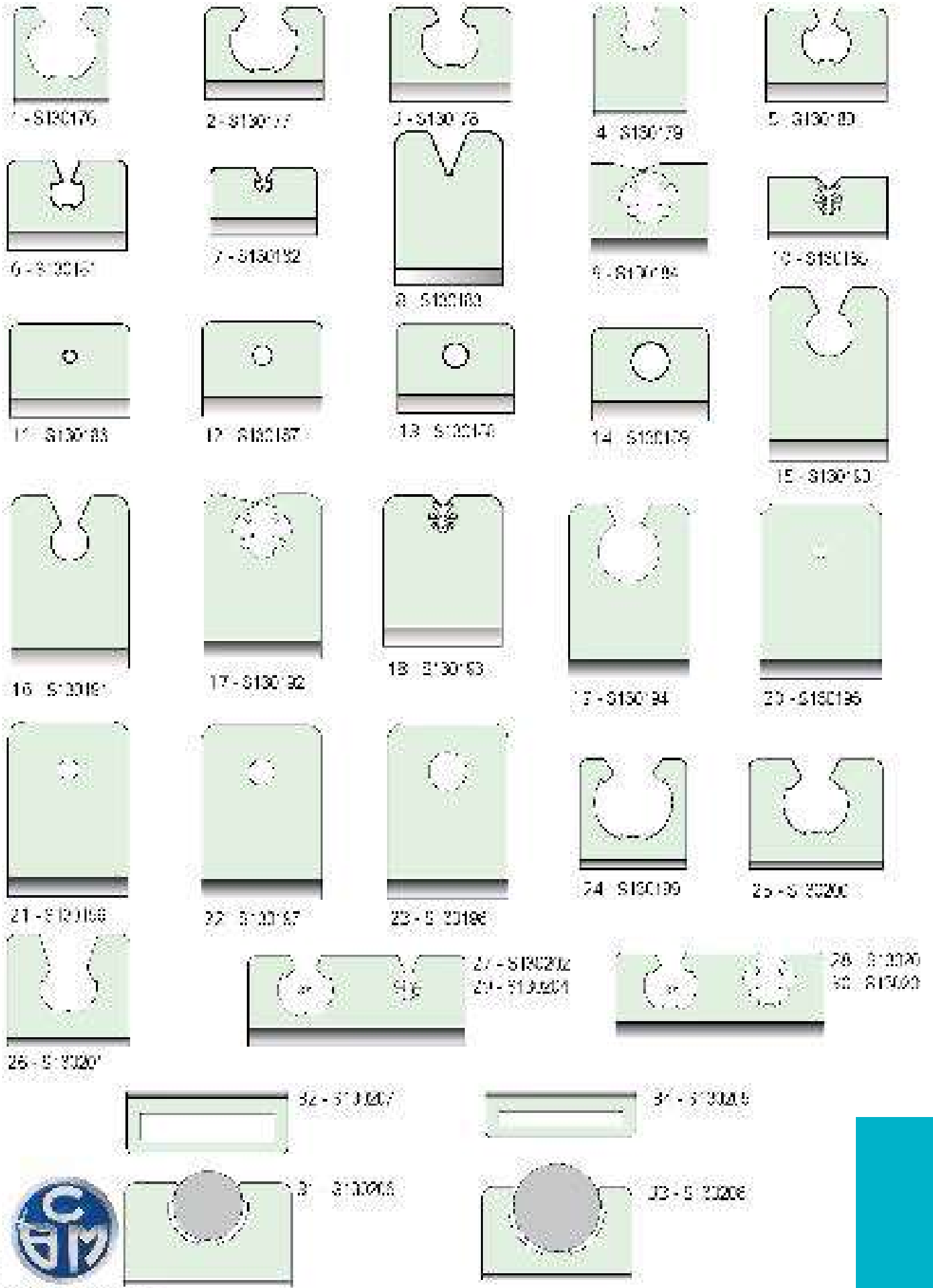

**PANIER ET CALAGE POUR
ROBOT DA VINCI**

*BASKET AND CUSHIONING
FOR DA VINCI ROBOT*

Baskets for new generation instruments

Paniers pour instruments de nouvelle génération



ART. IN'SURG - CBM	L.	l.	H.	N. of instruments — N. d'instruments
E120210 - 79DVXL-8	660	325	100	8 x Ø8
E120211 - 79DVXL	660	255	100	6 x Ø8
E120212 - 79DVXL/C	660	255	100	6 x Ø8 + supports and pins for Trocar* accessible positioning + supports et viselles pour l'épousonnement de Trocar* et câbles
E120213 - 79DVXL-2	660	150	100	2 x Ø8
E120214 - 79DVXL-1	660	100	100	1 x Ø8

(ENG)

They are equipped with 2 non toxic Poylit® silicone and stainless steel supports. Lid has 80ft-ps , double handle and locking clamping system.

(FRA)

Ils sont équipés de 2 supports Poylit® en silicone alimentaire et acier inoxydable. Le couvercle a des bords 80ft-ps en silicone, double poignée et fermement verrouillé.



Baskets for new generation 3D optic

Paniers pour optique 3D de nouvelle génération



ART INSURG	CBM	L	L	H	N. instruments — N. d'instruments
S120215 - 640500/XL	S83	383	354	101	1 x optique with cable and connector 1 x optique avec câble et connecteur

[ENG]

They are equipped with non toxic Easyfil silicone and stainless steel supports. Lid has double handle and latching closing system.

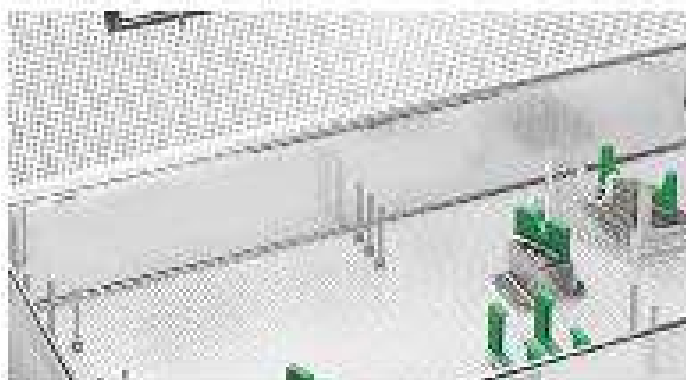

[FRA]

Ils sont équipés de supports Easyfil en silicone atoxique et acier inoxydable. Le couvercle a double poignée et fermeture à verrouillage.



**PANIER ET CALAGE POUR
ROBOT DA VINCI**

***BASKET AND CUSHIONING
FOR DA VINCI ROBOT***

Baskets for instruments —
Paniers pour Instruments



ART IN'SURG - CCM	L	l	H	N° of instruments — N° d'instruments
8130213 - 7902CVSL	890	240	70	6 x 28
8130217 - 7902CVSL-3	890	175	70	3 x 28

(ENG)

They are equipped with 2 non toxic Easyfil silicone and stainless steel supports. Ed with handle and double latching closing system.

(FRA)

ils sont équipés de 2 supports Easyfil en silicone atoxique et acier inoxydable. Le couvercle a une poignée et une double fermeture à loupement.



Baskets for 3D optic —
Paniers pour optique 3D



ART IN'SURG - CDM	L	l.	h.	N. of instruments — N. d'instruments
B130218 - 64/5D-VSL	600	120	80	1 x optic 1 x optique

(EN)

They are equipped with non toxic Easyfit silicone and stainless steel supports. Lid with handle and lidling double closing system.



(FR)

Ils sont équipés de supports Easyfit en silicone atoxique et acier inoxydable. Le couvercle a une poignée et une double fermeture soignée.



Laparoscopic frames

Supports pour laparoscopie

(ENG)

Laparoscopic frames are very useful for the creation of a single patient laparoscopic surgery kit. The sturdy wire frames, entirely made in stainless steel AISI304, allows the correct steam circulation all around the laparoscopic instruments. Moreover thanks to its design, Laparoscopic frame can be used to extract aseptically the entire kit from sterilisation packaging and safely place all the instruments on the instruments table.

(FRA)

Les supports pour laparoscopie sont très utiles pour la création de kits séparés pour la chirurgie laparoscopique du patient. Le support en fil métallique entièrement en acier inoxydable AISI304, permet la correcte circulation de la vapeur pour des instruments laparoscopiques. En outre, grâce à son design, le support pour laparoscopie peut être utilisé pour extraire, de façon aseptique, de l'emballage de stérilisation le kit entier et placer tous les instruments sur la table en toute sécurité.

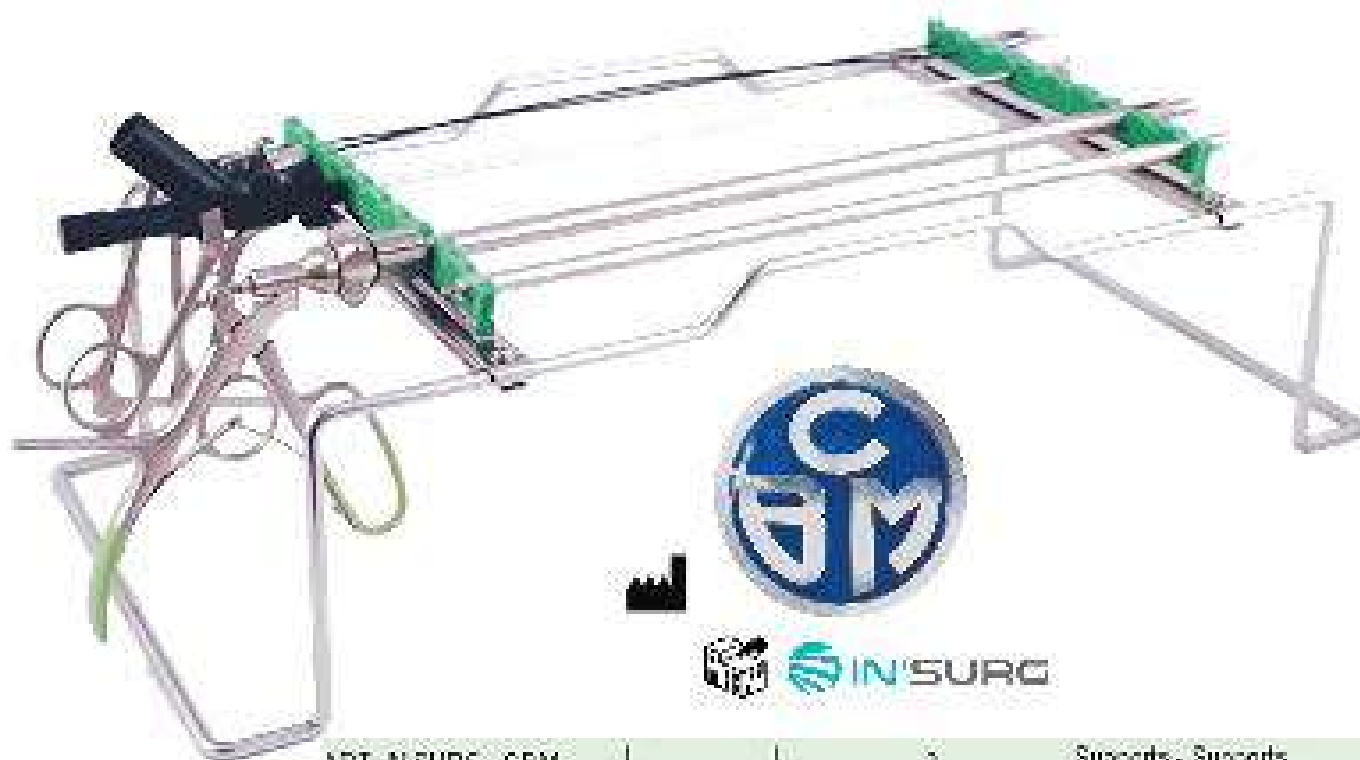

ART. IN'SURG - CDM	L	I	A	Supports - Supports
S130219 - FKE225	508	221	142	2 x A
S130220 - FKE226	508	221	152	2 x B
S130221 - FKE227	508	221	152	2 x C
S130222 - FKE222	348	221	102	2 x A
S130223 - FKE223	348	221	112	2 x B
S130224 - FKE224	348	221	112	2 x C

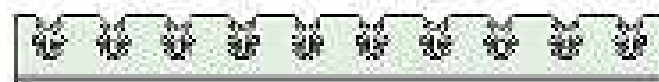

A - S130012

Easy Fit page 103/116

A = S130012 - S1734030810

B = S130026 - S1733051509

C = S130037 - S1733183116



B - S130026



C - S130037

Arthroscopic instruments frames

Supports pour instruments d'arthroscopie

(ENG)

Arthroscopic instruments frames are useful to create sets for unique procedure. The stainless steel Aisi304 strong structure, together with Easyfit silicone supports, allow to put arthroscopic instruments and Kerison punches in a functional way. Arthroscopic instruments frames can be fixed inside perforated sheet basins using screws.



S130227 - KERR-S1

(FRA)

Les supports pour les instruments d'arthroscopie sont utiles pour créer des sets à procédure unique. La structure solide en acier inoxydable Aisi304, avec les supports en silicone Easyfit, permet de loger de manière fonctionnelle les instruments pour arthroscopie et les rongeurs de Kerison. Les supports pour les instruments d'arthroscopie peuvent être fixés à l'intérieur de bacs en tôle perforée par les vis.



S130226 - ARTRO-S1

ART INSURG - CBM	L	I	h	N. of instruments — N. d'instruments
S130225 - ARTRO-S1	232	135	70	13 x 83+4
S130226 - ARTRO-S2	232	135	70	18 x 83+4
S130227 - KERR-S1	232	145	70	11 x 83+0 Kerison
S130228 - B886	Spare screws 10 pcs Vis de rechange 10 pièces			

Each support is supplied with 4 screws - Chaque support est fourni avec 4 vis.

ART IN'SURG - CBM	L	l	h	Soft Lips
S130229 - 2719T	270	190	35	2xL
S130230 - 77T	270	170	35	2xT
S130231 - 77TH	270	170	35	2xL
S130232 - 772T	200	170	35	2xT
S130233 - 772TH	200	170	35	2xL
S130234 - 63M4L	220	50	35	2xT
S130235 - 67S	170	135	35	1xT
S130236 - 63T	170	50	35	2xT



T

Soft Lips Crosswise — Transversal

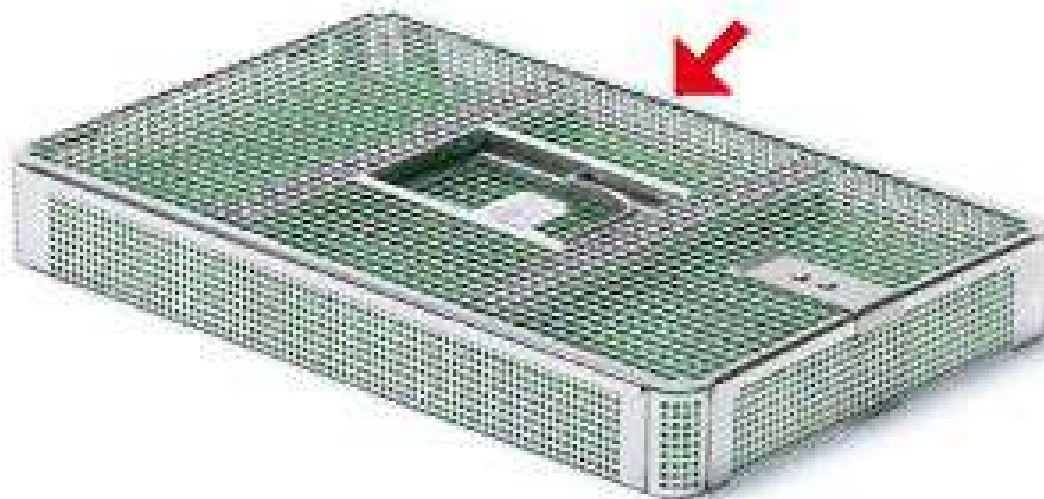
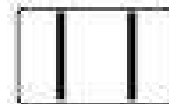

L

Soft Lips Lengthwise — Longitudinal



ART. INSURG - CRM	L	I	h	N° instruments - N° instruments
S130237 - 67/2CR	140	70	40	1x Dental Handpiece 1x Poignée dentaire
S130238 - 67/3CR	140	70	40	2x Dental Handpiece 2x Poignée dentaire



ART. INSURG - CRM	L	I	h	N° instruments - N° instruments
S130239 - 67/1CR	160	70	30	2x Dental Handpiece 2x Poignée dentaire



ART. INSURG - CRM	L	I	h	N° instruments - N° instruments
S130240 - 57CR	180	70	35	5x 00-0
*Art. 1d - Area outside				

SOMMAIRE

TIRE COMEDON - TIRE FIBROME.....	1199
<i>COMEDON EXTRACTOR - MYOMA SCREW</i>	
TITAN ULTRA :	
CANULE.....	1200
<i>TITAN - SUCTION CANNULA</i>	
CISEAUX CORPS PLAT.....	1202
<i>TITAN - SCISSORS FLAT BODY</i>	
CISEAUX CORPS ROND.....	1210
<i>TITAN- SCISSORS ROUND BODY</i>	
CLAMP BULLDOG.....	1220
<i>TITAN- BULLDOG CLAMP</i>	
CROCHET / COUTEAU.....	1221
<i>TITAN - HOOK</i>	
CURETTE.....	1223
<i>TITAN - CURETTE</i>	
DILATATEUR.....	1224
<i>TITAN - DILATATOR</i>	
PINCE A DISSEQUER CORPS PLAT.....	1225
<i>TITAN- DISSECTING FORCEPS FLAT BODY</i>	
PINCE A DISSEQUER CORPS ROND.....	1230
<i>TITAN - DISSECTING FORCEPS ROUND BODY</i>	
PORTE AIGUILLE CORPS PLAT.....	1240
<i>TITAN - NEEDLE HOLDER FLAT BODY</i>	
PORTE AIGUILLE CORPS ROND.....	1243
<i>TITAN - NEEDLE HOLDER ROUND BODY</i>	
RUGINE.....	1248
<i>TITAN - RASPATORY</i>	
SET VASCULAIRE.....	1249
<i>TITAN VASCULAR SET</i>	
TORD BROCHE.....	1251
<i>TWIST PIN</i>	
TOURNEVIS.....	1252
<i>SCREWDRIVER</i>	
TOURNIQUET.....	1253
<i>TOURNIQUET</i>	
TREPAN.....	1254
<i>HAND DRILLS</i>	



T

RETRO 'SPECTIVE

Armand TROUSSEAU
(14 octobre 1801 - 23 juin 1867)

était un **médecin, clinicien et homme politique** français ayant effectué des recherches sur **la fièvre jaune**. Il fût récompensé pour ses travaux. Il sera l'**un des premiers à appliquer la trachéotomie**. Son nom sera donné à une **contracture de la main (signe de Trousseau)**, ainsi qu'à **un dilatateur et une canule**.

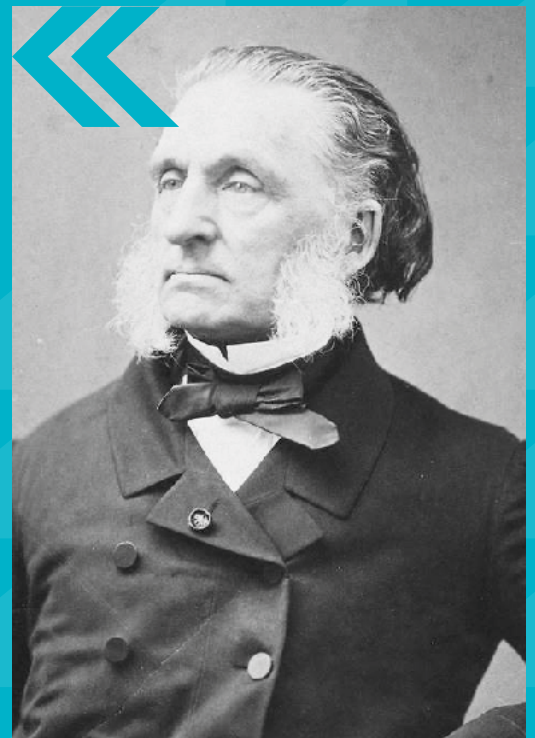

TIRE COMEDON - TIRE FIBROME COMEDON EXTRACTOR - MYOMA SCREW

TIRE COMEDON UNNA 120 MM

T025896 UNNA COMEDON EXTRACTOR 120 MM

TIRE FIBROME DOYEN 170 MM SIMPLE

T035897 DOYEN MYOMA SCREW 170 MM SINGLE



TITAN - CANULE

www.in-surg.fr

T

TITAN - SUCTION CANNULA

CANULE DEBAKEY 2,5 x 48 MM
TITAN ULTRA

T045898 TITAN ULTRA DEBAKEY
SUCTION CANNULA
2,5 x 48 MM

CANULE DEBAKEY 3 x 48 MM
TITAN ULTRA

T045899 TITAN ULTRA DEBAKEY
SUCTION CANNULA
3 x 48 MM

CANULE DEBAKEY
3,5 x 48 MM TITAN ULTRA

T045900 TITAN ULTRA
DEBAKEY SUCTION
CANNULA 3,5 x 48 MM

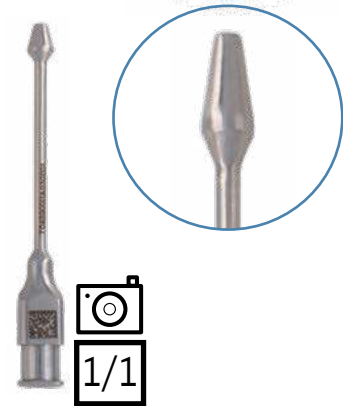
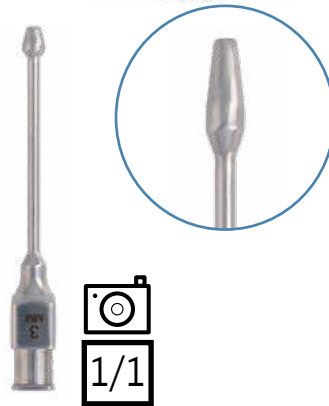
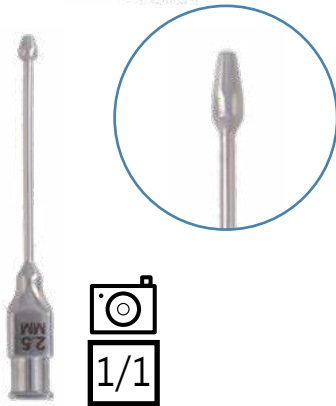

BOITE PERFOREE POUR MICRO CHIRURGIE

T025896 PERFORATED BOX FOR MICRO-SURGERY





IN'SURG
TITAN ULTRA

L'INSTRUMENT CHIRURGICAL
QUI VOUS CORRESPOND

Garantie
totale
2 ANS
sans conditions

TOUS NOS PRODUITS TITAN ULTRA SONT GARANTIS 2 ANS ET REMPLACÉS SANS CONDITIONS

SPÉCIFICITÉS :

Les lames des ciseaux sont en **acier inoxydable** pour une qualité de coupe optimale.

Affûtage possible sur l'ensemble des ciseaux de la gamme TITAN ULTRA

La présence d'un **contrepoids** permet d'obtenir un meilleur équilibre

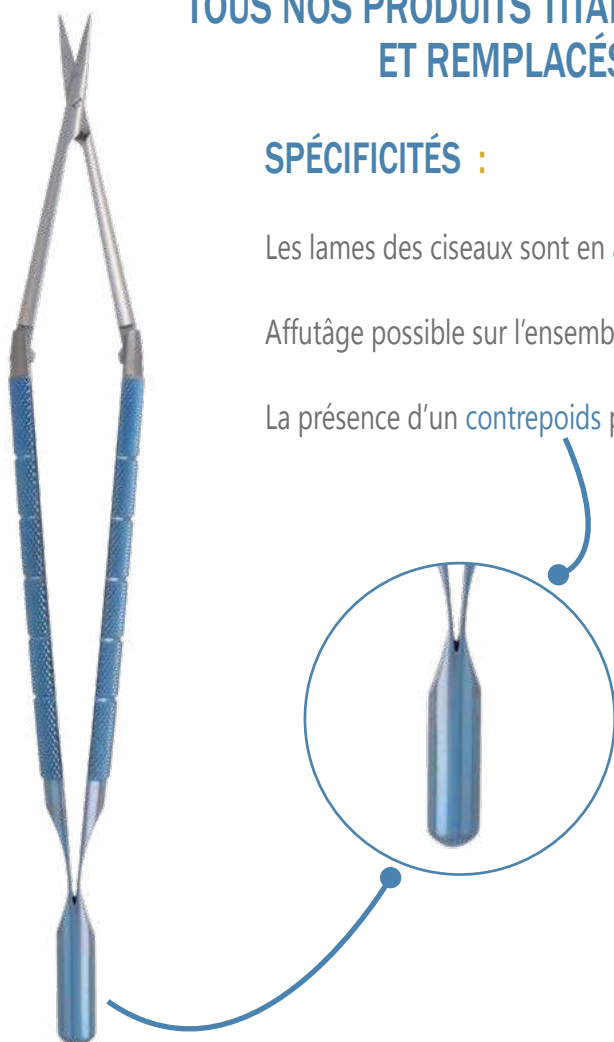

!!! AVANTAGE !!!

**2 X PLUS LEGER QUE
L'ACIER INOXYDABLE**



TITAN - CISEAUX CORPS PLAT

www.in-surg.fr

T

TITAN - SCISSORS FLAT BODY

CISEAUX 0.8 X 0.2 X 160 MM COURBE MOUSSE CORPS PLAT TITAN ULTRA

T045901 TITAN ULTRA SCISSOR 0.8 X 0.2 X 160 MM CURVED BLUNT FLAT BODY

IN'SURG
TITAN ULTRA

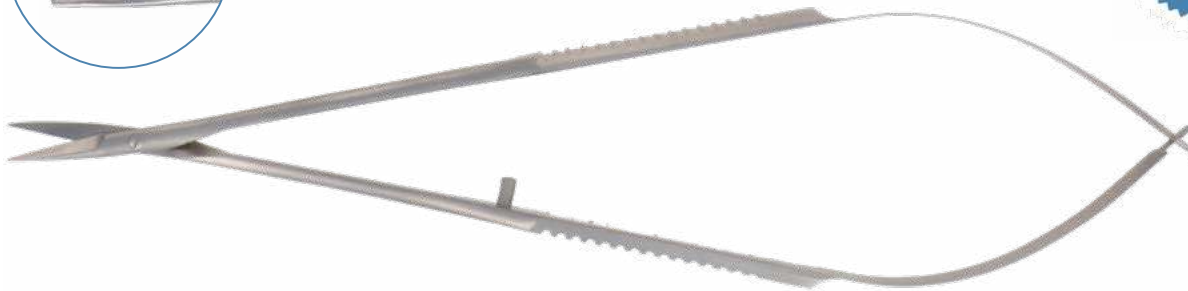
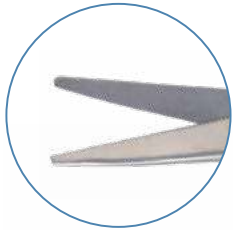

Garantie
totale
2 ANS
sans conditions

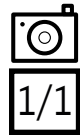

CISEAUX 0.2 X 0.2 X 160 MM COURBE CORPS PLAT TITAN ULTRA

T045902 TITAN ULTRA SCISSOR 0.2 X 0.2 X 160 MM CURVED FLAT BODY

IN'SURG
TITAN ULTRA

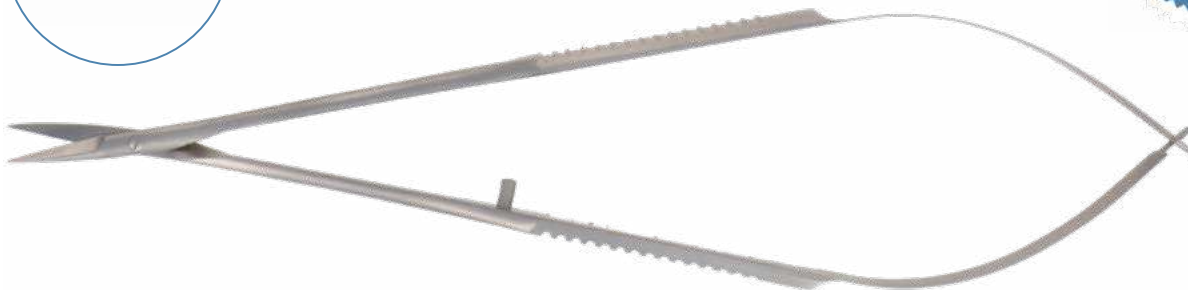

Garantie
totale
2 ANS
sans conditions



CISEAUX 0.5 X 0.2 X 160 MM COUDE A 30° MOUSSE CORPS PLAT TITAN ULTRA

T045903 TITAN ULTRA SCISSOR 0.5 X 0.2 X 160 MM ANGLED AT 30° BLUNT FLAT BODY

IN'SURG
TITAN ULTRA

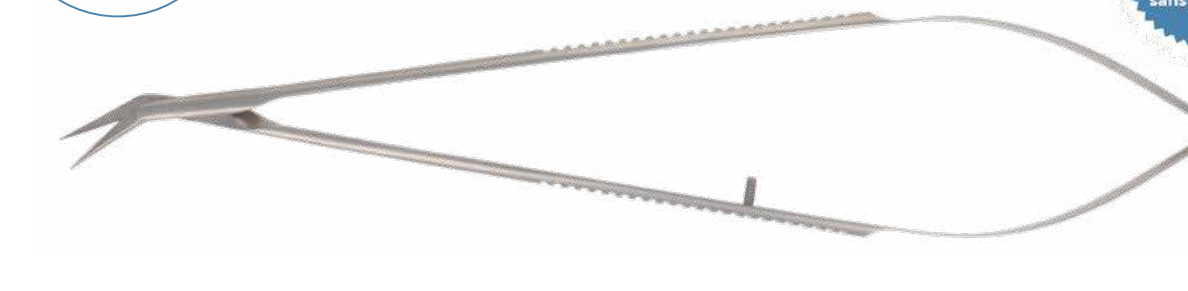

Garantie
totale
2 ANS
sans conditions

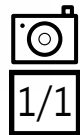

CISEAUX 0.8 X 0.2 X 160 MM DROIT MOUSSE LAMES CRANTEES CORPS PLAT TITAN ULTRA
T045905 TITAN ULTRA SCISSOR 0.8 X 0.2 X 160 MM STRAIGHT BLUNT SERRATED BLADES FLAT BODY

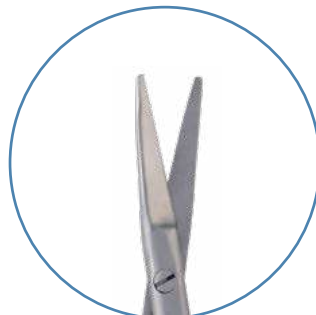
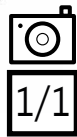

MOUSSE
BLUNT

0.8 X 0.2 X 160 MM

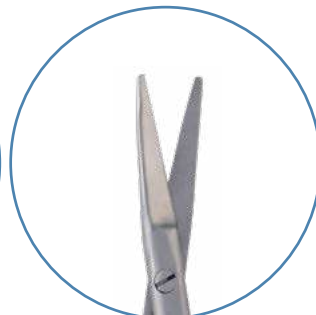

MOUSSE LAMES
CRANTEES
BLUNT SERRATED BLADES

0.8 X 0.2 X 160 MM



TRES FIN
VERY BENT

0.2 X 0.2 X 160 MM

REFERENCE
REFERENCE

T045904

T045905

T045906

CISEAUX 175 MM POINTU COUDE 30° CORONAIRE CORPS PLAT TITAN ULTRA
T045907 TITAN ULTRA SCISSOR 175 MM SHARP ANGLED 30° CORONARY FLAT BODY



COUDE A 45°
ANGLED 45°

T045908



COUDE A 60°
ANGLED 60°

T045909



COUDE A 90°
ANGLED 90°

T045910



COUDE A 120°
ANGLED 120°

T045911

CISEAUX 0.2 X 0.2 X 180 MM COURBE
POINTU CORPS PLAT TITAN ULTRA

T045912 *TITAN ULTRA SCISSOR 0.2 X 0.2 X 180 MM
CURVED SHARP FLAT BODY*

CISEAUX 3.9 X 0.5 X 180 MM DROIT LAMES
CROCHETS CORPS PLAT TITAN ULTRA

T045913 *TITAN ULTRA SCISSOR 3.9 X 0.5 X
180 MM STRAIGHT BLADES HOOKS
FORM FLAT BODY*

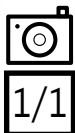

CISEAUX 0.6 X 0.3 X 200 MM COUDE
BAIONNETTE 1 LAME BOUTONNEE CORPS
PLAT TITAN ULTRA

T045914 *TITAN ULTRA SCISSOR 0.6 X 0.3 X
200 MM ANGLED BAYONET 1
BOUTONNE BLADE FLAT BODY*

CISEAUX 0.2 X 0.2 X 200 MM COURBE BAOINETTE
POINTU CORPS PLAT TITAN ULTRA

T045915 *TITAN ULTRA SCISSOR 0.2 X 0.2 X 200 MM
CURVED BAYONET SHARP FLAT BODY*

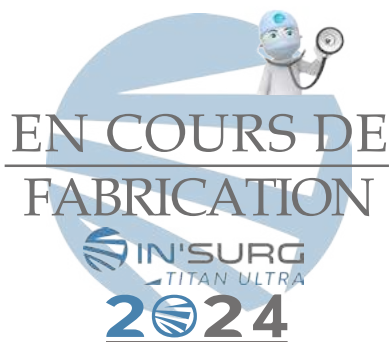

CISEAUX 0.8 X 0.5 X 200 MM DROIT
BAIONNETTE MOUSSE CORPS PLAT
TITAN ULTRA

T045916 TITAN ULTRA SCISSOR 0.8 X 0.5 X 200 MM
STRAIGHT BAYONET BLUNT FLAT BODY

CISEAUX 0.2 X 0.2 X 200 MM DROIT BAIONNETTE
POINTU CORPS PLAT TITAN ULTRA

T045917 TITAN ULTRA SCISSOR 0.2 X 0.2 X 200 MM
STRAIGHT BAYONET SHARP FLAT BODY

 IN'SURG
TITAN ULTRA

Garantie
totale
2 ANS
sans conditions



CISEAUX 0.2 X 0.2 X 200 MM DROIT POINTU
CORPS PLAT TITAN ULTRA

T045920 *TITAN ULTRA SCISSOR 0.2 X 0.2 X 200 MM
STRAIGHT SHARP FLAT BODY*

CISEAUX 0.8 X 0.2 X 200 MM DROIT LAMES
CRANTEES CORPS PLAT TITAN ULTRA

T045919 *TITAN ULTRA SCISSOR 0.8 X 0.2 X 200 MM
STRAIGHT SERRATED BLADES FLAT BODY*

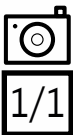

CISEAUX 0.7 X 0.3 X 200 MM COUDE A 45° 1
LAME BOUTONNEE CORPS PLAT TITAN
ULTRA

T045918 *TITAN ULTRA SCISSOR 0.7 X 0.3 X 200 MM
ANGLED 45° 1 BOUTONNE BLADE FLAT
BODY*



CISEAUX 0.2 X 0.2 X 230 MM COURBE BAIONNETTE POINTU CORPS PLAT TITAN ULTRA

T045922 TITAN ULTRA SCISSOR 0.2 X 0.2 X 230 MM CURVED BAYONET SHARP FLAT BODY



COURBE MOUSSE
CURVED BLUNT
0.7 X 0.2 X 230 MM
T045921



COURBE POINTU
CURVED SHARP
0.2 X 0.2 X 230 MM
T045922



DROIT MOUSSE
STRAIGH BLUNT
0.7 X 0.2 X 230 MM
T045923

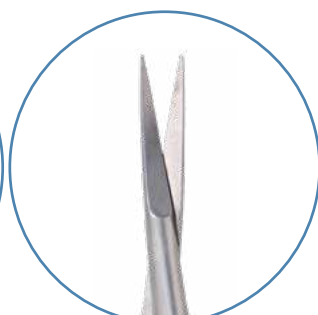

DROIT POINTU
STRAIGHT SHARP
0.2 X 0.2 X 230 MM
T045924

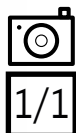

TITAN - CISEAUX CORPS ROND

www.in-surg.fr

T

TITAN - SCISSORS ROUND BODY

CISEAUX 0.6 X 0.2 X 150 MM COURBE MOUSSE CORPS ROND TITAN ULTRA

T045925 TITAN ULTRA SCISSOR 0.6 X 0.2 X 150 MM CURVED BLUNT ROUND BODY

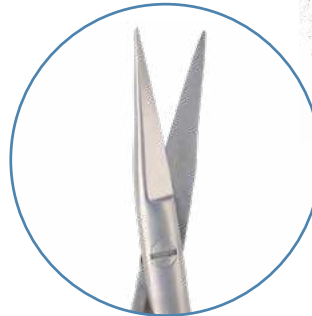

COURBE POINTU
CURVED SHARP
0.2 X 0.2 X 150 MM
T045926

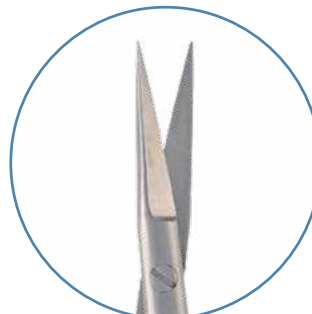

DROIT POINTU
STRAIGHT SHARP
0.2 X 0.2 X 150 MM
T045927



DROIT POINTU LAMES COURTES
STRAIGHT SHARP SHORT BLADES
0.2 X 0.2 X 150 MM
T045928

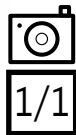

CISEAUX 0.2 X 0.2 X 180 MM POINTU ANGULE A 55 ° CORPS ROND TITAN ULTRA
 T045929 TITAN ULTRA SCISSOR 0.2 X 0.2 X 180 MM SHARP ANGULATED 55 ° ROUND BODY

 IN'SURG
 TITAN ULTRA

Garantie
 totale
2 ANS
 sans conditions

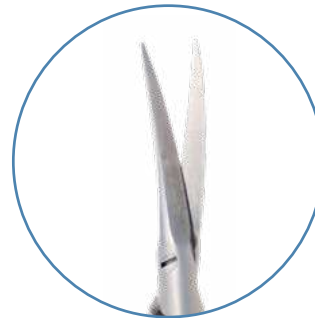

COURBE POINTU
CURVED SHARP
 0.2 X 0.15 X 180 MM
T045931



COURBE MOUSSE
CURVED BLUNT
 0.7 X 0.15 X 180 MM
T045930

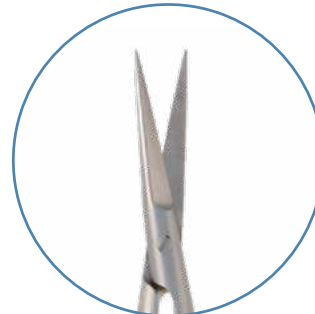

DROIT POINTU LAMES COURTES
STRAIGHT SHARP SHORT BLADES
 0.2 X 0.15 X 180 MM
T045934



DROIT MOUSSE
STRAIGHT BLUNT
 0.7 X 0.15 X 180 MM
T045932



DROIT POINTU LAMES LONGUES
STRAIGHT SHARP LONG BLADES
 0.2 X 0.15 X 180 MM
T045933

CISEAUX 200 MM COUDE A 25° CORONAIRE CORPS ROND TITAN ULTRA
T045935 TITAN ULTRA SCISSOR 200 MM ANGLED 25° CORONARY ROUND BODY

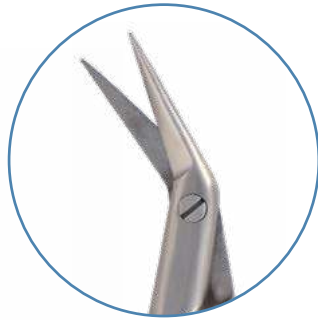

COUDE A 45°
ANGLED 45°

T045936



COUDE A 60°
ANGLED 60°

T045937



COUDE A 90°
ANGLED 90°

T045938



COUDE A 120°
ANGLED 120°

T045939

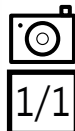

CISEAUX 0.6 X 0.3 X 200 MM COURBE MOUSSE VASCULAIRE CORPS ROND TITAN ULTRA

T045940 TITAN ULTRA SCISSOR 0.6 X 0.3 X 200 MM CURVED BLUNT VASCULAR ROUND BODY

IN'SURG
TITAN ULTRA

Garantie
totale
2 ANS
sans conditions



DROIT MOUSSE
STRAIGHT BLUNT
0.6 X 0.3 X 200 MM
T045941

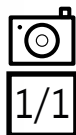

CISEAUX 0.2 X 0.2 X 155 MM COURBE POINTU DOUBLE ARTICULATION CORPS ROND TITAN ULTRA
T045944 TITAN ULTRA SCISSOR 0.2 X 0.2 X 155 MM CURVED SHARP DOUBLE ARTICULATION ROUND BODY

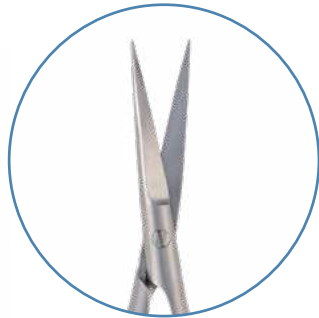

POINTU FIN ANGLE
SHARP BENT ANGULATED
0.2 X 0.2 X 155 MM
T045942

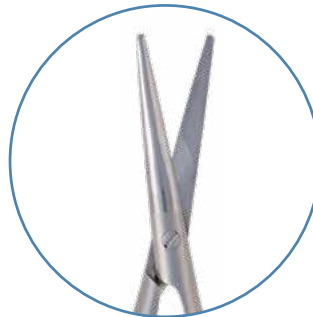

COURBE MOUSSE
CURVED BLUNT
0.7 X 0.2 X 155 MM
T045943

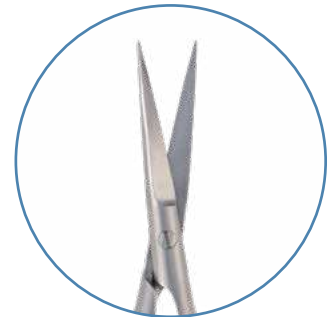

COURBE POINTU
CURVED SHARP
0.2 X 0.2 X 155 MM
T045944

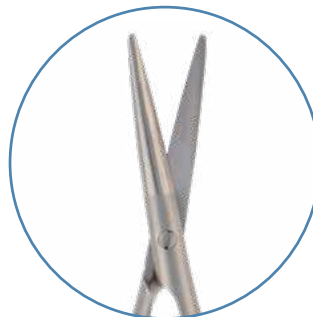

DROIT MOUSSE
STRAIGH BLUNT
0.7 X 0.2 X 155 MM
T045945

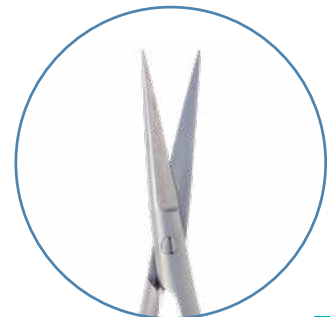

DROIT POINTU
STRAIGHT SHARP
0.2 X 0.2 X 155 MM
T045946

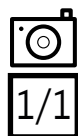

TITAN - SCISSORS ROUND BODY

CISEAUX 0.45 X 0.2 X 185 MM COURBE
 BISEAU A GAUCHE DOUBLE ARTICULATION
 CORPS ROND AVEC CONTREPOIDS TITAN ULTRA

T045947 TITAN ULTRA SCISSOR 0.45 X 0.2 X 185 MM
 CURVED LEFT BEVEL DOUBLE
 ARTICULATION WITH COUNTERWEIGHT
 ROUND BODY

CISEAUX 0.45 X 0.2 X 185 MM DROIT BISEAU
 A GAUCHE DOUBLE ARTICULATION CORPS
 ROND AVEC CONTREPOIDS TITAN ULTRA

T045949 TITAN ULTRA SCISSOR 0.45 X 0.2 X 185 MM
 STRAIGHT LEFT BEVEL DOUBLE
 ARTICULATION ROUND BODY WITH
 COUNTERWEIGHT

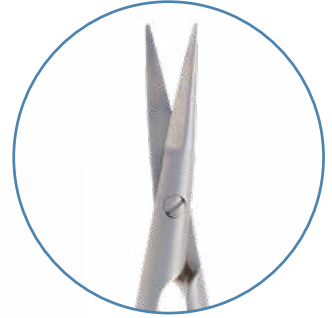
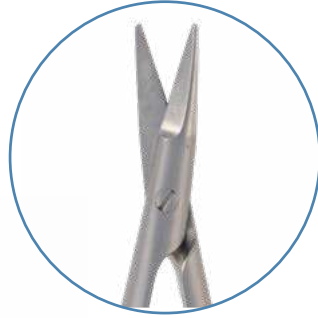

 IN'SURG
 TITAN ULTRA

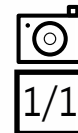

CISEAUX 0.45 X 0.2 X 185 MM COURBE BISEAU
A DROITE DOUBLE ARTICULATION CORPS
ROND AVEC CONTREPOIDS TITAN ULTRA

T045948 *TITAN ULTRA SCISSOR 0.45 X 0.2 X 185 MM
CURVED RIGHT BEVEL DOUBLE
ARTICULATION ROUND BODY WITH
COUNTERWEIGHT*



CISEAUX 0.45 X 0.2 X 185 MM DROIT BISEAU
A DROITE DOUBLE ARTICULATION CORPS
ROND AVEC CONTREPOIDS TITAN ULTRA

T045950 *TITAN ULTRA SCISSOR 0.45 X 0.2 X 185 MM
STRAIGHT RIGHT BEVEL DOUBLE
ARTICULATION ROUND BODY WITH
COUNTERWEIGHT*

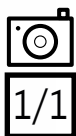
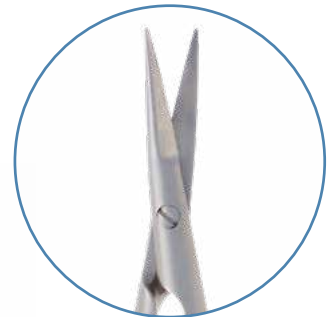

TITAN - SCISSORS ROUND BODY

CISEAUX 0.45 X 0.2 X 210 MM COURBE BISEAU
A GAUCHE MOUSSE DOUBLE ARTICULATION
CORPS ROND AVEC CONTREPOIDS TITAN
ULTRA

T045953 *TITAN ULTRA SCISSOR 0.45 X 0.2 X 210 MM
CURVED LEFT BEVEL BLUNT DOUBLE
ARTICULATION ROUND BODY WITH
COUNTERWEIGHT*

CISEAUX 0.45 X 0.2 X 210 MM DROIT BISEAU
A GAUCHE MOUSSE DOUBLE ARTICULATION
CORPS ROND AVEC CONTREPOIDS TITAN
ULTRA

T045955 *TITAN ULTRA SCISSOR 0.45 X 0.2 X 210 MM
STRAIGHT LEFT BEVEL BLUNT DOUBLE
ARTICULATION ROUND BODY
COUNTERWEIGHT*



IN'SURG
TITAN ULTRA

Garantie
totale
2 ANS
sans conditions

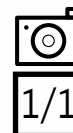
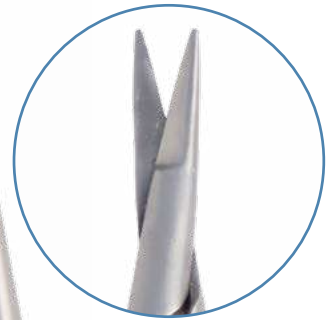
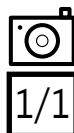

CISEAUX 0.45 X 0.2 X 210 MM COURBE BISEAU
A DROITE MOUSSE DOUBLE ARTICULATION
CORPS ROND AVEC CONTREPOIDS TITAN
ULTRA

T045954 *TITAN ULTRA SCISSOR 0.45 X 0.2 X 210 MM
CURVED RIGHT BEVEL BLUNT DOUBLE
ARTICULATION ROUND BODY WITH
COUNTERWEIGHT*

CISEAUX 0.45 X 0.2 X 210 MM DROIT BISEAU
A DROITE MOUSSE DOUBLE ARTICULATION
CORPS ROND AVEC CONTREPOIDS TITAN
ULTRA

T045956 *TITAN ULTRA SCISSOR 0.45 X 0.2 X 210 MM
STRAIGHT RIGHT BEVEL BLUNT DOUBLE
ARTICULATION ROUND BODY WITH
COUNTERWEIGHT*



 **IN'SURG**
TITAN ULTRA

**Garantie
totale
2 ANS**
sans conditions

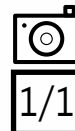
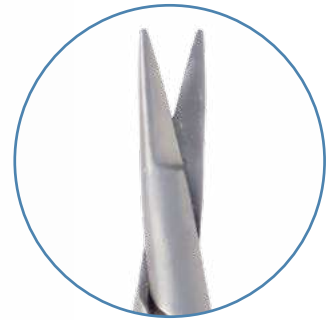
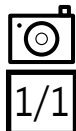

TITAN - SCISSORS ROUND BODY

CISEAUX 0.3 X 0.1 X 200 MM COURBE DOUBLE
ARTICULATION CORPS ROND AVEC
CONTREPOIDS TITAN ULTRA

T045951 TITAN ULTRA SCISSOR 0.3 X 0.1 X 200 MM
CURVED DOUBLE ARTICULATION ROUND
BODY WITH COUNTERWEIGHT

CISEAUX 0.3 X 0.1 X 200 MM DROIT DOUBLE
ARTICULATION CORPS ROND AVEC
CONTREPOIDS TITAN ULTRA

T045952 TITAN ULTRA SCISSOR 0.3 X 0.1 X 200 MM
STRAIGHT DOUBLE ARTICULATION ROUND
BODY WITH COUNTERWEIGHT



 IN'SURG
TITAN ULTRA

Garantie
totale
2 ANS
sans conditions

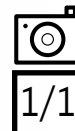
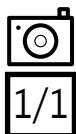

TITAN- BULLDOG CLAMP

CLAMP BULLDOG 8 X 47 MM COUDE TITAN
ULTRA

T045957 TITAN ULTRA BULLDOG CLAMP 8 X 47 MM
CURVED

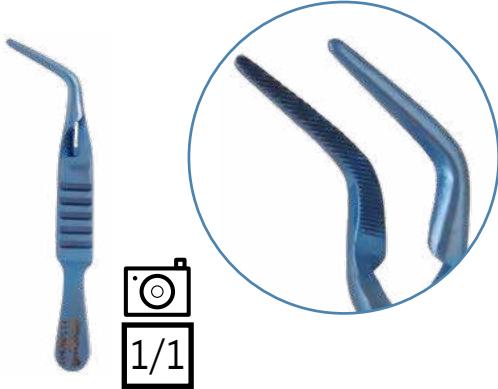

CLAMP BULLDOG 12 X 47 MM COUDE TITAN
ULTRA

T045959 TITAN ULTRA BULLDOG CLAMP 12 X 47 MM
CURVED

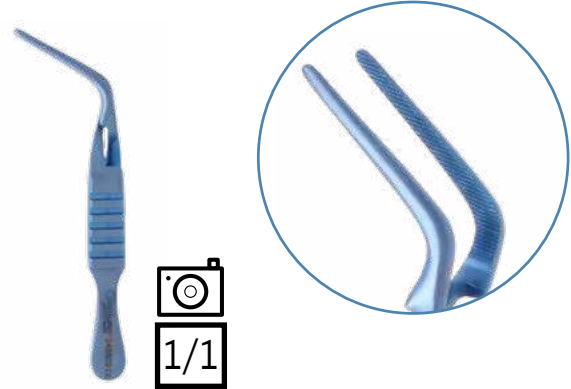

CLAMP BULLDOG 12 X 47 MM COUDE INOX
TITAN ULTRA

T045958 TITAN ULTRA BULLDOG CLAMP 12 X 47 MM
CURVED STAINLESS STEEL

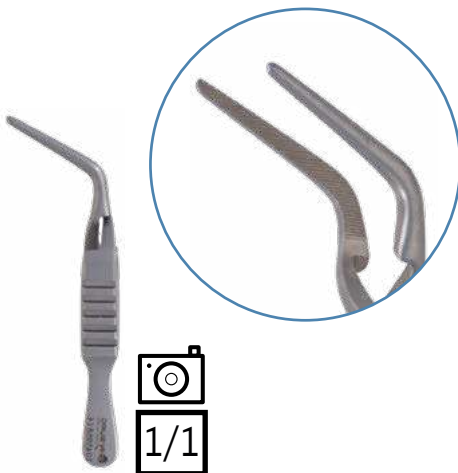

CLAMP BULLDOG 17 X 47 MM COUDE INOX
TITAN ULTRA

T045960 TITAN ULTRA BULLDOG CLAMP 17 X 47 MM
CURVED STAINLESS STEEL

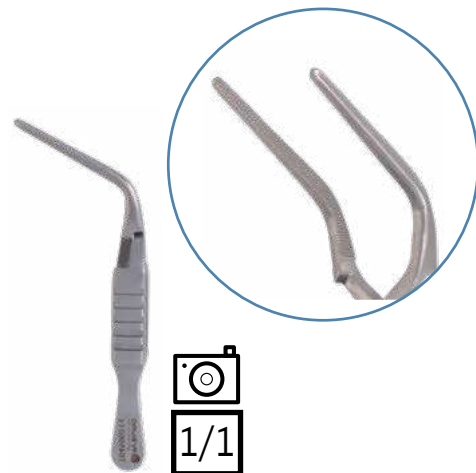

CROCHET RHOTON 0,9 X 186 MM COUDE A 2,2 MM A 90° A BOULE TITAN ULTRA

T046065 TITAN ULTRA RHOTON HOOK 0,9 X 186 MM ANGLED 2,2 MM A 90° WITH BALL



Garantie
totale
2 ANS
sans conditions



0,9 X 186 MM COUDE A 5,25 MM
A 90° A BOULE

ANGLED 90° WITH BALL

T046066



0,9 X 186 MM COUDE A 7,5 MM
A 40° A BOULE

ANGLED 40° WITH BALL

T046067



0,8 X 190 MM COUDE A 3,6 MM
A 90° A BOULE

ANGLED 90° WITH BALL

T046068



1,0 X 190 MM COUDE A 4,6 MM
A 45° A BOULE

ANGLED 45° WITH BALL

T046069



0,25 X 191 MM COUDE A 2,5 MM
A 45° A BOULE

ANGLED 45° WITH BALL

T046070

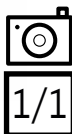

CROCHET SUR MANCHE TITAN BOUTONNE
DIAM 0,5 MM X 2.7 X 180 MM TITAN ULTRA

COUTEAU 2,8 x 180 MM COUDE A 90° TITAN ULTRA
T046083 TITAN ULTRA KNIFE 2,8 x 180 MM ANGLED 90°

T046084 TITAN ULTRA HOOK ON SUR HANDLE TITAN
BOUTTONED DIAM 0,5 MM X 2.7 X 180 MM



Ø 0.5 X 180 MM
COUDE A 90° BOUTONNE
ANGLED 90° BOUTTONED
T046085



Ø 0.6 X 3.1 X 180 MM
COUDE A 90°
ANGLED 90°
T046086



Ø 0,4 X 5.3 X 180 MM-
COUDE A 135°
ANGLED 135°
T046087



Ø 0.3 X 180 MM
T046092

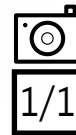
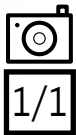

CURETTE RHOTON 1,3 X 2.2 X 190 MM COUDEE A 2,20 MM A 27° TITAN ULTRA
T046071 TITAN ULTRA RHOTON CURETTE 1,3 X 2.2 X 190 MM ANGLED 2,20 MM A 27°



DROITE
STRAIGHT
T046072

TITAN - DILATATOR

DILATATEUR CORON. 1 X 180 MM
TITAN ULTRA

T045961 TITAN ULTRA DILATATOR CORON.
1 X 180 MM

DILATATEUR TEFLON SUR MANCHE 1 X 210 MM
BOUTONNE TITAN ULTRA

T045965 TITAN ULTRA DILATATOR TEFLON ON THE
HANDLE 1 X 210 MM BOUTONNED

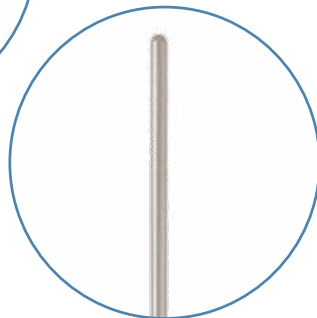
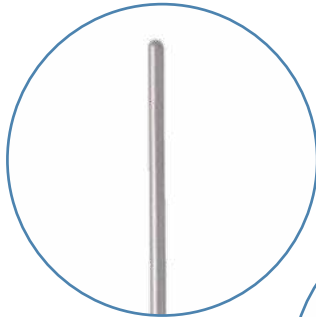

Ø 1,5 MM

T045962



Ø 2 MM

T045963

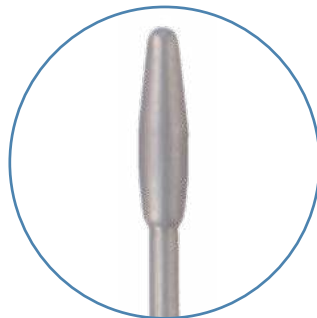

Ø 2,5 MM

T045964



Ø 1,5 MM

T045966



Ø 2 MM

T045967

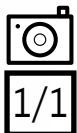

TITAN - PINCE A DISSEQUER CORPS PLAT

TITAN- DISSECTING FORCEPS FLAT BODY

PINCE DISS DEBAKEY 1,4 X 1,4 X 220 MM EN BAIONNETTE TITAN ULTRA

T046101 *TITAN ULTRA DEBAKEY DISSECTING FORCEPS 1,4 X 1,4 X 220 MM BAYONET*

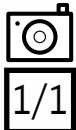

IN'SURG
 TITAN ULTRA

**Garantie
totale
2 ANS
sans conditions**



PINCE DISS DEBAKEY 1 X 1,2 X 150 MM TITAN ULTRA

T046096 TITAN ULTRA DEBAKEY DISSECTING FORCEPS 1 X 1,2 X 150 MM

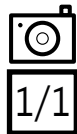

LARGEUR X LONGUEUR DU MORS
WIDTH X LENGTH JAWS

LONGUEUR LENGTH	1 X 1,2 MM	1,5 MM	2 X 2 MM	2 X 2,5 MM
150 MM	T046096	T046097 1,5 X 1,5 MM		
200 MM	T046098	T046100 1,5 X 3,5 MM	T046099	
240 MM	T046102	T046103 1,5 X 1,8 MM	T046104	T046105

TITAN - PINCE A DISSEQUER CORPS PLAT

TITAN - DISSECTING FORCEPS FLAT BODY

PINCE ADSON 1,0 X 1,4 X 130 MM DROITE MORS DEBAKEY CORPS PLAT TITAN ULTRA

T045970 *TITAN ULTRA ADSON FORCEPS 1,0 X 1,4 X 130 MM STRAIGHT DEBAKEY JAWS FLAT BODY*

IN'SURG
TITAN ULTRA

Garantie
totale
2 ANS
sans conditions

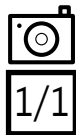
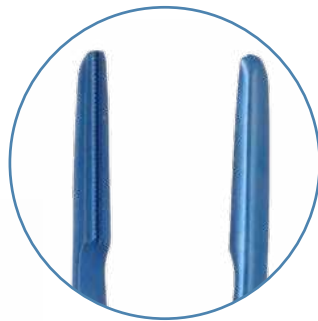

0.24 X 120 MM 1 X 2 GRIFFES
INCLINEES A 30°

1 X 2 TEETH INCLINED AT 30°

T045974



0,3 X 0,3 X 130 MM DROITE
MORS DIAMANTES
AVEC PLATEAU 8 MM

*STRAIGHT DIAMOND
JAWS WITH PLATFORM*

T045975



0,3 X 0,3 X 130 MM COURBE
MORS DIAMANTES
AVEC PLATEAU 10 MM

*CURVED DIAMOND
JAWS WITH PLATFORM*

T045976



1 X 1 X 130 MM DROITE
MORS STRIES

*STRAIGHT
STRIATED JAWS*

T045977



2 X 1.5 X 130 MM
MORS CANNELES

GROOVED JAWS

T045978

PINCE ADSON 0.4 X 145 MM 1 X 2 GRIFFES
INCLINEES A 90° CORPS PLAT TITAN ULTRA

PINCE 4 X 220 MM BAIONNETTE CORPS PLAT
TITAN ULTRA

T045979 TITAN ULTRA ADSON FORCEPS 0.4 X 145 MM
1 X 2 TEETH INCLINED AT 90° FLAT BODY

T045985 TITAN ULTRA FORCEPS 4 X 220 MM
BAYONET FLAT BODY



0,2 X 0,2 X 145 MM
DROITE POINTUE
MORS DIAMANTES
STRAIGHT SHARP
DIAMOND JAWS

T045980



Ø 6 MM

T045986

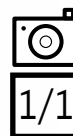

TITAN - PINCE A DISSEQUER CORPS PLAT

TITAN - DISSECTING FORCEPS FLAT BODY

PINCE 0.3 X 0.35 X 110 MM DROITE CORPS PLAT TITAN ULTRA

T045982 TITAN ULTRA FORCEPS 0.3 X 0.35 X 110 MM STRAIGHT FLAT BODY

Garantie totale
2 ANS
sans conditions

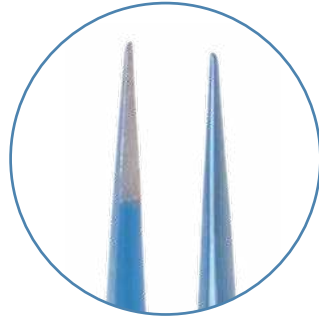

0.3 X 0.35 X 110 MM
ANGULEE A 45°
ANGULATED 45°

T045981

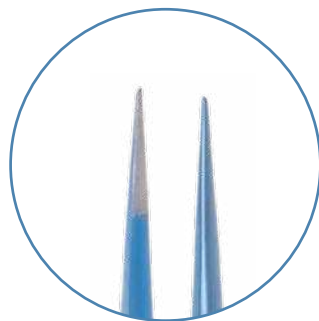
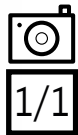

0.2 X 0.25 X 110 MM CORPS PLAT MORS DIAMANTES
FLAT BODY
DIAMOND JAWS

T045971

PINCE 0.25 X 0.25 X 135 MM DROITE A PLATEAU MORS DIAMANTES CORPS PLAT TITAN ULTRA

T045984 TITAN ULTRA FORCEPS 0.25 X 0.25 X 135 MM STRAIGHT WITH PLATFORM DIAMOND JAWS FLAT BODY

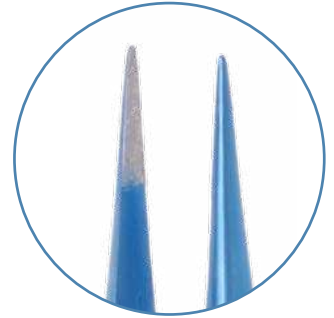

0.25 X 0.25 X 135 MM
COURBE A PLATEAU
MORS DIAMANTES
CURVED WITH PLATFORM
DIAMOND JAWS

T045983



TITAN - PINCE A DISSEQUER CORPS ROND

www.in-surg.fr

T

TITAN - DISSECTING FORCEPS ROUND BODY

PINCE TYPE COLIBRI 0,1 X 120 MM 1 X 2
GRIFFES INCLINEES A 30° CORPS ROND
TITAN ULTRA

T045987 TITAN ULTRA COLIBRI TYPE
FORCEPS 0,1 X 120 MM 1 X 2 TEETH
INCLINED AT 30° ROUND BODY

PINCE 0,4 X 0.3 X 120 MM DROITE POINTUE A
PLATEAU MORS DIAMANTES CORPS ROND
TITAN ULTRA

T045988 TITAN ULTRA FORCEPS 0.4 X 0.3 X 120 MM
STRAIGHT SHARP WITH PLATFORM DIAMOND
JAWS ROUND BODY

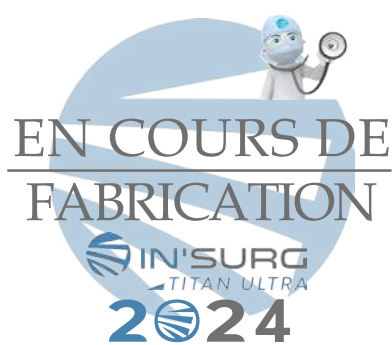

TITAN - PINCE A DISSEQUER CORPS ROND

TITAN - DISSECTING FORCEPS ROUND BODY

PINCE 0.3 X 0.3 X 135 MM DROITE CORPS ROND
A PLATEAU MORS DIAMANTES TITAN ULTRA

T045990 *TITAN ULTRA FORCEPS 0.3 X 0.3 X 135 MM
STRAIGHT ROUND BODY WITH PLATFORM
DIAMOND JAWS*



PINCE 0.5 X 0.4 X 135 MM MORS EN V A
PLATEAU MORS DIAMANTES CORPS ROND
TITAN ULTRA

T045989 *TITAN ULTRA FORCEPS 0.5 X 0.4 X 135 MM
JAWS V-FORM WITH PLATFORM STRIATED
ROUND BODY*

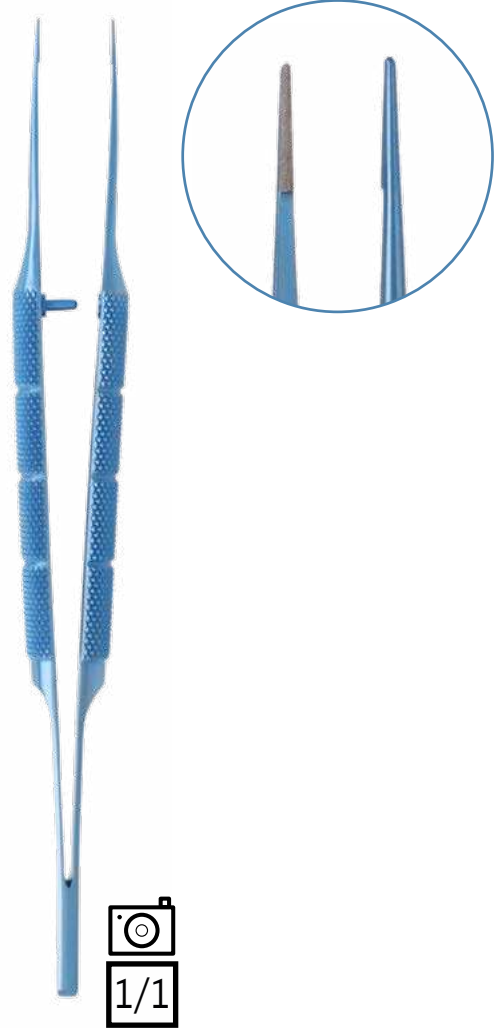

0,3 X 0,3 X 135 MM COURBE
A PLATEAU MORS DIAMANTES

*CURVED
WITH PLATFORM
DIAMOND JAWS*

T045992



0.4 X 0.5 X 135 MM
COURBE A PLATEAU

*CURVED
WITH PLATFORM*

T045991

PINCE DEBAKEY 1 X 1,4 X 150 MM DROITE
CORPS ROND TITAN ULTRA

T045993 TITAN ULTRA DEBAKEY FORCEPS
1 X 1,4 X 150 MM STRAIGHT
ATRAUMATIQUE ROUND BODY



PINCE 0,3 X 0,4 X 155 MM DROITE CORPS ROND AVEC
CONTREPOIDS MORS DIAMANTES TITAN ULTRA

T045995 TITAN ULTRA FORCEPS 0,3 X 0,4 X 155 MM
STRAIGHT DIAMOND JAWS ROUND BODY
WITH COUNTERWEIGHT



 **IN'SURG**
TITAN ULTRA

**Garantie
totale
2 ANS**
sans conditions

 EN COURS DE
FABRICATION
IN'SURG
2024

COURBE
CURVED
T045994



TITAN - PINCE A DISSEQUER CORPS ROND

TITAN - DISSECTING FORCEPS ROUND BODY

PINCE 0.3 X 0.3 X 160 MM DROITE MORS EN V RAINURES DIAMANTES A PLATEAU CORPS ROND TITAN ULTRA

T045998 *TITAN ULTRA FORCEPS 0.3 X 0.3 X 160 MM STRAIGHT V-GROOVE FORM WITH PLATFORM DIAMOND JAWS ROUND BODY*

PINCE 175 MM DROITE 1 X 2 GRIFFES CORPS ROND TITAN ULTRA

T045999 *TITAN ULTRA FORCEPS 175 MM STRAIGHT 1 X 2 TEETH ROUND BODY*

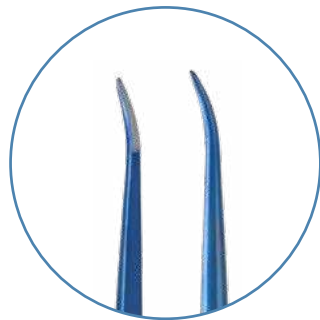
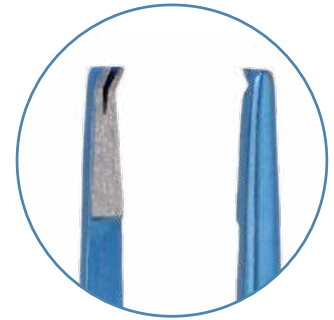

0.3 X 0.25 X 160 MM
COURBE
CURVED
T045996



0.3 X 0.25 X 160 MM
COUDEE
ANGLED
T045997

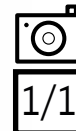
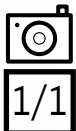

PINCE 0,3 X 0,4 X 175 MM DROITE MORS
DIAMANTES CORPS ROND A PLATEAU AVEC
CONTREPOIDS TITAN ULTRA

T046001 *TITAN ULTRA FORCEPS 0,3 X 0,4 X 175 MM
STRAIGHT DIAMOND JAWS WITH
PLATFORM WITH COUNTERWEIGHT
ROUND BODY*

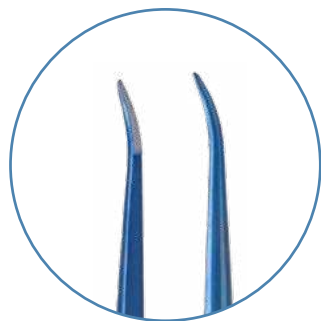
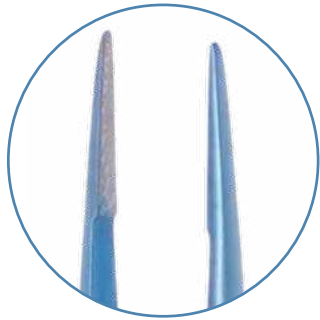

COURBE
CURVED
T046000

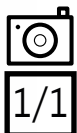

PINCE 0,4 X 0,3 X 178 MM DROITE MORS
DIAMANTES A PLATEAU CORPS ROND
TITAN ULTRA

T046002 *TITAN ULTRA FORCEPS 0,4 X 0,3 X 178 MM
STRAIGHT DIAMOND JAWS WITH
PLATFORM ROUND BODY*

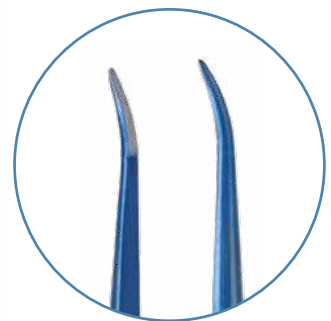
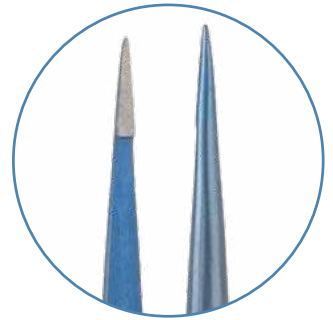

COURBE
CURVED
T046003

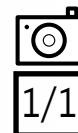

TITAN - PINCE A DISSEQUER CORPS ROND

TITAN - DISSECTING FORCEPS ROUND BODY

PINCE DEBAKEY 1 X 1 X 185 MM CORPS
ROND AVEC CONTREPOIDS TITAN ULTRA

T046004 *TITAN ULTRA DEBAKEY FORCEPS 1 X 1 X 185 MM
ROUND BODY WITH COUNTERWEIGHT*

PINCE DEBAKEY 1 X 1 X 210 MM CORPS
ROND AVEC CONTREPOIDS TITAN ULTRA

T046011 *TITAN ULTRA FORCEPS DEBAKEY
1 X 1 X 210 MM ROUND BODY WITH
COUNTERWEIGHT*

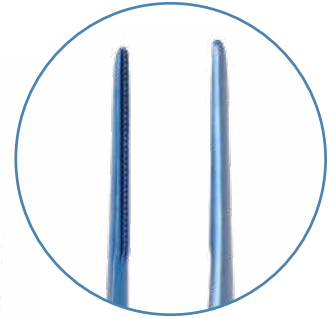
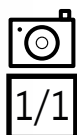
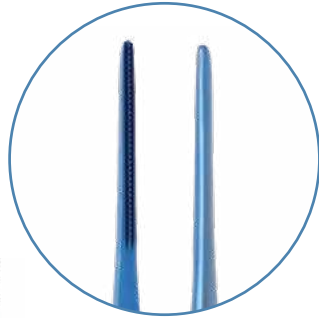

 **IN'SURG**
TITAN ULTRA

**Garantie
totale
2 ANS**
sans conditions

PINCE MILLS DIAM INT 0,75 X DIAM EXT 1,2 X 185 MM MORS DIAMANTES A PLATEAU CORPS ROND AVEC CONTREPOIDS TITAN ULTRA

T046005 TITAN ULTRA MILLS FORCEPS DIAM INT 0,75 X DIAM EXT 1,2 X 185 MM DIAMOND JAWS WITH PLATFORM ROUND BODY WITH COUNTERWEIGHT

PINCE MILLS DIAM INT 0,75 X DIAM EXT 1,2 X 185 MM MORS DIAMANTES A PLATEAU CORPS ROND AVEC CONTREPOIDS DOUBLE ARTICULATION TITAN ULTRA

T046006 TITAN ULTRA MILLS FORCEPS INT 0,75 X DIAM EXT 1,2 X 185 MM DIAMOND JAWS WITH PLATFORM ROUND BODY DOUBLE ARTICULATION WITH COUNTERWEIGHT

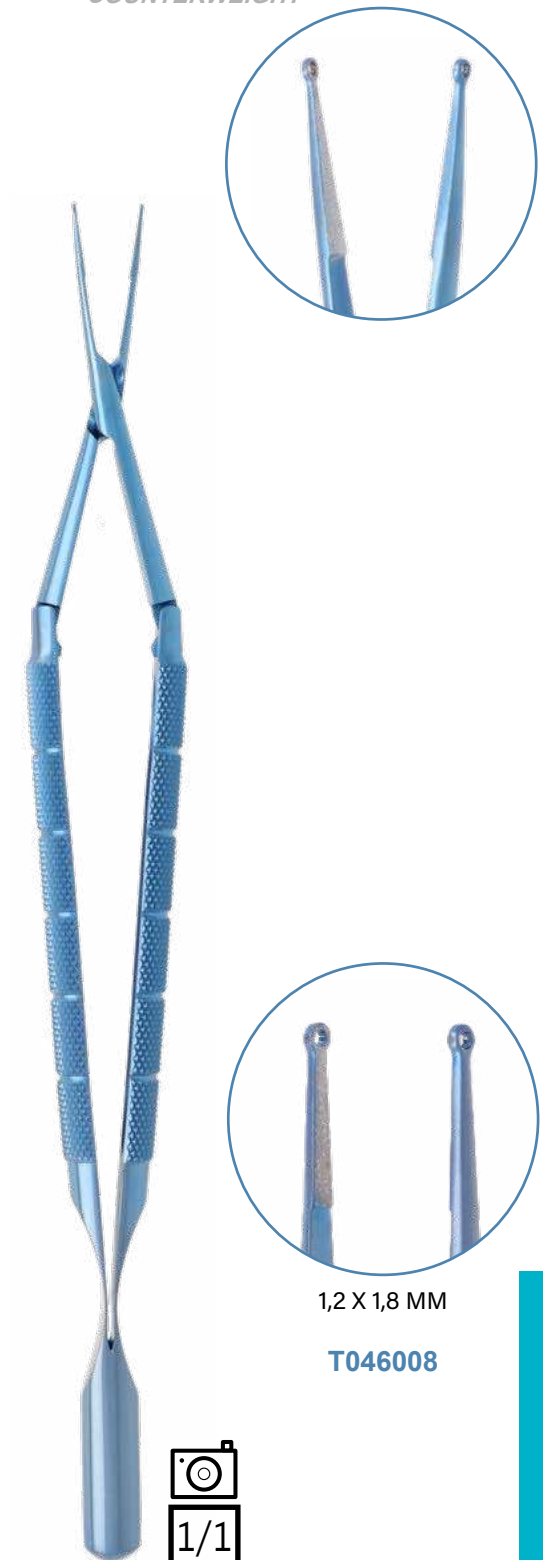

TITAN - PINCE A DISSEQUER CORPS ROND

TITAN - DISSECTING FORCEPS ROUND BODY

PINCE MILLS DIAM INT 0,75 X DIAM EXT 1,2 X 210 MM MORS DIAMANTES A PLATEAU CORPS ROND TITAN ULTRA

T046013 TITAN ULTRA MILLS FORCEPS INT 0,75 X DIAM EXT 1,2 X 210 MM DIAMOND JAWS WITH PLATFORM ROUND BODY



1,1 X 1,8 MM

T046014

PINCE MILLS DIAM INT 0,75 X DIAM EXT 1,2 X 210 MM MORS DIAMANTES A PLATEAU CORPS ROND DOUBLE ARTICULATION AVEC CONTREPOIDS TITAN ULTRA

T046012 TITAN ULTRA MILLS FORCEPS INT 0,75 X DIAM EXT 1,2 X 210 MM DIAMOND JAWS WITH PLATFORM ROUND BODY DOUBLE ARTICULATION WITH COUNTERWEIGHT



Garantie totale
2 ANS
sans conditions

TITAN ULTRA

1,2 X 1,8 MM

T046015

PINCE 0,5 X 0,6 X 210 MM DROITE MORS
DIAMANTES CORPS ROND AVEC CONTREPOIDS
TITAN ULTRA

T046010 TITAN ULTRA FORCEPS 0,5 X 0,6 X 210 MM
STRAIGHT DIAMOND JAWS WITH PLATFORM
ROUND BODY WITH COUNTERWEIGHT



COURBE
CURVED
T046009

PINCE 0,4 X 6 X 180 MM 1 X 2 GRIFFES
COUDEE 90° CORPS ROND TUNGSTENE A
PLATEAU TITAN ULTRA

T045969 TITAN ULTRA FORCEPS 0,4 X 6 X 180 MM
1 X 2 TEETH ANGLED 90° ROUND BODY
TUNGSTEN WITH PLATFORM

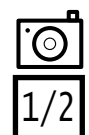

PINCE 0,5 X 0,4 X 6 X 185 MM DROITE CORPS ROND MOTRS
DIAMANTES A PLATEAU AVEC CONTREPOIDS TITAN ULTRA

T045973 TITAN ULTRA FORCEPS 0,5 X 0,4 X 6 X 185 MM STRAIGHT ROUND
BODY DIAMOND JAWS WITH PLATFORM WITH COUNTERWEIGHT

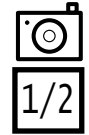
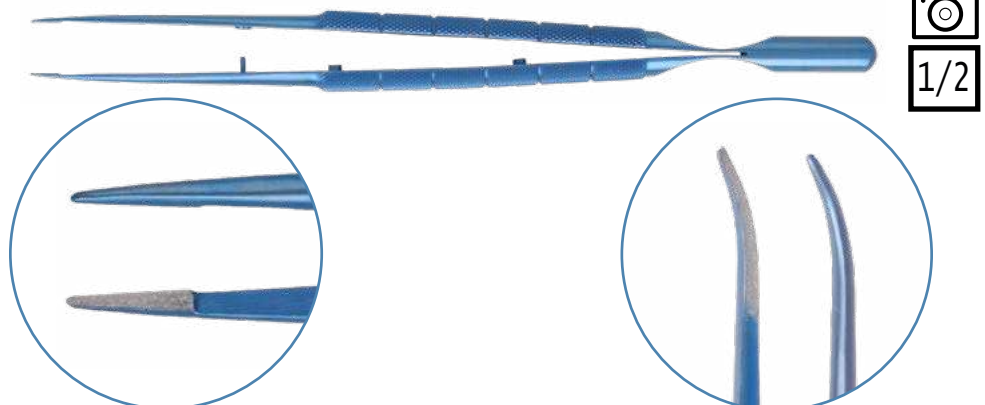

COURBE
CURVED
T045972



TOUS NOS PRODUITS TITAN ULTRA SONT GARANTIS 2 ANS ET REMPLACÉS SANS CONDITIONS

SPÉCIFICITÉS :

Les mors **diamantés** assurent une meilleure préhension et sont non traumatisants

Non magnétique, anticorrosif

Tous nos porte aiguilles **TITAN ULTRA** sont équipés d'un verrou, pouvant être utilisé ou non selon la convenance du praticien



!!! AVANTAGE !!!

**2 X PLUS LEGER QUE
L'ACIER INOXYDABLE**

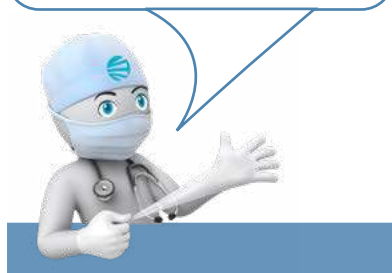

Sans verrou



Avec verrou

TITAN - PORTE AIGUILLE CORPS PLAT

www.in-surg.fr

T

TITAN - NEEDLE HOLDER FLAT BODY

PORTE AIGUILLE 0,5 X 0,8 X 200 MM COURBE
MORS DIAMANTES EN BAIONNETTE CORPS
PLAT TITAN ULTRA

T046018 TITAN ULTRA NEEDLE HOLDER 0,5 X 0,8 X
200 MM CURVED DIAMOND JAWS BAYONET
FLAT BODY

PORTE AIGUILLE 0,85 X 1 X 185 MM DROIT
MORS DIAMANTES CORPS PLAT TITAN ULTRA

T046025 TITAN ULTRA NEEDLE HOLDER 0,85 X 1 X
185 MM STRAIGHT DIAMOND JAWS FLAT
BODY

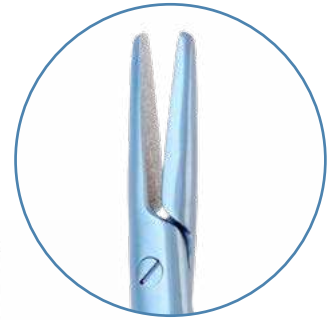

DROIT
STRAIGHT
T046019



COURBE
CURVED
0,8 X 1 X 185 MM
T046024

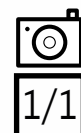

TITAN - PORTE AIGUILLE CORPS PLAT

TITAN - NEEDLE HOLDER FLAT BODY

PORTE AIGUILLE 0,6 X 0,6 X 165 MM COURBE MORS DIAMANTES CORPS PLAT TITAN ULTRA
T046020 TITAN ULTRA NEEDLE HOLDER 0,6 X 0,6 X 165 MM CURVED DIAMOND JAWS FLAT BODY

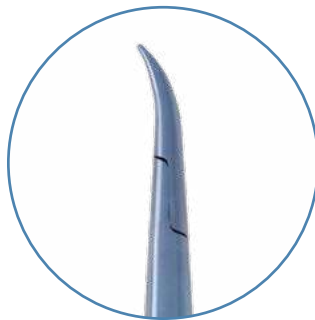

COURBE
CURVED



DROIT
STRAIGHT

0,6 X 0,6 MM

T046020

T046021

0,8 X 0,9 MM

T046023

T046022

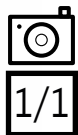

PORTE AIGUILLE 0,85 X 1 X 210 MM DROIT MORS DIAMANTES CORPS PLAT TITAN ULTRA
T046027 TITAN ULTRA NEEDLE HOLDER 0,85 X 1 X 210 MM STRAIGHT DIAMOND JAWS FLAT BODY



COURBE
CURVED



DROIT
STRAIGHT

0,85 X 1 X 210 MM

T046026

T046027

1,2 X 1,5 X 230 MM

T046028

0,85 X 1 X 240 MM

T046029

T046030

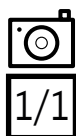

TITAN - PORTE AIGUILLE CORPS ROND

TITAN - NEEDLE HOLDER ROUND BODY

PORTE AIGUILLE 0.3 X 0.3 X 135 MM COURBE MORS DIAMANTES CORPS ROND TITAN ULTRA
T046032 *TITAN ULTRA NEEDLE HOLDER 0.3 X 0.3 X 135 MM CURVED DIAMOND JAWS ROUND BODY*

IN'SURG
TITAN ULTRA

Garantie
totale
2 ANS
sans conditions

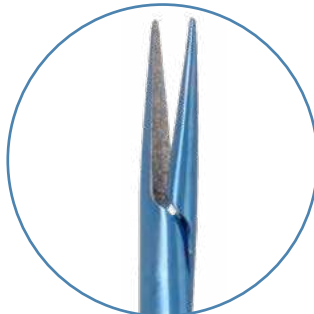

DROIT
STRAIGHT
T046033

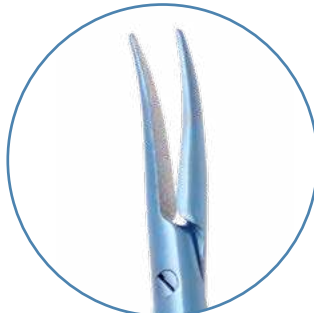

COURBE
CURVED
T046032



ANGULE
ANGULATED
T046031

PORTE AIGUILLE 0.3 X 0.4 X 150 MM COURBE MORS DIAMANTES CORPS ROND TITAN ULTRA
T046036 TITAN ULTRA NEEDLE HOLDER 0.3 X 0.4 X 150 MM CURVED DIAMOND JAWS ROUND BODY

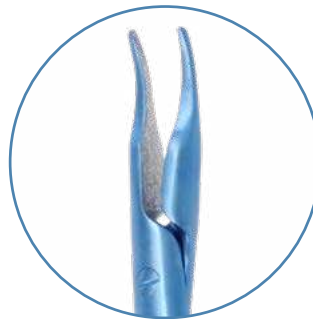
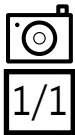

COURBE
CURVED

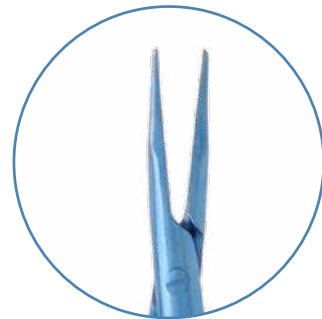

DROIT
STRAIGHT

0,3 X 0,4 MM

T046036

T046037

0,6 X 0,6 MM

T046038

T046039

TITAN - PORTE AIGUILLE CORPS ROND

TITAN- NEEDLE HOLDER ROUND BODY

PORTE AIGUILLE 0.4 x 0.4 x 160 MM DROIT MORS DIAMANTES CORPS ROND TITAN ULTRA

T046041 TITAN ULTRA NEEDLE HOLDER 0.4 x 0.4 x 160 MM STRAIGHT DIAMOND JAWS ROUND BODY



Garantie
totale
2 ANS
sans conditions

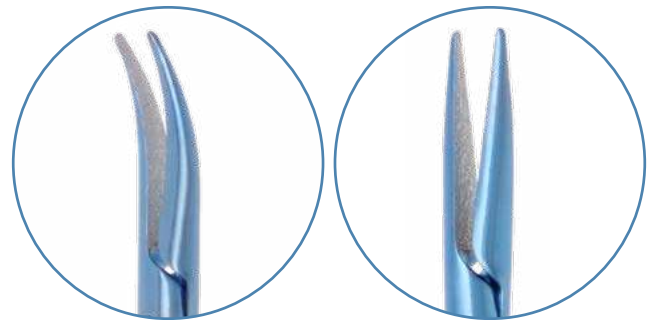
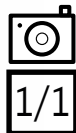

COURBE
CURVED

DROIT
STRAIGHT

0,45 X 0,55 X 145 MM

T046034

T046035

0,4 X 0,4 X 160 MM

T046040

T046041

0,3 X 0,4 X 180 MM

T046042

T046043

0,8 X 0,8 X 185 MM

T046044

T046045

PORTE AIGUILLE 0.6 X 0.6 X 200 MM COURBE MORS DIAMANTES CORPS ROND TITAN ULTRA

T046048 TITAN ULTRA NEEDLE HOLDER 0.6 X 0.6 X 200 MM CURVED DIAMOND JAWS ROUND BODY

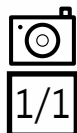

COURBE
CURVED

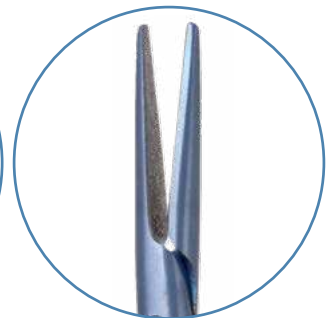

DROIT
STRAIGHT

- 0,4 X 0,6 X 200 MM
- 0,6 X 0,6 X 200 MM
- 0,6 X 0,7 X 210 MM
- 0,85 X 1 X 210 MM
- 0,6 X 0,7 X 230 MM
- 0,85 X 1 X 230 MM

- T046046**
- T046048**
- T046050**
- T046052**
- T046054**
- T046056**

- T046047**
- T046049**
- T046051**
- T046053**
- T046055**
- T046057**

TITAN - PORTE AIGUILLE CORPS ROND

TITAN - NEEDLE HOLDER ROUND BODY

PORTE AIGUILLE 0,7 x 0,6 x 210 MM COURBE MORS DIAMANTES DOUBLE
ARTICULATION CORPS ROND AVEC CONTREPOIDS TITAN ULTRA

T046062 TITAN ULTRA NEEDLE HOLDER 0,7 x 0,6 x 210 MM CURVED DIAMOND
JAWS DOUBLE ARTICULATION ROUND BODY WITH COUNTERWEIGHT



COURBE
CURVED

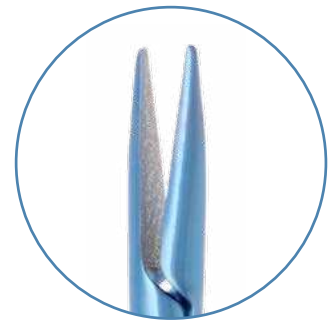

DROIT
STRAIGHT

0,6 X 0,6 X 185 MM

T046058

T046059

0,7 X 0,6 X 210 MM

T046062

T046063

1 X 0,9 X 210 MM

T046060

T046061

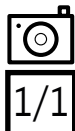

TITAN - RASPATORY

RUGINE SUR MANCHE TITANE 2 x 220 MM
COURBE BAIONNETTE TITAN ULTRA

T046093 *TITAN ULTRA RASPATORY ON THE
HANDLE TITAN 2 x 220 MM CURVED
BAYONET*



RUGINE SUR MANCHE TITANE 3 x 220 MM
DROITE TITAN ULTRA

T046094 *TITAN ULTRA RASPATORY ON THE HANDLE
TITANE 3 x 220 MM STRAIGHT*



 **IN'SURG**
TITAN ULTRA

**Garantie
totale
2 ANS**
sans conditions

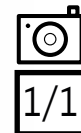
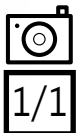

SET VASCULAIRE TITAN ULTRA

T046095 TITAN ULTRA VASCULAR SET

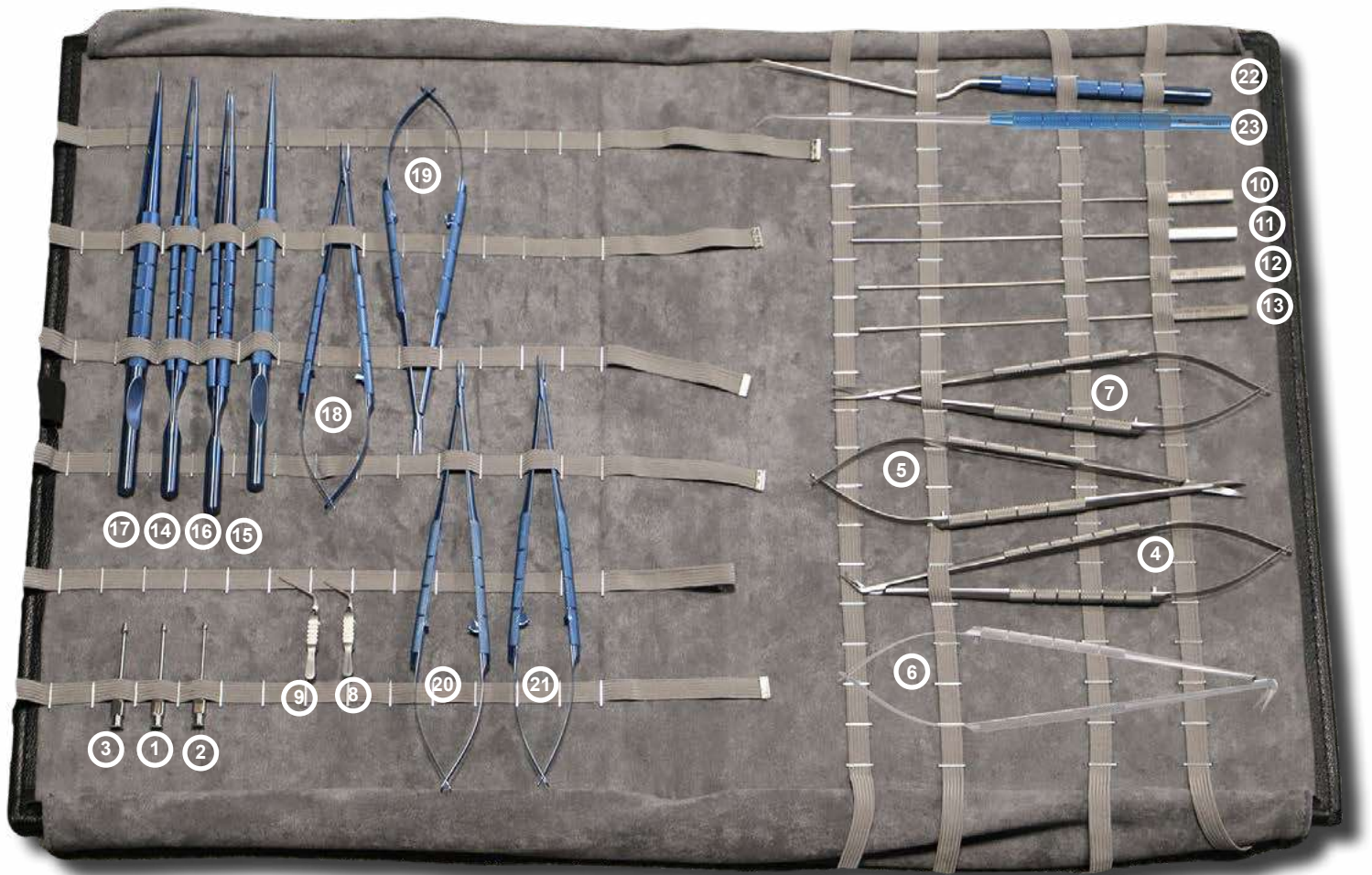

Porte instruments non fourni.

T045898 ①

CANULE DEBAKEY 2,5 x 48 MM
TITAN ULTRA
*TITAN ULTRA DEBAKEY SUCTION
CANNULA 2,5 x 48 MM*

T045899 ②

CANULE DEBAKEY 3 x 48 MM
TITAN ULTRA
*TITAN ULTRA DEBAKEY SUCTION
CANNULA 3 x 48 MM*

T045900 ③

CANULE DEBAKEY 3,5 x 48 MM
TITAN ULTRA
*TITAN ULTRA DEBAKEY SUCTION
CANNULA 3,5 x 48 MM*

T045936 ④

CISEAUX 200 MM COUDE A 45°
CORONAIRE CORPS ROND
TITAN ULTRA
*TITAN ULTRA SCISSOR 200 MM ANGLED
45° CORONARY ROUND BODY*

T045937 ⑤

CISEAUX 200 MM COUDE A 60°
CORONAIRE CORPS ROND TITAN ULTRA
*TITAN ULTRA SCISSOR 200 MM ANGLED
60° CORONARY ROUND BODY*

T045939 ⑥

CISEAUX 200 MM COUDE A 120°
CORONAIRE CORPS ROND
TITAN ULTRA
*TITAN ULTRA SCISSOR 200 MM ANGLED
120° CORONARY ROUND BODY*

T045940 ⑦

CISEAUX 0.6 X 0.3 X 200 MM COURBE
MOUSSE VASCULAIRE CORPS ROND
TITAN ULTRA
*TITAN ULTRA SCISSOR 0.6 X 0.3 X 200 MM
CURVED BLUNT VASCULAR ROUND BODY*

T045958 ⑧

CLAMP BULLDOG 12 X 47 MM COUDE INOX
TITAN ULTRA
*TITAN ULTRA BULLDOG CLAMP
12 X 47 MM CURVED STAINLESS STEEL*

T045960 ⑨

CLAMP BULLDOG 17 X 47 MM
COUDE INOX TITAN ULTRA
*TITAN ULTRA BULLDOG CLAMP
17 X 47 MM CURVED STAINLESS STEEL*

T045961 ⑩

DILATATEUR DEBAKEY CORON.
1 X 180 MM TITAN ULTRA
*TITAN ULTRA DEBAKEY DILATOR
CORON. 1 X 180 MM*

T045962 ⑪

DILATATEUR DEBAKEY CORON.
1,5 X 180 MM TITAN ULTRA
*TITAN ULTRA DEBAKEY DILATOR
CORON. 1,5 X 180 MM*

T045963 ⑫

DILATATEUR DEBAKEY CORON.
2 X 180 MM TITAN ULTRA
*TITAN ULTRA DEBAKEY DILATOR
CORON. 2 X 180 MM*

T045964 ⑬

DILATATEUR DEBAKEY CORON.
2,5 X 180 MM TITAN ULTRA
*TITAN ULTRA DEBAKEY DILATOR
CORON. 2,5 X 180 MM*

T046011 ⑭

PINCE DEBAKEY 1 X 1 X 210 MM CORPS
ROND AVEC CONTREPOIDS TITAN
ULTRA
*TITAN ULTRA FORCEPS DEBAKEY
1 X 1 X 210 MM ROUND BODY WITH
COUNTERWEIGHT*

T046013 ⑮

PINCE MILLS DIAM INT 0,75 X DIAM EXT
1,2 X 210 MM MORS DIAMANTES A
PLATEAU CORPS ROND TITAN ULTRA
*TITAN ULTRA MILLS FORCEPS INT
0,75 X DIAM EXT 1,2 X 210 MM DIAMOND
JAWS WITH PLATFORM ROUND BODY*

T046009 ⑯

PINCE 0,5 X 0,6 X 210 MM COURBE MORS
DIAMANTES A PLATEAU CORPS ROND
AVEC CONTREPOIDS TITAN ULTRA
*TITAN ULTRA FORCEPS 0,5 X 0,6 X 210 MM
CURVED DIAMOND WITH PLATFORM JAWS
ROUND BODY WITH COUNTERWEIGHT*

T046010 ⑰

PINCE 0,5 X 0,6 X 210 MM DROITE MORS
DIAMANTES CORPS ROND AVEC
CONTREPOIDS TITAN ULTRA
*TITAN ULTRA FORCEPS 0,5 X 0,6 X 210 MM
STRAIGHT DIAMOND JAWS WITH
PLATFORM ROUND BODY WITH
COUNTERWEIGHT*

T046044 ⑱

PORTE AIGUILLE 0.8 X 0.8 X 185 MM
COURBE MORS DIAMANTES CORPS
ROND TITAN ULTRA
*TITAN ULTRA NEEDLE HOLDER 0.8 X 0.8 X
185 MM CURVED DIAMOND JAWS ROUND
BODY*

T046045 ⑲

PORTE AIGUILLE 0.8 X 0.8 X 185 MM DROIT
MORS DIAMANTES CORPS ROND TITAN
ULTRA
*TITAN ULTRA NEEDLE HOLDER 0.8 X 0.8 X
185 MM STRAIGHT DIAMOND JAWS ROUND
BODY*

T046048 ⑳

PORTE AIGUILLE 0.6 X 0.6 X 200 MM
COURBE MORS DIAMANTES CORPS
ROND TITAN ULTRA
*TITAN ULTRA NEEDLE HOLDER
0.6 X 0.6 X 200 MM CURVED DIAMOND
JAWS ROUND BODY*

T046049 ㉑

PORTE AIGUILLE 0.6 X 0.6 X 200 MM DROIT
CORPS ROND TITAN ULTRA
*TITAN ULTRA NEEDLE HOLDER 0.6 X 0.6 X
200 MM STRAIGHT DIAMOND JAWS ROUND
BODY*

T046093 ㉒

RUGINE SUR MANCHE TITANE 2 x 220 MM
COURBE BAIONNETTE TITAN ULTRA
*TITAN ULTRA RASPATORY ON THE
HANDLE TITANE 2 x 220 MM CURVED
BAYONET*

T046094 ㉓

RUGINE SUR MANCHE TITANE 3 x 220 MM
DROITE TITAN ULTRA
*TITAN ULTRA RASPATORY ON THE
HANDLE TITANE 3 x 220 MM STRAIGHT*

TORD BROCHE DIAM INT 2,5 MM
T056106 TWIST PIN DIAM INT. 2,5 MM



SCREWDRIVER

TOURNEVIS HEXAGONAL 3,5 X 250 MM
MANCHE CELERON

T066109 *HEXAGONAL SCREWDRIVER
3,5 X 250 MM CELERON HANDLE*



T066108
2.5 X 250 MM

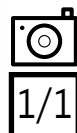

TOURNEVIS HEXAGONAL 4,5 X 250 MM
MANCHE CELERON

T066110 *HEXAGONAL SCREWDRIVER
4,5 X 250 MM CELERON HANDLE*

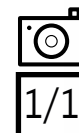

TOURNIQUET RUMEL DIAM 6,4 MM FLEXIBLE ADULTE

T076110 *RUMEL VASCULAR TOURNIQUET DIAM 6,4 MM FLEXIBLE ADULT*



T076111

STYLET DE RECHANGE
ADULTE

*STYLUS FOR RUMEL VASCULAR
TOURNIQUET ADULT*

T076112

TOURNIQUET ENFANT
DIAM 3,2 MM

*VASCULAR TOURNIQUET DIAM
3,2 MM CHILDREN*

T076113

STYLET DE RECHANGE
ENFANT

*STYLUS FOR TOURNIQUET
CHILDREN*

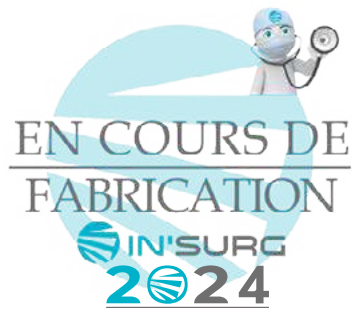

HAND DRILLS

TREPAN COMPLET AVEC 3 FRAISES POUR LA MAIN

T086114 *HAND DRILLS FOR HAND SURGERY COMPLETE WITH 3 BURRS*



TREPAN

HAND DRILLS

TREPAN DOYEN TOUT INOX L'UNITE

T086135 DOYEN DRILL BIT TOUT
STAINLESS STEEL UNITPERFORATEUR
PUNCH 60 MM

T086133

FRAISE CONIQUE
CONICAL BURR
Ø 14 MM

T086130

FRAISE
BURR
Ø 4 MM
Ø 8 MM
Ø 14 MM
Ø 16 MM

T086122

T086123

T086126

T086128

COURONNE
CROWN
Ø 15 MM
Ø 20 MM
Ø 25 MM
Ø 30 MM
Ø 35 MM

T086138

T086140

T086142

T086144

T086146

VIS DE BLOCAGE
LOCKING SCREW

T086137

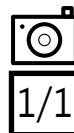

TREPAN HUDSON 240 MM A ENCLIQUETAGE L'UNITE
T086158 HUDSON DRILL BIT 240 MM QUICK CONNECTION UNIT



FRAISE
 BURR

Ø 9 MM

T086149

Ø 12 MM

T086150

Ø 16 MM

T086151

Ø 22 MM

T086152

PERFORATEUR
 CUSING 14 MM
 CUSHING PUNCH
 4,5 X 15 MM

T086153

PERFORATEUR
 ERRICO 16 MM
 ERRICO PUNCH
 4,5 X 15 MM

T086154

PERFORATEUR
 MAC KENZIE 13 MM
 MAC KENZIE PUNCH
 4,5 X 15 MM

T086155



TREPAN HUDSON 240 MM 4 FRAISES + RALLONGE

T086157 HUDSON DRILL BIT 240 MM
4 BURRS + EXTENSION



T086156
100 MM
RALLONGE
EXTENSION

GUIDE MECHE ADSON 150 MM PROTEGE DURE MERE

T086148 DRILL BIT FOR ADSON 150 MM TO PROTECT FOR THE DURA MATER

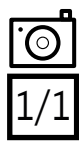

SOMMAIRE

VALVE	1261
<i>VALVE</i>	
VENTOUSE OBSTETRICALE	1276
<i>OBSTETRICAL VACUUM</i>	



V

RETRO 'SPECTIVE

Richard von VOLKMANN
(17 août 1830 - 28 novembre 1889)

était un **poète et chirurgien** allemand. Il réalisa **la première excision d'un carcinome du rectum** en 1878. Il décrit le **syndrome de Volkmann** en 1881, puis **invente une attelle et une cuillère qui portent son nom**. Aujourd'hui, son **traitement de la tuberculose articulaire** fait la gloire de la chirurgie préventive.



VALVE
VALVE

VALVE ALLISSON 40 X 300 MM

V016172 ALLISSON VALVE 40 X 300 MM

VALVE AUVARD 38 X 83 MM

V016173 AUVARD VALVE 38 X 83 MM

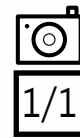
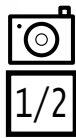

VALVE BREISKY 20 X 100 X 290 MM

V016177 BREISKY VALVE 20 X 100 X 290 MM



LARGEUR WIDTH	LONGUEUR LENGTH					
	290 MM	Y =	320 MM	Y =	350 MM	Y =
20 MM	V016177	100 MM	V016182	130 MM		
25 MM	V016178	100 MM	V016183	130 MM		
30 MM	V016179	100 MM	V016184	130 MM		
35 MM	V016180	100 MM	V016185	130 MM		
40 MM	V016181	100 MM	V016186	130 MM	V016187	160 MM

VALVE CZERNY 220 MM POUR RECTUM
V016189 CZERNY VALVE 220 MM FOR RECTUM



VALVE CHARRIER LARGUEUR 40 LONGEUR 60, 90, 120 MM JEU DE 3
V016188 CHARRIER VALVE WIDTH 40 LENGTH 60, 90, 120 MM SET OF 3

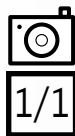

VALVE DEAVER 38 X 370 MM

V016195 DEAVER VALVE 38 X 370 MM

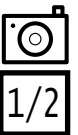

		LONGUEUR LENGTH				
		180 MM	200 MM	230 MM	330 MM	370 MM
LARGEUR WIDTH						
20 MM	V016190					
25 MM			V016191	V016192	V016194	V016193
38 MM						V016195
50 MM						V016196

**VALVE
VALVE**

VALVE VAGINALE DOYEN 29 X 80 MM PLATE
V016200 DOYEN VAGINA VALVE 29 X 80 MM FLAT

VALVE VAGINALE DOYEN 60 X 90 MM
V016208 DOYEN VALVE 60 X 90 MM

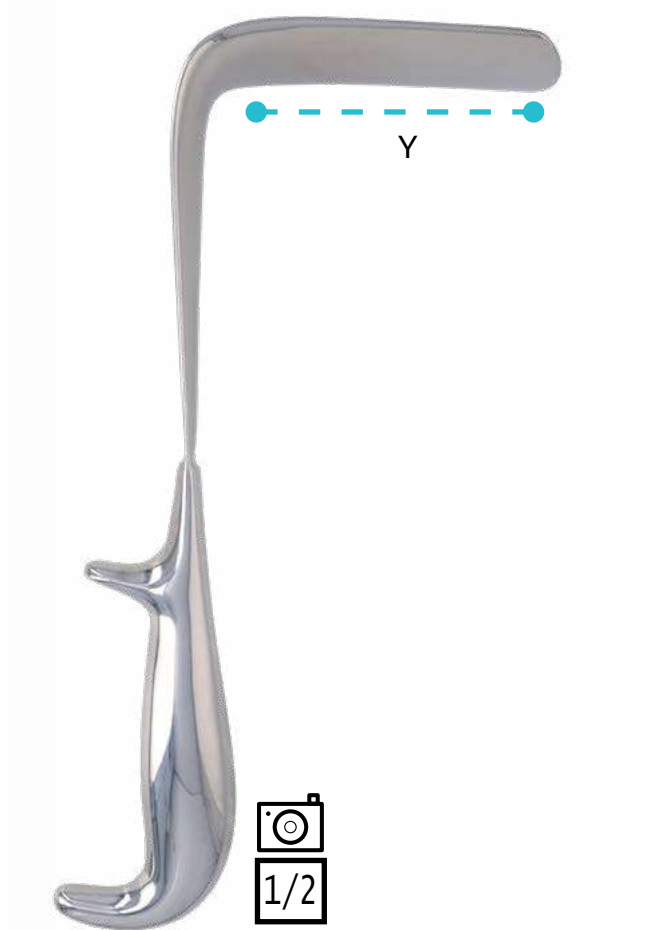
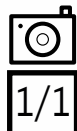

LARGEUR
WIDTH

Y= 55 MM Y= 60 MM Y= 90 MM Y = 120 MM

25 MM
30 MM
35 MM
45 MM
60 MM

V016199			
V016201			
		V016202	V016203
	V016204	V016205	V016206
	V016207	V016208	V016209

VALVE SUSPUBIENNE DOYEN 50 X 85 MM SUR MANCHE

V016198 DOYEN SUPRAPUBIC VALVE 50 X 85 MM ON THE HANDLE

VALVE DOYEN 60 X 200 MM PLASTIE

V016197 DOYEN PLASTIE VALVE 60 X 200 MM



VALVE HARRINGTON 40 X 127 X 320 MM

V016210 HARRINGTON VALVE 40 X 127 X 320 MM



V016211
62 X 127 MM

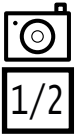

VALVE A POIDS JAYLE 40 X 60 MM

V016213 JAYLE VALVE WITH WEIGHT 40 X 60 MM

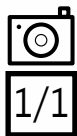

V016214
40 X 90 MM

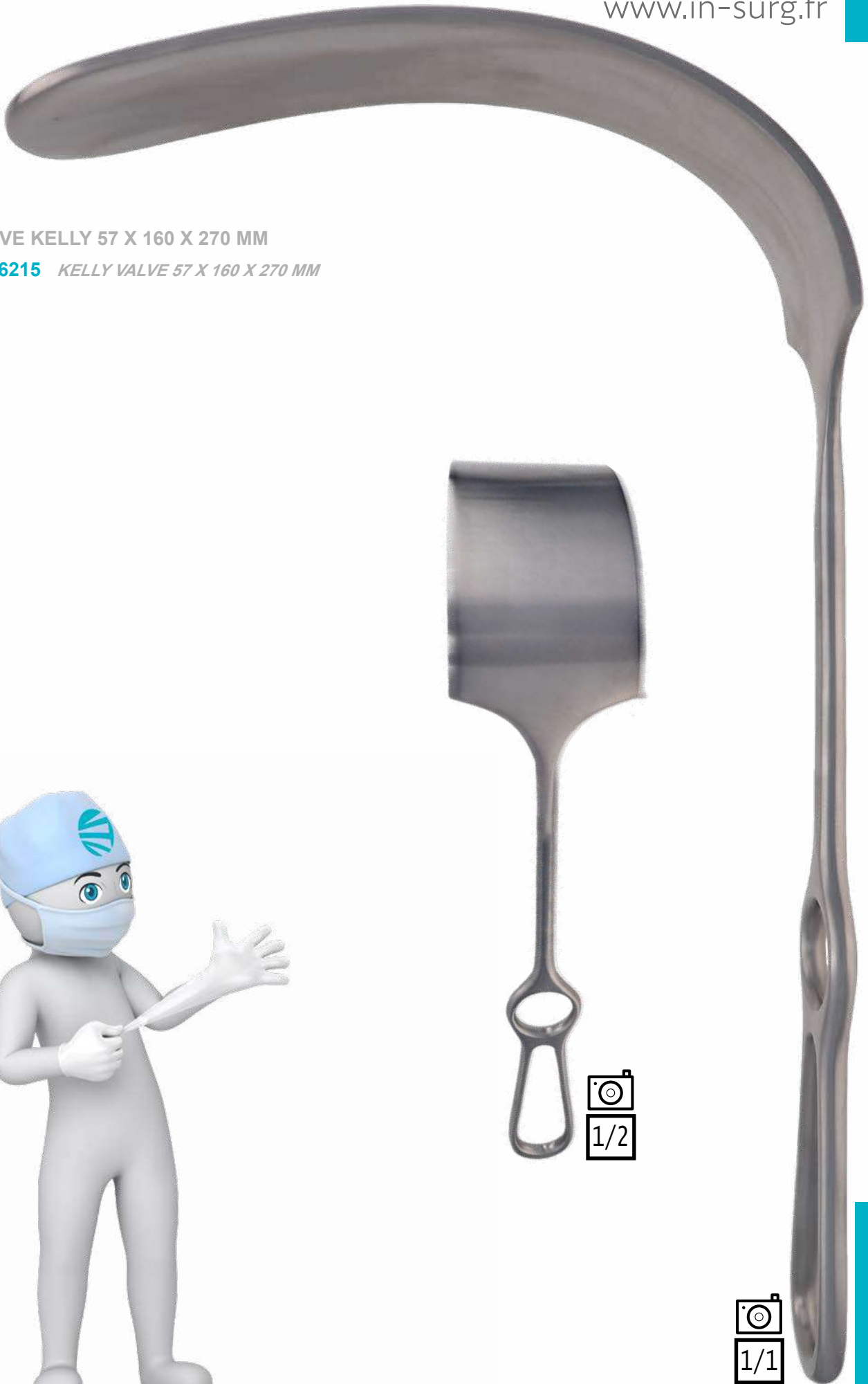

VALVE KELLY 57 X 160 X 270 MM

V016215 KELLY VALVE 57 X 160 X 270 MM

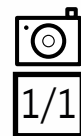
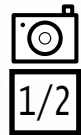

VALVE KOCHER 60 X 240 MM DEPRESSEUR

V016216 KOCHER VALVE 60 X 240 MM DEPRESSANT



VALVE TUFFIER 58 X 64 X 230 MM

V016220 TUFFIER VALVE 58 X 64 X 230 MM

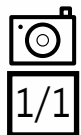

VALVE
VALVE

VALVE ST MARKS 45 X 35 & 60 X 130 X 290 MM
POUR RECTUM

V016218 ST MARKS VALVE 45 X 35 & 60 X 130 X 290 MM
FOR RECTUM

VALVE ST MARKS 45 X 60 & 60 X 180 X 325 MM
POUR RECTUM

V016219 ST MARKS VALVE 45 X 60 & 60 X 180 X 325 MM
FOR RECTUM

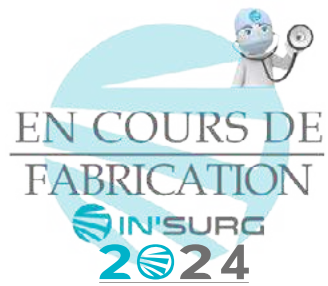

VALVE KRISTELLER 27 X 70 MM GALBEE

V016225 KRISTELLER VALVE 27 X 70 MM CURVED

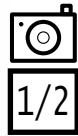

V016226
30 X 75 MM

V016227
36 X 90 MM

VALVE KRISTELLER 23 X 75 MM PLATE

V016228 KRISTELLER VALVE 23 X 75 MM FLAT



V016229
26 X 80 MM

V016230
26 X 115 MM

V016231
32 X 95 MM

V016232
32 X 115 MM

VALVE LEGUEU 35 X 270 MM DEPRESSEUR VESSIE

V016233 LEGEU VALVE 35 X 270 MM BLADDER DEPRESSANT

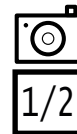

VALVE LERICHE BUGATTI 35 X 210 MM

V016235 LERICHE BUGATTI VALVE 35 X 210 MM

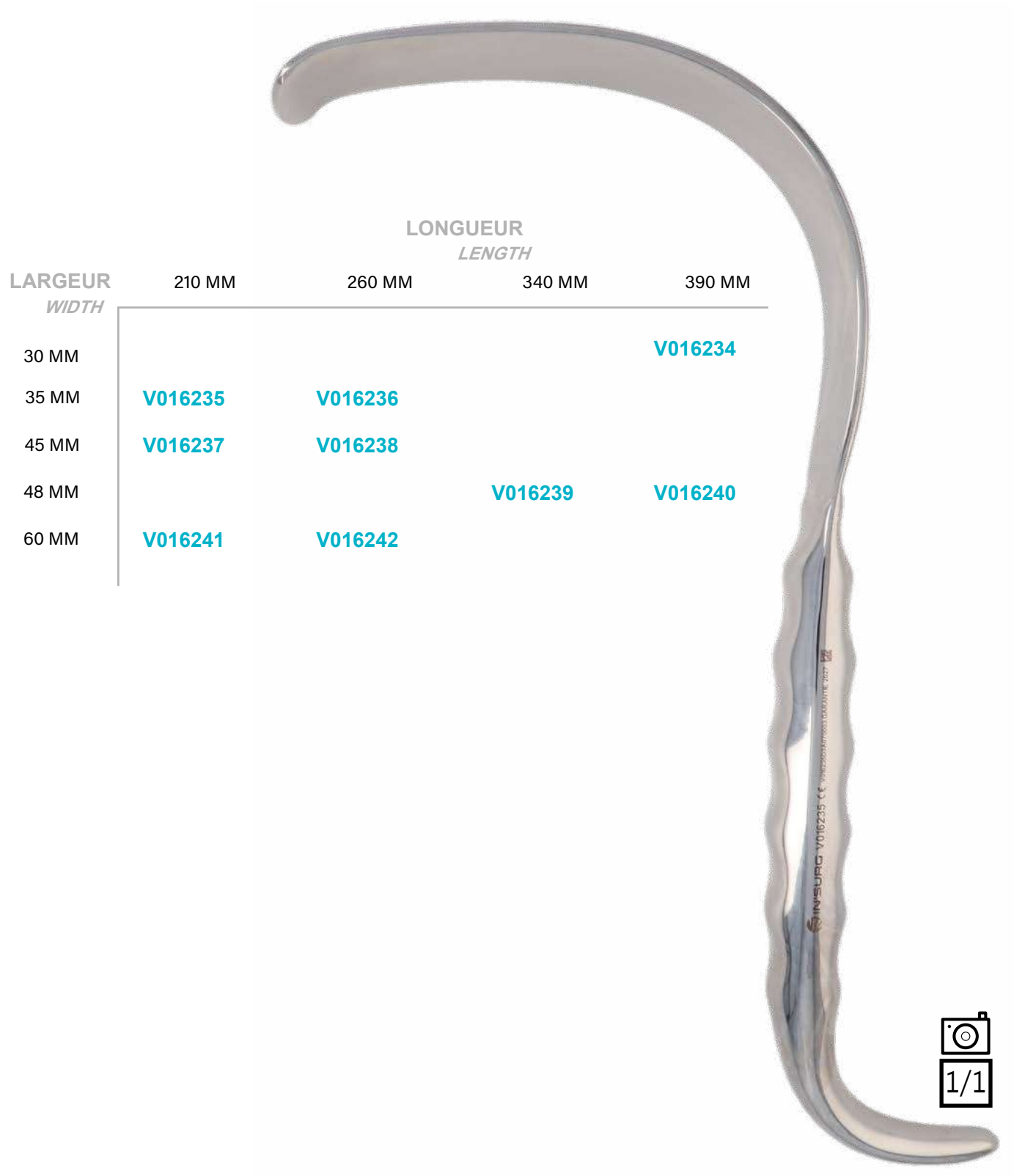

LARGEUR WIDTH	LONGUEUR LENGTH			
	210 MM	260 MM	340 MM	390 MM
30 MM				V016234
35 MM	V016235	V016236		
45 MM	V016237	V016238		
48 MM			V016239	V016240
60 MM	V016241	V016242		

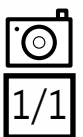

VALVE MANGIAGALLI 40 X 80 MM
V016243 MANGIAGALLI VALVE 40 X 80 MM



VALVE
VALVE

VALVE POLOSSON 45 X 290 MM AJOUREE
V016244 POLOSSON VALVE 45 X 290 MM
FENESTRATED

VALVE POLOSSON 45 X 265 MM PLEINE
V016246 POLOSSON VALVE 45 X 265 MM FULL



V016245
60 X 290 MM

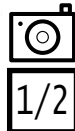

V016247
60 X 265 MM

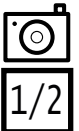

VENTOUSE OBSTETRICALE

OBSTETRICAL VACUUM

www.in-surg.fr



VENTOUSE OBSTETRICALE DIAM 40 MM L'UNITE

V026252 VACUUM EXTRACTOR DIAM 40 MM UNIT

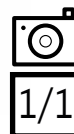

V026253
Ø 50 MM

LOT DE 5 DIAPHRAGMES POUR VENTOUSE OBSTETRICALE DIAM 40 MM

V026256 SET OF 5 DIAPHRAGMS FOR VACUUM EXTRACTOR DIAM 40 MM

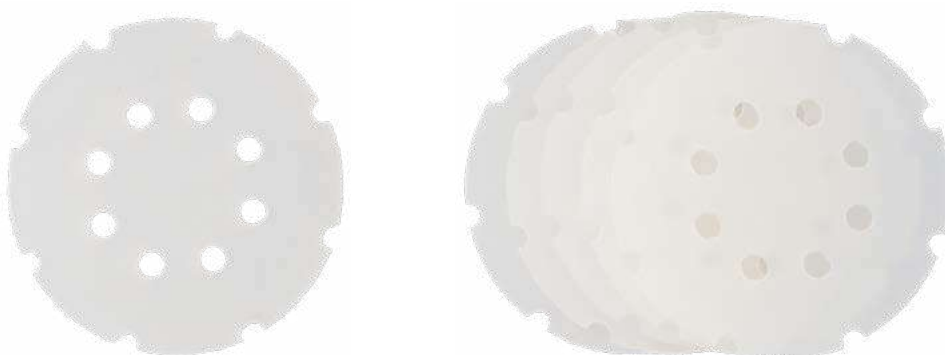

V026257
Ø 50 MM

POIGNEE DE TRACTION POUR VENTOUSE OBSTETRICALE L'UNITE

V026254 TRACTION HANDLE FOR VACUUM EXTRACTOR UNIT

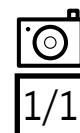

TUBE SILICONE POUR VENTOUSE OBSTETRICALE 3 X 2 M

V026255 SILICON TUBE FOR VACUUM EXTRACTOR 3 X 2 M





Le contenu de ce catalogue (les marques, les textes, les dessins, illustrations, présentations, ...) reste la propriété exclusive de la société IN'SURG.

Toute reproduction, représentation, modification, adaptation, et/ou traduction de ce catalogue, qu'elle soit totale ou partielle, à titre gratuit ou onéreux est interdite sans l'accord préalable de la société IN'SURG.

Les instruments présents dans ce catalogue sont des dispositifs médicaux, marqués CE, de classe I fabriqués par IN'SURG.

Nous vous invitons à lire attentivement les instructions figurant sur l'étiquette et/ou la notice et/ou la fiche technique pour s'assurer de la correcte utilisation des dispositifs.

Ce document est réservé aux professionnels de santé uniquement.

The content of this catalog (including the trademarks, the texts, the drawings, illustrations, layouts, ...) is, unless otherwise specified, the exclusive property of IN'SURG.

It is not allowed to reproduce, represent, display, modify, adapt an/or translate - whether in part or in whole and whether for free or for financial consideration - the catalog and/or any material composing the catalog, without the prior and written consent of IN'SURG.

The instruments in this catalog are medical devices, CE marked, of classes I manufactured by IN'SURG.

Before any use, please read carefully the instructions on the label and/or the instructions and/or the technical sheet to ensure the correct use of the devices.

Document reserved for healthcare professionals only.

Concept et design, Concept and design : IN'SURG

Tous droits réservés - All right reserved

Photos et illustrations non contractuelles - Photos and pictures are not contractual